

Appendices

**ADVERTISED
PLAN**

**This copied document to be made available
for the sole purpose of enabling
its consideration and review as
part of a planning process under the
Planning and Environment Act 1987.
The document must not be used for any
purpose which may breach any
copyright**

Appendix A

Landscape and Visual Impact Assessment

This copied document to be made available for the sole purpose of enabling its consideration and review as part of a planning process under the Planning and Environment Act 1987. The document must not be used for any purpose which may breach any copyright

ADVERTISED
PLAN



Tatura Solar Farm

Landscape and Visual Impact Assessment

Goulburn Valley Water

12 March 2024

This copied document to be made available for the sole purpose of enabling its consideration and review as part of a planning process under the Planning and Environment Act 1987. The document must not be used for any purpose which may breach any copyright

ADVERTISED PLAN

ADVERTISED PLAN

This copied document to be made available for the sole purpose of enabling its consideration and review as part of a planning process under the Planning and Environment Act 1987. The document must not be used for any purpose which may breach any copyright

GHD Pty Ltd | ABN 39 008 488 373

180 Lonsdale Street, Level 9

Melbourne , VIC 3000, Australia

T 61-3-8687 8000 | F 61-3-8687 8522 | E melmail@ghd.com | ghd.com

Printed date	12/03/2024 5:22:00 PM
Last saved date	12 March 2024 5:22 PM
File name	https://projectsportal.ghd.com/sites/pp17_03/goulburnvalleywaters/ProjectDocs/LVIA/12579414_GVWSF_LVIA_Tatura.docx
Author	Brenda Perez, Ed Robinson
Project manager	Jake Stones
Client name	Goulburn Valley Water
Project name	Tatura Solar Farm
Document title	Tatura Solar Farm Landscape and Visual Impact Assessment
Revision version	Rev 01
Project number	12579414

Document status

Status Code	Revision	Author	Reviewer		Approved for issue		
			Name	Signature	Name	Signature	Date
S4	0	B Perez E Robinson	S Rae		M Goode		12/03/2024

© GHD 2024

This document is and shall remain the property of GHD. The document may only be used for the purpose for which it was commissioned and in accordance with the Terms of Engagement for the commission. Unauthorised use of this document in any form whatsoever is prohibited.

ADVERTISED PLAN

Acknowledgement of Country

GHD acknowledges Aboriginal and Torres Strait Islander peoples as the Traditional Custodians of the land, water and sky throughout Australia on which we do business. We recognise their strength, diversity, resilience and deep connections to Country. We pay our respects to Elders of the past, present and future, as they hold the memories, knowledges and spirit of Australia. GHD is committed to learning from Aboriginal and Torres Strait Islander peoples in the work we do.

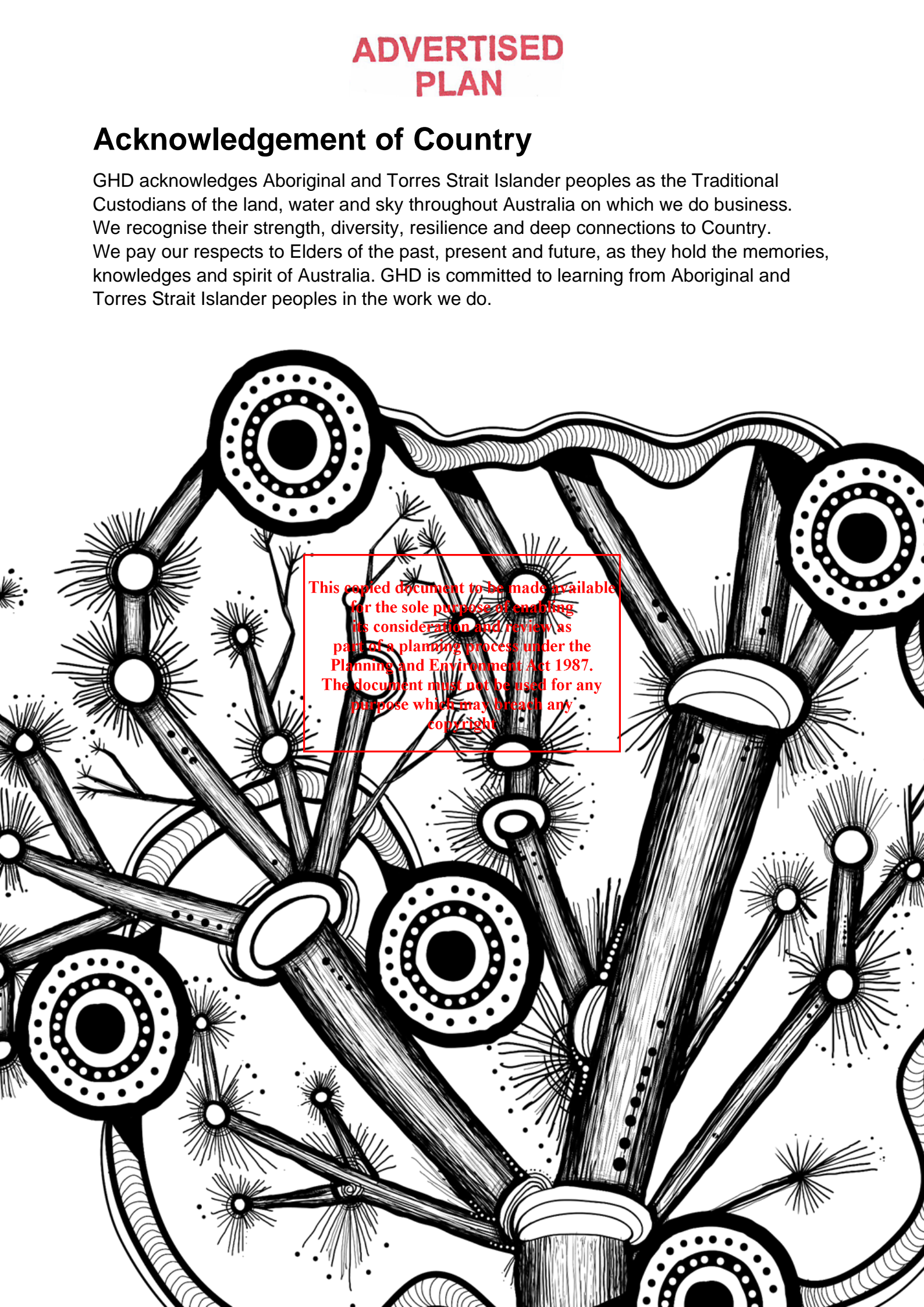

This copied document to be made available for the sole purpose of enabling its consideration and review as part of a planning process under the Planning and Environment Act 1987. The document must not be used for any purpose which may breach any copyright.

Executive summary

ADVERTISED PLAN

Introduction

Goulburn Valley Water (GVW) engaged GHD Pty Ltd (GHD) to undertake a Landscape and Visual Impact Assessment (LVIA) for the proposed solar farm at Dhurringile Road in Tatura, within the Tatura Wastewater Management Facility (WMF) site. Goulburn Valley Water (GVW) is seeking to install a large-scale solar facility within its Tatura Wastewater Management Facility (WMF) site. The intent of the solar photovoltaic (PV) system is to provide GVW with maximum energy yield so that GVW can offset their carbon footprint and generate revenue by selling electricity to the market. The Study Area for this report is generally confined to the likely extent of visibility of the Project within the surrounding context (approximately 5 km radius from the site).

Method

This assessment is informed by a desktop review, site inspection (on the 20th November 2023) and identified landscape character units and values. Due to the project's rural setting multiple sensitive receptors were identified within the assessment, including residents and road users.

The LVIA considers potential impacts of the proposed works from seven viewpoints (sensitive receptor locations) and two Landscape Character Areas. The findings of the assessment include recommendations and management measures to inform the design process and reduce potential negative impacts of the Project.

Proposal Summary

The project will include a large scale solar photovoltaic (PV) generation plant, high voltage (HV) infrastructure integration and reticulation systems comprising of the following:

- Fixed tilt or Single Axis Tracking (SAT) PV arrays located within GVW land, and ancillary infrastructure
- Control and switching room building
- Associated civil and structural works at the Solar Farm
- Integration into the DNSP electrical network including HV cabling (above and underground), conduits, pits (a substantial portion of this being in GVW land)
- Access roads and pavement
- Landscaping (extent of landscaping to be determined)
- Security fencing at all perimeter boundaries to restrict access

This copied document to be made available for the sole purpose of enabling consideration and review as part of a planning process under the Planning and Environment Act 1987. The document must not be used for any purpose including breaching copyright

LVIA Findings

The Project site and surrounding topography is characterised by a relatively flat landscape with gentle slopes towards the numerous irrigation channels. The landscape is characterised by irrigation channels and agrarian fields supporting diverse farming industries and typically has a sense of openness and vastness on slightly undulating topography. A total of two landscape character areas were identified within the study area: Farmland (LCA1) and Tatura Township (LCA2). Impacts on LCA1 were deemed as **Low**, associated with the modified agricultural landscapes with a presence of existing infrastructure. Impacts on LCA2 were generally **Negligible**. Overall, this assessment found there to be no significant landscape character impacts arising from the project. Sensitive visual receptors in the study area include road users, residents, and outdoor workers. Seven viewpoint locations were chosen for assessment. The assessment found that the visual impacts ranged from **Moderate to Negligible**. The most significant impacts were **Moderate-Low** within the vicinity of **VP07** (Toolamba-Rushworth Road) due to the magnitude of change and the proximity to the project.

Recommendations and Management Measures

The following section recommends mitigation measures that respond to issues arising within the assessment that have potential to adversely impact on the character of the landscape or views from nearby sensitive visual receptors. The following mitigation recommendations address the most visual elements of the project as well as referencing any relevant considerations drawn from the legislation and policy review.

General considerations for the detailed design phase include:

- Utilise design strategies to minimise the visual prominence of new components affecting views to and from the Dhurringile Road and Toolamba-Rushworth Road
- Ensure Project design, siting and materiality is of high quality and sympathetic to the existing heritage and contributes positively to the existing landscape character values

On-site mitigation recommendations

- Retain vegetation
- Perimeter screen planting
- Material selection

Construction activity and storage

- Take all practical measures to ensure construction equipment, stockpiles of stored materials, and other visible elements are located in the construction laydown area near the sensitive receptors
- Fencing for the compound site is to include hoarding or screening material
- The site compound will be kept tidy and general tidiness will be maintained at the end of each shift
- All materials and equipment will be stored within the site compound or within designated work areas

Conclusion

The recommendations and management measures provided within the LVIA should be considered within the design process to reduce the landscape and visual impacts of the Project.

This report is subject to, and must be read in conjunction with, the limitations set out in section 1.4 and the assumptions and qualifications contained throughout the Report.

ADVERTISED PLAN

**This copied document to be made available
for the sole purpose of enabling
its consideration and review as
part of a planning process under the
Planning and Environment Act 1987.
The document must not be used for any
purpose which may breach any
copyright**

Contents

1. Introduction		ADVERTISED PLAN	1
1.1	Overview of the project		1
1.2	Purpose and scope of this report		1
1.3	Report structure		2
1.4	Limitations		2
1.5	Assumptions		3
2. Methodology			4
2.1	Standards and guidance		4
2.2	Study area		4
2.3	Legislation and policy context		6
2.4	Existing landscape and visual environment		6
	2.4.1 Desktop analysis of the project, landscape and visual environment		6
	2.4.2 Site inspection		6
	2.4.3 Description of existing landscape and visual environment		6
2.5	Landscape impact assessment		7
	2.5.1 Landscape Character Areas		7
	2.5.2 Landscape effects		8
2.6	Visual impact assessment		9
	2.6.1 Viewpoint selection		9
	2.6.2 Visual effects		10
2.7	Significance of impact		11
2.8	Panorama and photomontages		11
2.9	Cumulative impacts		12
	2.9.1 Study area for cumulative impact assessment		12
	2.9.2 Criteria definition		12
2.10	Mitigation measures and recommendations		14
2.11	Response to key legislation and policy		14
2.12	Stakeholder engagement		14
2.13	Assumptions and limitations		14
3. Project description			15
3.1	The project site		15
3.2	Project overview		17
	3.2.1 Construction phase		17
	3.2.2 Operation phase		17
	3.2.3 Buildings and above ground infrastructure		18
	3.2.4 Access roads and pavements		18
4. Legislation and policy context			20
4.1	State legislation and policy		20
	4.1.1 Planning and Environment Act 1987		20
	4.1.2 Victorian Planning Policy Framework (PPF)		20
4.2	Local legislation, policy, and guiding documents		21
	4.2.1 Local Planning Policy Framework – Greater Shepparton Planning Scheme		21
	4.2.1.1 Zoning and overlays		21

This copied document to be made available for the sole purpose of enabling its consideration and review as part of a planning process under the Planning and Environment Act 1987. The document must not be used for any purpose which may breach any copyright

4.3	Other relevant policy	22
4.3.1	Greater Shepparton 2030 strategy	22
5.	Existing landscape and visual environment	23
5.1	Land use and built form	23
5.2	Topography and hydrology	23
5.3	Vegetation	23
5.4	Visual analysis	27
5.4.1	Sensitive visual receptors	27
5.4.2	Key visual features	27
6.	Landscape impact assessment	28
6.1	Landscape character area 1: Tatura Township	30
6.2	Landscape character area 2: Farmland	33
7.	Visual impact assessment	36
7.1	Viewpoint selection	36
7.2	Viewpoint location 01 (VP01) Dhurringile Road	38
7.3	Viewpoint location 02 (VP02) Toolamba-Rushworth Road	40
7.4	Viewpoint location 03 (VP03) Toolamba-Rushworth Road	42
7.5	Viewpoint location 04 (VP04) Dhurringile Road	44
7.6	Viewpoint location 05 (VP05) Murton Road	46
7.7	Viewpoint location 06 (VP06) Pogue Road	48
7.8	Viewpoint location 07 (VP07) Toolamba-Rushworth Road	50
8.	Cumulative impact assessment	52
8.1	Greater Shepparton Solar Farm Proposals	52
8.2	Tatty Solar Farm utility installation	52
9.	Mitigation measures and recommendations	53
9.1	General recommendations	53
9.2	Onsite mitigation recommendations	53
9.2.1	Retain vegetation	53
9.2.2	Perimeter screen planting	53
9.2.3	Material selection	53
9.2.4	Construction activity and storage	53
10.	Response to key legislation and policy	54
11.	Conclusion	55
12.	References	57

**This copied document to be made available
for the sole purpose of enabling
its consideration and review as
part of a planning process under the
Planning and Environment Act 1987.
The document must not be used for any
purpose which may breach any
copyright**

**ADVERTISED
PLAN**

Table index

Table 2.1	Landscape value	7
Table 2.2	Landscape susceptibility to change	8
Table 2.3	Magnitude of change criteria (landscape)	9
Table 2.4	Sensitivity to change criteria (visual)	10
Table 2.5	Magnitude of change criteria (visual)	11
Table 2.6	Significance of impact matrix (landscape and visual)	11
Table 3.1	Key proposed buildings and above ground infrastructure	18

Table 6.1	Key characteristics of LCA1	31
Table 6.3	Key characteristics of LCA2	34
Table 6.4	Landscape impact assessment	35
Table 7.1	Viewpoint locations	36
Table 7.2	Viewpoint location VP01 assessment	39
Table 7.3	Viewpoint location VP02 assessment	41
Table 7.4	Viewpoint location VP03 assessment	43
Table 7.5	Viewpoint location VP04 assessment	45
Table 7.6	Viewpoint location VP05 assessment	46
Table 7.7	Viewpoint location VP06 assessment	49
Table 7.8	Viewpoint location VP07 assessment	51
Table 10.1	Relevant legislation and policy	54
Table 11.1	Summary of impacts to landscape character impacts	55
Table 11.2	Summary of Visual impacts	55

This copied document to be made available for the sole purpose of enabling its consideration and review as part of a planning process under the Planning and Environment Act 1987. The document must not be used for any purpose which may breach any copyright

Figure index

Figure 2.1	Study Area	5
Figure 3.1	Project location plan	16
Figure 3.2	Proposed site layout plan	19
Figure 5.1	Land use and built form	24
Figure 5.2	Topography and hydrology	25
Figure 5.3	Vegetation	26
Figure 6.1	Landscape character area	29
Figure 7.1	Viewpoint location	37
Figure 7.2	VP01 location map	38
Figure 7.3	Photomontage showing proposed view from Dhurringile Road	38
Figure 7.4	Redline overlay showing proposed view from Dhurringile Road	39
Figure 7.6	VP02 location map	40
Figure 7.7	Photomontage showing proposed view from Toolamba -Rushworth Road	40
Figure 7.8	Redline overlay showing proposed view from Toolamba-Rushworth Road	41
Figure 7.9	VP03 location map	42
Figure 7.10	VP04 location map	44
Figure 7.11	VP05 location map	46
Figure 7.12	VP06 location map	48
Figure 7.13	VP07 location map	50
Figure 7.14	Photomontage showing proposed view from Toolamba-Rushworth Road	50
Figure 7.15	Redline overlay showing proposed view from Toolamba-Rushworth Road	51

**ADVERTISED
PLAN**

Photo index

Photo 6.1	View from Murton Road, Tatura looking north showing an example of the residential buildings of the town	30
Photo 6.2	View from O'Reilly Road, Tatura facing north showing Tatura Fire Station	30
Photo 6.3	View from Ross Street, Tatura looking north west showing the water tower	30

Photo 6.4	View from Ross Street, Tatura looking north showing example of the industrial area	30
Photo 6.5	View from Hogan Street, Tatura showing the main Highstreet through the centre of the township	30
Photo 6.6	View from Hogan Street, Tatura showing the church as one of the public buildings located throughout the town,	30
Photo 6.7	View from Dhurringile Road facing west showing agricultural fields	33
Photo 6.8	View from Dhurringile Road facing east showing agricultural related infrastructure	33
Photo 6.9	View from Pogue Road facing north showing extensive agricultural fields	33
Photo 6.10	View from Toolamba - Rushworth Road facing north showing irrigation channels associated with agricultural practices	33
Photo 6.11	View from Dhurringile Road, Toolamba West looking east showing surrounding agricultural fields	33
Photo 6.12	View Langdon Road, Tatura looking north showing ancillary farming structures and entry gate	33
Photo 7.1	Dhurringile Road existing view	38
Photo 7.2	Toolamba-Rushworth Road existing view	40
Photo 7.3	Toolamba-Rushworth Road existing view	42
Photo 7.4	Dhurringile Road existing view	44
Photo 7.5	Murton Road existing view	46
Photo 7.6	Intersection of Pogue Road and Dhurringile Road existing view	48
Photo 7.7	Toolamba-Rushworth Road existing view	50

Appendices

Appendix A Photomontages

**ADVERTISED
PLAN**

This copied document to be made available for the sole purpose of enabling its consideration and review as part of a planning process under the Planning and Environment Act 1987. The document must not be used for any purpose which may breach any copyright

ADVERTISED PLAN

Terminology

Terminology	Definition
Impact	The effect of a proposal, which can be adverse or beneficial, when measured against an existing condition.
Landscape	All aspects of a tract of land, including landform, vegetation, buildings, villages, towns, cities and infrastructure.
Landscape character	The combined quality of built, natural and cultural aspects which make up an area and provide its unique sense of place.
Landscape character zone	An area of landscape with similar properties or strongly defined spatial qualities, distinct from areas immediately nearby.
Landscape character type	Multiple similar landscape character zones repeated within a larger study area, grouped to avoid repetition in their description.
Landscape and Visual Impact Assessment (LVIA)	A tool used to identify and assess the likely significance of the effects of change resulting from development both on the landscape as an environmental resource in its own right and on people's views and visual amenity.
Magnitude	The measurement of the scale, form and character of a development project when compared to the existing condition. In the case of visual assessment this also relates to how far the project is from the viewer. Combines with sensitivity, magnitude provides a measurement of impact.
Photomontage	A visualisation which superimposes an image of a proposed development upon a photograph or series of photographs.
Project	The construction and operation of the GWV project
Sensitivity	The sensitivity of a landscape character zone or view and its capacity to absorb change of the nature of the proposal. In the case of visual impact this also relates to the type of viewer and number of viewers. Combined with magnitude, sensitivity provides a measurement of impact.
Study area	Consists of land in the vicinity of, and including, the Project site. The study area is a wider area surrounding the project site as defined in this assessment, including land that has the potential to be indirectly impacted by the Project.
Significant	In the context of EIA, after analysing the extent (type, size, scope, intensity and duration) and nature (predictability, resilience of the environment, reversibility, ability to manage/mitigate, level of public interest) of a proposal, an expected level of impact of a proposal project which requires an EIS to be undertaken. The term should be avoided in landscape character and visual impact assessments if the expected level of impacts is below the threshold.
Study area	Consists of land in the vicinity of, and including, the proposed Project site. The study area is a wider area surrounding the proposed Project site as defined in this assessment, including land that has the potential to be indirectly impacted by the Proposal.
Susceptibility	The ability of a defined landscape or visual receptor to accommodate the specific proposed development without undue negative consequences.
Visual amenity	The overall pleasantness of the views people enjoy of their surroundings, which provides an attractive visual setting or backdrop for the enjoyment of activities of the people living, working, recreating, visiting or travelling through an area.
View	The sight or prospect of a landscape or scene.
Viewpoint	The point from which a view is observed that represents a visual receptor.
Visibility	The state or fact of being visible or seen.
Visual impact	The impact on the views from residences, workplaces, and public places.
Visual receptors	Individuals and/or defined groups of people who have the potential to be affected by a proposal.

¹ Partially adapted from: *Environmental impact assessment practice note EIA-N04 - Guideline for landscape character and visual impact assessment, Version 2.2* (Transport for New South Wales, 2020).

Abbreviations

Abbreviations	Definition
3D	Three dimensional
AHD	Australian height datum
CGIA	Central Goulburn irrigation area
DNSP	Distributed Network Service Provider
EES	Environmental Effects Statement
EIS	Environmental Impact Statement
GVW	Goulburn Valley Water
GIS	Geographic Information System
GPS	Global Positioning System
HV	High-voltage
km	Kilometres
LCA	Landscape Character Areas
LEP	Local Environmental Plan
LV	Low voltage
LVIA	Landscape and Visual Impact Assessment
LGA	Local Government Authority
M	Metre
PV	Photovoltaic
PPF	Planning policy framework
RFI	Request for Information
SAT	Single Axis Tracking
WMF	Wastewater Management Facility
VP	Viewpoint

This copied document to be made available for the sole purpose of enabling its consideration and review as part of a planning process under the Planning and Environment Act 1987. The document must not be used for any purpose which may breach any copyright

**ADVERTISED
PLAN**

1. Introduction

The following sections provide an overview of the project, the purpose and scope, and the structure of the report.

1.1 Overview of the project

Goulburn Valley Water (GVW) is seeking to install a large-scale solar facility within its Tatura Wastewater Management Facility (WMF) site. The intent of the solar PV system is to provide GVW with maximum energy yield so that GVW can offset their carbon footprint and generate revenue by selling electricity to the market.

The site is located within GVW owned land and all power generated by the solar facilities will be exported directly to the national electricity transmission network. The proposed solar development system size will be <5MW to meet the targeted annual electricity generation volume.

GHD Pty Ltd (GHD) has been engaged by GVW to undertake a Landscape and Visual Impact Assessment for the proposed solar farm at Dhurringile Road in Tatura, within the Tatura Wastewater Management Facility (WMF) site.

1.2 Purpose and scope of this report

The purpose of this report is to provide a Landscape and Visual Impact Assessment (LVIA) on the Project, including an assessment of the existing landscape and visual context and an assessment of the impacts to the landscape character and visual environment as directed by Clause 53.13 of the Greater Shepparton Scheme for the approval of the planning permit for the use and development of the land for the purposes of a Solar Energy Facility (Renewable Energy Facility).

An application to use and develop land for the purpose of a Solar Energy Facility must be accompanied by a design response that includes accurate visual simulations illustrating the development in the context of the surrounding area and from key public viewpoints.

A Landscape and Visual Impact Assessment (LVIA) is recommended to address the application requirements and decision guidelines provided in Clause 53.13.

This LVIA assesses the landscape character and visual impacts of the proposal, with particular consideration for sensitive landscape and visual receptors, in the area surrounding the proposal. The report comprises the following:

- An understanding of the landscape and visual attributes of the study area
- Identification of sensitivities of landscape and visual receivers in the vicinity of the proposal
- Assessment of potential landscape and visual impacts associated with the proposal
- Provision of recommendations for mitigating or managing any identified landscape and visual impacts arising from the proposal

It is intended that this report accompany a town planning submission by GVW to the Greater Shepparton City Council.

**ADVERTISED
PLAN**

This copied document to be made available for the sole purpose of enabling its consideration and review as part of a planning process under the Planning and Environment Act 1987. The document must not be used for any purpose which may breach any copyright

1.3 Report structure

This report comprises of the following sections:

Section 1 – Introduction: provides background information and an overview of the Project and assessment.

Section 2 – Methodology: describes the methodology used for the purposes of this report.

Section 3 – Project description: describes the proposed development, with emphasis on identifying the key sources of potential impacts relevant to this assessment.

Section 4 – Legislation and policy context: provides a summary of relevant legislation and policy affecting the study area.

Section 5 – Existing landscape and visual context: provides an analysis of the existing landscape character and visual environment of the study area in the context of the Project.

Section 6 – Landscape character assessment: landscape character areas are defined and assessed against the proposed development.

Section 7 – Visual impact assessment: viewshed analysis is described and representative viewpoint locations are identified and assessed.

Section 8 – Cumulative impacts: provides a discussion of potential cumulative impacts.

Section 9 – Mitigation measures and Recommendations: mitigation measures and recommendations are provided in response to issues arising in the assessment of the construction and operation phases of the Project.

Section 10 – Conclusion: presents a summary of the LVIA.

1.4 Limitations

This report: has been prepared by GHD for Goulburn Valley Water and may only be used and relied on by Goulburn Valley Water for the purpose agreed between GHD and Goulburn Valley Water as set out in section 1.2 of this report.

GHD otherwise disclaims responsibility to any person other than Goulburn Valley Water arising in connection with this report. GHD also excludes implied warranties and conditions, to the extent legally permissible.

The services undertaken by GHD in connection with preparing this report were limited to those specifically detailed in the report and are subject to the scope limitations set out in the report.

The opinions, conclusions and any recommendations in this report are based on conditions encountered and information reviewed at the date of preparation of the report. GHD has no responsibility or obligation to update this report to account for events or changes occurring subsequent to the date that the report was prepared.

The opinions, conclusions and any recommendations in this report are based on assumptions made by GHD described in this report (refer section 1.5 of this report). GHD disclaims liability arising from any of the assumptions being incorrect.

Accessibility of documents

If this report is required to be accessible in any other format, this can be provided by GHD upon request and at an additional cost if necessary.

**ADVERTISED
PLAN**

This copied document to be made available for the sole purpose of enabling its consideration and review as part of a planning process under the Planning and Environment Act 1987. The document must not be used for any purpose which may breach any copyright

1.5 Assumptions

This assessment includes the following assumptions and limitations:

- There is no single guidance document on the assessment of landscape and visual impacts specific to Australia, however, the industry typically refers to the guidelines outlined in section 2.1
- The assessment aims to be objective and to describe any potential changes factually. While potential changes resulting from the project are defined, the significance of these changes requires qualitative (subjective) judgements. This assessment's conclusion therefore combines objective measurement and professional interpretation. While this assessment aims to be objective, it is recognised that visual assessment can be subjective, and individuals are likely to associate different visual experiences to the study area.
- The assessment is based on the information provided to GHD at the time of writing
- Existing conditions were assessed in the field on 20th November 2023
- This assessment does not include landscape and visual impacts from lighting

**ADVERTISED
PLAN**

**This copied document to be made available
for the sole purpose of enabling
its consideration and review as
part of a planning process under the
Planning and Environment Act 1987.
The document must not be used for any
purpose which may breach any
copyright**

2. Methodology

The following sections outlines the methodology for this assessment.

2.1 Standards and guidance

The methodology for the LVIA has been set out to respond to specific project requirements and constraints including scale and nature of the project.

There is no general (legislated) guidance on the assessment of landscape and visual effects produced by an independent body specific to Australia. Therefore, the methodology for the LVIA, including impacts, was derived from the *Guidelines for Landscape and Visual Impact Assessment, Third Edition* (The Landscape Institute and the Institute for Environmental Management and Assessment, 2013).

Terminology, assessment methods and nomenclature have also been derived from the following:

- *Solar Energy Facilities - Design and Development Guideline*, (Victoria State Government, Department of Environment, Land, Water and Planning, October 2022)
- *Guidance Note for Landscape and Visual Impact Assessment*, (Australian Institute of Landscape Architects, 2018)

2.2 Study area

Identifying the catchment within which the project may be seen was achieved through a conservative approach in a desktop study that considered the following:

- Aerial photographs
- Topographic maps
- Landform and land cover (screening)
- Potential maximum visibility for this type of development

For LVIA, this becomes the study area, which for this assessment has been set at five kilometres, based upon previous studies of a similar nature and relevant guidelines.

This preliminary visual catchment is then used to identify sensitive receptors with potential views of the project.

**This copied document to be made available
for the sole purpose of enabling
its consideration and review as
part of a planning process under the
Planning and Environment Act 1987.
The document must not be used for any
purpose which may breach any
copyright**

**ADVERTISED
PLAN**

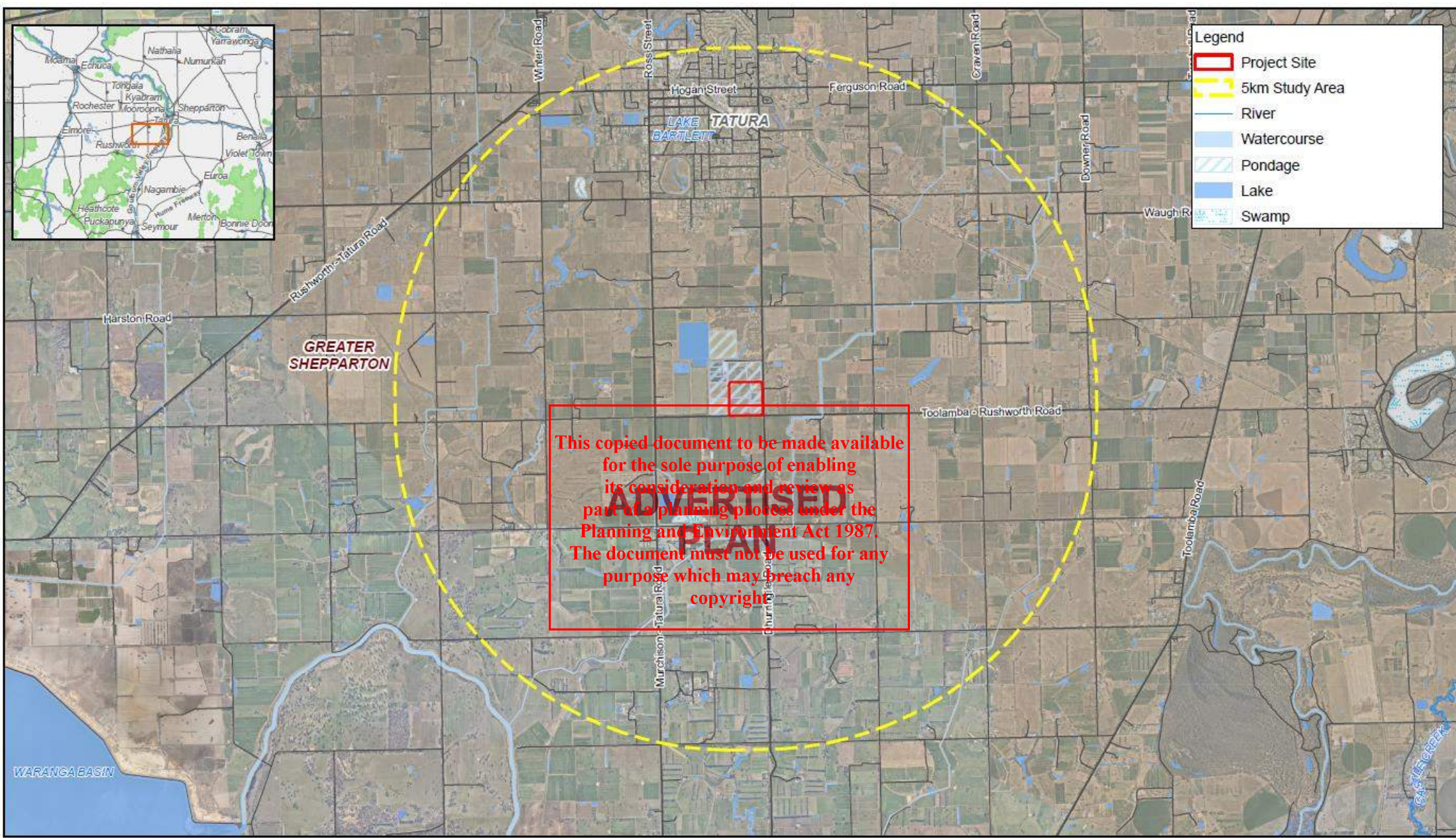

Legend

- Project Site
- 5km Study Area
- River
- Watercourse
- Pondage
- Lake
- Swamp

This copied document to be made available
for the sole purpose of enabling
its consideration and review as
part of a planning process under the
Planning and Environment Act 1987.
The document must not be used for any
purpose which may breach any
copyright.

Figure 2.1 Study Area

Paper Size ISO A4

0 1 2
Kilometers

Map Projection: Transverse Mercator
Horizontal Datum: GDA2020
Grid: GDA2020 MGA Zone 55



Goulburn Valley Water
Goulburn Valley Water Solar Farms

Project No. 12597414
Revision No. A
Date 18/01/2024

Study Area

Figure 2.1

2.3 Legislation and policy context

A review of key planning designations, policies and guidance was undertaken in relation to landscape and visual amenity. The emphasis of the review was to identify designations, protections, values, and objectives relevant to the landscape and visual environment of the study area, including scenic amenity values (refer to section 4).

2.4 Existing landscape and visual environment

2.4.1 Desktop analysis of the project, landscape and visual environment

Existing data was gathered and reviewed, including:

- Project design information
- Topography, land use, and vegetation information
- Google Earth and Google Street View
- Publicly available information of other similar developments within Victoria
- Review of other similar developments within the region

Using this data, a preliminary assessment of the landscape and visual environment was undertaken to inform the site inspection.

2.4.2 Site inspection

A site inspection was undertaken on the 20th of November 2018 with clear visibility and dappled clouds in a blue sky. During the site inspection, the landscape architects drove and walked the study area (refer Figure 2.1) to gain representative views of the project from publicly accessible viewpoints. The purpose of the inspection was to:

- Inspect the study area and appreciate views to and from the project site
- Inspect publicly accessible locations identified in the desktop analysis as likely to provide views of the project
- Identify sensitive visual receptor locations
- Assess the landscape character of the study area and identify landscape sensitivities
- Undertake site photography suitable for photomontage preparation

The coordinates of each viewpoint were recorded during the site inspection. At each location a photographic record of landscape features, key views and receptors was obtained along with field notes and sketches.

2.4.3 Description of existing landscape and visual environment

The description of the existing landscape and visual environment establishes a baseline against which the project is assessed. A landscape existing conditions assessment was undertaken to determine the existing natural and cultural features within the study area. This includes determination of key landscape and spatial elements, features and values. Aspects considered include:

- Land use and built form
- Landform, topography, and hydrology
- Vegetation
- Views
- Historical features

A visual analysis was also undertaken to establish:

- The key views
- Project viewsheds
- Other visual features within the study area

Section 5 outlines the description of the existing landscape and visual environment.

**ADVERTISED
PLAN**

2.5 Landscape impact assessment

2.5.1 Landscape Character Areas

Landscape character considers common landscape types defined by typical features and characteristics identified during the desktop assessment and site inspection. Defining landscape character areas identifies areas sharing the same homogenous environmental or cultural qualities or pattern such as topography, vegetation, hydrology, land use and settlement, built form scale and character, cultural and recreational characteristics.

This approach has been used to establish the existing landscape character around the project site and to provide a framework for measuring the impact of the project. This assists in:

- Defining landscape elements that contribute to defining character
- Defining landscape character attributes
- Identifying landscape value

The assessment of the existing environment also considers factors which have influenced landscape change in the past and those that are likely to do so in the future. The landscape character areas are defined in section 6 .

Landscape value

As part of the existing conditions the value of the landscape is defined for each Landscape Character Area (LCA). The value of the landscape is described in Table 2.1.

When defining landscape character areas, the value attached to the landscape also forms the baseline for which the significance of the impact is measured. Landscape value looks at designated and undesignated landscapes and holistically at all the elements such as the environmental, cultural, historical and visual/sensory elements that form the landscape. The value of the landscape from an international, national, local and community level is considered when applying a landscape value. The following factors are taken into consideration when defining landscape value (Land Use Consultants and Swanwick, C. 2011):

- Landscape quality (physical state of the landscape)
- Scenic quality (appeal of the landscape to the senses)
- Rarity (presence of rare elements)
- Representativeness (distinct character or features of landscape)
- Conservation value
- Recreation value
- Perceptual aspects/qualities
- Associations (with particular people, artists, events in history)

The landscape values for each LCA are described in section 6.

This copied document to be made available for the sole purpose of enabling its consideration and review as part of a planning process under the Planning and Environment Act 1987. The document must not be used for any purpose which may breach any copyright

Table 2.1 Landscape value

Landscape value	Definition
High	Landscape character elements in good or above average condition and/or that make a strong positive contribution to landscape character. May include nationally important features.
Medium	Landscape character elements in reasonably good condition and/or that make an average contribution to the local character, which may include locally important landscape features.
Low	Landscape character elements in below average condition and/or that are not particularly distinctive local features.

**ADVERTISED
PLAN**

2.5.2 Landscape effects

Landscape character refers to a distinct and recognisable pattern of elements that occur consistently in a particular type of landscape. Particular combinations of geology, landform, soils, vegetation, land use and human settlement create character, which makes each part of the landscape distinct and gives each its particular sense of place.

Assessment of landscape effects deals with the effect of change and development on landscape as a resource. The concern is with how the project will affect the elements that make up the landscape, the aesthetic and perceptual aspects of the landscape and its distinctive character. The consideration of potential impacts on landscape character is determined based on the sensitivity of the existing landscape and the magnitude of change that is likely to occur.

The sensitivity of a landscape is judged on the landscape value (refer Table 2.1) and the landscapes susceptibility to change (refer Table 2.2) from a particular type of development. A judgement on the level of sensitivity is made and a rating of high, moderate, or low applied.

The magnitude of change to landscape character depends on the nature, scale and duration of the change expected to occur. The magnitude of change also depends on the loss, change or addition of any feature to the existing landscape. It is based on that part of the landscape character area which is likely to be impacted to the greatest extent by the project.

The sensitivity and magnitude of landscape effects address the following specific criteria:

- Sensitivity of landscape to proposed change, based on the susceptibility to change, and the value of landscape (refer Table 2.2 and Table 2.1 respectively)
- Magnitude of landscape effect, based on the size or scale of change, the geographical extent of effects, and the duration and reversibility of effects (refer Table 2.3)

A judgement is made on the overall level of significance of the landscape effect in relation to the existing conditions.

The assessment criteria have been derived from the *Guidelines for Landscape and Visual Impact Assessment, 3rd Edition* (Landscape Institute and Institute of Environmental Management & Assessment, 2013).

Table 2.2 Landscape susceptibility to change

Landscape susceptibility	Definition
High susceptibility to change	The type of development proposed could have a detrimental effect on the landscape character, condition or value. Mitigation measures are unlikely to reduce the impacts of the change.
Moderate susceptibility to change	Any change caused by the type of development would be unlikely to have a significant adverse effect on the landscape character, condition or value that could not be mitigated.
Low susceptibility to change	Development of this type is unlikely to have an adverse effect on the landscape character, condition or value. Mitigation measures would be effective in neutralising adverse effects.

**ADVERTISED
PLAN**

This copied document to be made available for the sole purpose of enabling its consideration and review as part of a planning process under the Planning and Environment Act 1987. The document must not be used for any purpose which may breach any copyright

Table 2.3 Magnitude of change criteria (landscape)

Rating	Criteria
High	A substantial/obvious change to the landscape character due to total loss of, or change to, elements, features or characteristics of the landscape. Would cause a landscape to be permanently changed and its quality diminished.
Moderate	Discernible changes in the landscape character due to partial loss of, or change to elements, features or characteristics of the landscape, however, has potential to be partly mitigated. The change would be out of scale with the landscape character, and at odds with the local pattern and landform and would leave an adverse impact on the landscape character.
Low	Minor loss or alteration to one or more key landscape character elements, features or characteristics, or the introduction of components that may be new but may not be uncharacteristic within the existing landscape character.
Negligible	Almost imperceptible or no change in the landscape character as there is little or no loss of/or change to the elements, features, or characteristics of the landscape.

2.6 Visual impact assessment

2.6.1 Viewpoint selection

Assessment of visual impacts deals with the effects of change and development on the views available to people and their visual amenity. It assesses how the surroundings of individuals or groups of people may be specifically affected by changes in the context and character of views as a result of the change or loss of existing elements of the landscape and/or the introduction of new elements.

Visual receptors have been considered in terms of the views they are likely to obtain from within the study area including consideration of any key vantage points, such as lookouts, where there is particular interest in the view. Visual receptors are identified based on:

- Proximity of the receptors to the project, as the most affected visual receptors are anticipated to be located closest to the project, unless located at an elevated vantage point
- Type of receptor, as different viewer types would have different perceptions of the change

Based on the analysis of the existing landscape and visual environment, sensitive visual receptors were identified, and viewpoint locations selected as representative locations for assessment. Viewpoints are selected in order to:

- Represent views of particular landscape and/or visual features of importance
- Represent fixed or transient views
- Represent views from public viewpoints (including open land, buildings, public footpaths)
- Represent views from transport routes from private vehicles and public transport
- Represent views from where people work and spend extended amounts of time
- Represent views from recreational receptors such as (parks, tourist areas)
- Represent views from residential receptors

The views available from each viewpoint were photographed and the existing conditions were described using the following information in order to establish the visual existing conditions:

- Location
- Landform/significant features
- Vegetation
- Water
- Land use, infrastructure, built form
- Visual context

Refer to section 2.4 for existing conditions and section 7.1 for the viewpoint locations.

This copied document to be made available for the sole purpose of enabling its consideration and review as part of a planning process under the Planning and Environment Act 1987. The document must not be used for any purpose which may breach any copyright.

ADVERTISED
PLAN

2.6.2 Visual effects

The evaluation of potential impacts on the visual environment is based on the sensitivity of the viewpoint (and the visual receptor it represents) to change, and the magnitude of change that is likely to occur.

The sensitivity of each viewpoint is considered to be dependent on the:

- Importance of the view, its existing scenic qualities and the presence of other existing human-made elements in the view
- Type of visual receptor and their likely interest in the view
- The visual receptors viewing duration and opportunity (i.e., prolonged and regular viewing opportunities versus short-term and transient viewing opportunities)

The magnitude of change to views and the visual environment depends on the nature, scale and duration of the change that is expected to occur. The magnitude of a change also depends on the loss, change or addition of any feature in the field of view of the receptor including an assessment of the level to which the change contrasts with the existing view or expected view of the landscape. This includes the degree of any change to the backdrop to, or outlook from a viewpoint.

The assessment considers the likely impacts of the project. The level of effects on a view depends on factors such as the extent of visibility, degree of obstruction of existing features, degree of contrast with the existing view, angle of view, duration of view and distance from the project.

Steps undertaken to assess visual effects include:

- Identify and map viewpoint locations
- Undertake assessment of visual effects, comprising:
 - Sensitivity of visual receptors to change, based on:
 - Susceptibility of visual receptors to change, and value attached to views (refer Table 2.4)
 - Magnitude of visual effect, based on:
 - Size or scale of change; geographical extent of effects; and duration and reversibility of effects (refer Table 2.5)

An assessment is undertaken of the overall level or significance of the visual effects in relation to the existing view.

Table 2.4 Sensitivity to change criteria (visual)

Rating	Criteria
High	Occupiers of residential properties, at home or going to or from, with long viewing periods, within proximity to the proposed development; Communities that place value upon the landscape and enjoyment of views of their setting.
Moderate	Outdoor workers who have a key focus on their work who may also have intermittent views of the study area; Viewers at schools, or similar, when outdoor play and recreation areas are located within close proximity but viewing periods are limited; Occupiers of residential properties with long viewing periods, at a distance from or screened from the study area.
Low	Road users in motor vehicles, trains or on transport routes that are passing through or adjacent to the study area and therefore have short term views; Viewers indoor at their place of work, schools or similar.
Negligible	Viewers from locations where there is screening by vegetation or structures where only occasional screened views are available and viewing times are short; Road users in motor vehicles, trains or on transport routes that are passing through/adjacent to the study area and have partially screened views and short viewing times.

This report does not change based on available information for the sole purpose of enabling its consideration and review as part of a planning process under the Planning and Environment Act 2001. The document must not be used for any purpose which may breach any copyright.

ADVERTISED
PLAN

ADVERTISED PLAN

Table 2.5 Magnitude of change criteria (visual)

Rating	Criteria
High	A substantial/obvious change to the existing view due to total loss of, or change to, elements, features or characteristics of the view. Would cause a view to be permanently changed and its quality diminished.
Moderate	Discernible changes in the existing view due to partial loss of, or change to elements, features or characteristics of the view, however, has potential to be partly mitigated. The change would be out of scale with the existing view and would leave an adverse impact on the view.
Low	Minor loss or alteration to one or more key view elements, features or characteristics, or the introduction of components that may be visible but may not be uncharacteristic within the existing view.
Negligible	Almost imperceptible or no change in the view as there is little or no loss of/or change to the elements, features or characteristics of the view.

2.7 Significance of impact

The combination of sensitivity and magnitude determines the significance of the impact on the landscape character or representative viewpoint. Refer to Table 2.6 for the matrix used to determine the significance of impact.

Table 2.6 Significance of impact matrix (landscape and visual)

		Magnitude of impact			Negligible
		High	Moderate	Low	
Sensitivity	High	High	High-moderate	Moderate	Negligible
	Moderate	High-moderate	Moderate	Moderate-low	Negligible
	Low	Moderate	Moderate-low	Low	Negligible
	Negligible	Negligible	Negligible	Negligible	Negligible

This copied document to be made available for the sole purpose of enabling its consideration and review as part of a planning process under the Planning and Environment Act 1987. The document must not be used for any purpose which may breach any copyright

2.8 Panorama and photomontages

All photographic images were captured using a 50 mm fixed focal length lens on a 35 mm full frame format camera at a camera height of 1.7 m, as recommended in the IEMA guidelines (IEMA, 2002) All photograph locations were recorded and mapped.

A series of seven viewpoint locations were chosen and the existing views represented at these viewpoints using a panorama technique. This technique involves the stitching together of a number of adjoining images using the Adobe Photoshop software program. All images are represented with an 80-degree horizontal field of view and an 18-degree vertical field of view.

Of the seven viewpoint locations, three viewpoints were selected for the production of photomontage images to represent proposed views following the completion of the project. The software used to model and render the photomontages was Autodesk 3D Studio Max. In order to achieve an accurate photomontage of the project and surrounding landscape, a digital terrain model with a 10 metre contour interval was used to model the surrounding landform.

Once the 3D model incorporating both the landscape and new project elements was created, a virtual camera was placed in the software at the same location the photographs were taken. The focal lens and height of the virtual camera matches the real camera utilised to take the photographs. The photographs of the site were used in 3D Studio Max as a background to accurately match the 3D model with the project elements to the perspective of the

ADVERTISED PLAN

photographs. From the camera view, rendered images of the project were produced to match the daylight exposure of the photographs. The rendered images were imported into Adobe Photoshop for post-production editing and collation of the photomontages.

The result is the 3D model of the project shown in the correct 3D location in the photographs. The final images were produced to a high resolution, suitable for printing. Refer to Appendix A for photomontages of the project.

Site photography, panorama and photomontage were prepared with reference to the following guidance:

- *Visual Representation of Development Proposals, Technical Guidance Note 06/19* (Landscape Institute, 2019)

In addition, a redline overlay has been incorporated to illustrate the project's location within the landscape. This overlay is strategically employed in cases where views may be obscured by topography, vegetation, or the position of the viewpoint, providing an understanding of the project's integration into the surrounding landscape.

2.9 Cumulative impacts

A cumulative impact assessment was undertaken to assess the impact of the project as a result of additional changes to the landscape or visual environment in conjunction with other developments, or actions that are existing, planned or approved.

Cumulative effects can be described as the additional changes caused by a proposed development in conjunction with other similar developments or as the combined effect of a set of developments, taken together (Scottish National Heritage, 2012).

The primary concern is whether or not the proposal, together with other developments in the area intensifies the landscape and/or visual impacts more so than the sum of each individual development. The emphasis remains on the main project being assessed and whether it adds to or combines with the other development to create a significant cumulative effect.

2.9.1 Study area for cumulative impact assessment

A study area of five km was used to consider cumulative impacts of existing, planned and approved in accordance with the scoping requirement.

2.9.2 Criteria definition

The following sections describe the criteria that have been used to assess the cumulative landscape and visual impact of the project against each individual development identified within the cumulative impact study area. The individual assessments were then used to produce a summary of cumulative landscape and visual impact for the project.

Similarity to project in scale and form

The similarity of the project to other projects identified in terms of scale and form would affect the overall cumulative impact.

The following classifications have been applied to these criteria:

- **High** – Both projects are very similar in scale and form and may read as one development
- **Moderate** – Both projects are moderately similar in scale and form
- **Low** – Both projects are very different in terms of scale and form
- **Negligible** – Both projects are incomparable in scale and form

Timing of development

The effect of many projects being implemented within a similar timescale or concurrently would have a significant cumulative impact. This would create a sense of the landscape undergoing a process of rapid development. The inverse would be a scenario where development takes place one project at a time over an extended period, such

This copied document to be made available for the sole purpose of enabling its consideration and review as part of a planning process under the Planning and Environment Act 1987. The inclusion of cumulative impacts of existing purpose which may breach any copyright

that the change in landscape character would virtually go unnoticeable and not beyond what would be normally expected.

Developments that are at the pre-planning or scoping stage have not generally been considered in the assessment of cumulative effects because firm information on which to base the assessment is not available and the associated uncertainty about what would actually occur. Developments with planning consent or a valid planning application have been considered as the likelihood of implementation is high.

The following classifications have been applied to these criteria:

- **High** – It is highly likely that both projects would be implemented concurrently or have overlapping construction programs
- **Moderate** – There is a reasonable possibility that both projects may be implemented within a similar or overlapping timescale
- **Low** – Both projects are not likely to be implemented within a similar or overlapping timescale
- **Negligible** – There is no possibility for both projects to be implemented within a similar or overlapping timescale

Likelihood of combined visibility

The ability to view two or more developments from the same viewing location would result in a greater cumulative impact than where only one development is visible from a given location. Furthermore, being able to see two or more developments while looking in one direction would have a greater cumulative impact than if a viewer has to turn to look in different directions to see all of the developments.

Assumptions have been made about the appearance of the various proposed or approved developments without the aid of visual materials.

The following classifications have been applied to these criteria:

- **High** – Both developments would be clearly visible together in views from one direction from a given location and/or could possibly be interpreted as part of the same development
- **Moderate** – There is a reasonable possibility of being able to see both developments by turning to look in different directions, but not while looking in the same direction
- **Low** – It is unlikely that both developments would be visible from the same viewing location, either while looking in one direction or having to turn to look in different directions
- **Negligible** – It is not possible for both developments to be visible from the same viewing location

Likelihood of sequential visibility

Sequential visibility refers to the ability to view two or more developments in succession whilst moving along a linear route such as a road, track or pathway.

The following are types of sequential views that may be experienced:

- Frequently sequential: where two or more developments appear regularly and within short time lapses between instances as the viewer is moving quickly or the distance between the viewpoints is short
- Occasionally sequential: where longer time lapses between views of two or more developments occur as the viewer is moving slowly and/or there are larger distances between the viewpoints
- Rarely sequential: the time lapses between views of two or more developments are so great that the developments would seem completely disconnected

The following classifications have been applied to these criteria:

- **High** – Views of both developments would be frequently sequential
- **Moderate** – Views of both developments would be occasionally sequential
- **Low** – Views of both developments would be rarely sequential
- **Negligible** – Sequential views of both developments would not be possible

**ADVERTISED
PLAN**

2.10 Mitigation measures and recommendations

Mitigation measures and recommendations were developed that respond to and reduce and minimise the impacts identified within the assessment (refer section 9).

Potential mitigation measures may include:

- Adopting alternative designs or revisions to the basic engineering and architectural design to prevent and/or minimise negative impacts
- Remedial measures such as colour and textural treatment of structural features
- Compensatory measures such as landscape design to compensate for unavoidable negative impacts and to attempt to generate long-term positive impacts

2.11 Response to key legislation and policy

The project was reviewed against the key legislation and policy identified in section 4 and an overview of how the project responds to the key legislation and policy provided.

2.12 Stakeholder engagement

Stakeholders, including the community, Yorta Yorta RAPs, and the adjacent landholders, were consulted to support the preparation of the project planning process and inform the project's development and understanding of potential impacts.

2.13 Assumptions and limitations

This assessment includes the following assumptions and limitations:

- There is no single guidance document on the assessment of landscape and visual impacts specific to Australia, however, the industry typically refers to the guidelines outlined in section 2.1
- The assessment aims to be objective and to describe any potential changes factually. While potential changes resulting from the project are defined, the significance of these changes requires qualitative (subjective) judgements. This assessment's conclusion therefore combines objective measurement and professional interpretation. While this assessment aims to be objective, it is recognised that visual assessment can be subjective, and individuals are likely to associate different visual experiences to the study area.
- The assessment is based on the information provided to GHD at the time of writing
- Existing conditions were assessed in the field on 20th of November 2023

**ADVERTISED
PLAN**

This copied document to be made available for the sole purpose of enabling its consideration and review as part of a planning process under the Planning and Environment Act 1987. The document must not be used for any purpose which may breach any copyright

3. Project description

The following section provides a summary of the project and includes the detail relating to the main visual components that have potential to affect the landscape character and visual amenity of the study area.

3.1 The project site

The project is located in Tatura within the Goulburn Valley region in the Shire of Greater Shepparton (refer to Figure 3.1), about 150 km north of Melbourne. The region supports various agricultural activities, including cultivation of fruits and vegetables, dairy farming and food processing industries.

The project site would be located on GVW owned land, south of the existing Wastewater Management Facilities (WMF). The project site is bounded by Dhurringile Road to the east and Toolamba-Rushworth Road to the south. The solar site is a decommissioned drying pan, which was previously used as part of the wastewater treatment process.

The nearest rural residential dwelling is located on Dhurringile Rd, approximately 300 m east of the project site.

ADVERTISED PLAN

**This copied document to be made available
for the sole purpose of enabling
its consideration and review as
part of a planning process under the
Planning and Environment Act 1987.
The document must not be used for any
purpose which may breach any
copyright**

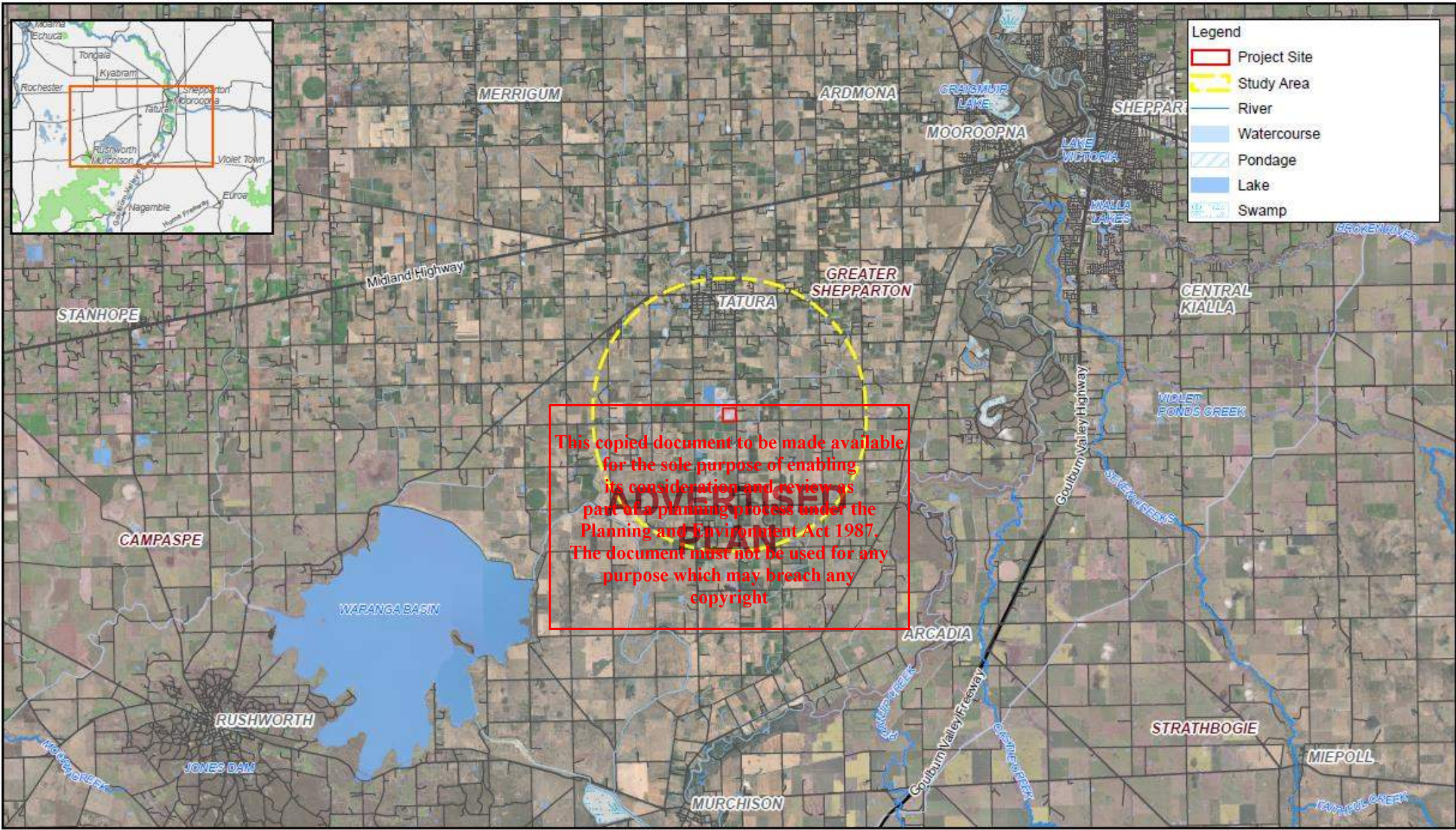

Figure 3.1 Project location plan



Goulburn Valley Water
Goulburn Valley Water Solar Farms

Project No. 12597414
Revision No. A
Date 07/12/2023

Project location plan

Figure 3.1

ADVERTISED PLAN

3.2 Project overview

GVW is seeking to install a large-scale solar facility in Tatura GVW WMF site. The site is located within GVW owned land and all power generated by the solar facilities will be exported directly to the national electricity transmission network.

The ground mounted solar Photovoltaic (PV) generating systems and associated grid connection infrastructure are to be located on GVW owned land located adjacent to Wastewater Management Facilities (WMF) at Tatura.

The project will include a large scale solar photovoltaic (PV) generation plant, high voltage (HV) infrastructure integration and reticulation systems comprising of the following:

- Fixed tilt or Single Axis Tracking (SAT) PV arrays located within GVW land as shown in Figure 3.2
- Power stations comprising of inverters, transformers, ring main units, controls, communication systems, AC/DC reticulation and other balance of plant
- Control and switching room building
- Associated civil and structural works at the Solar Farm
- Integration into the DNSP electrical network including HV cabling (above and underground), conduits, pits (a substantial portion of this being in GVW land)
- Meteorological station
- Access roads and pavement
- Landscaping
- Security fencing at all perimeter boundaries to restrict access

This copied document to be made available for the sole purpose of enabling its consideration and review as part of a planning process under the Planning and Environment Act 1987. The document must not be used for any purpose which may breach any copyright

3.2.1 Construction phase

Construction activities are expected to include:

- Site preparation and establishment of temporary ancillary construction infrastructure including:
 - Fencing
 - Site office and amenities
- Removal of topsoil, softened or loose material, material that does not meet required bearing pressure requirements, grassroots or other organic matter, rubble, debris, and all unsuitable material below foundations and roads
- Stockpile suitable topsoil for re-use to 1500 mm maximum height
- Construction of foundations including slabs on ground, slabs/footings of the substations and external slabs on ground supporting electrical and other equipment
- Construction of steel structures for PV module supporting structures and any other required ancillary structures or site access specifics
- Construction of pavement areas for car park, hardstand and access roads
- Construction of storage areas
- Temporary and permanent sediment and erosion control measures

Construction and delivery timeframes will be subject to the contractors responsible for the detailed design and construction and ongoing operation and maintenance of the facility. With construction to be undertaken during an approximate duration of seven to nine months. Use of the site for temporary works and construction plant, including working and storage areas, location of offices, workshops, sheds, roads and parking are restricted to areas approved by GVW.

3.2.2 Operation phase

During operation the maintenance of diverse elements such as PV modules, combiner boxes, inverters, low-voltage panels, security systems, meteorological stations, and other critical components will be undertaken. The frequency of inspections and tasks ranges from daily to yearly, encompassing visual checks, electrical parameter

controls, thermography inspections, and specific tests to ensure optimal performance, safety, and longevity of the solar infrastructure.

Electrical and Solar (Operation and Maintenance)

Operation and maintenance include, but not limited to, PV modules, power conversion units, cabling (DC and AC), combiner boxes, MV switchgear, protection relays, auxiliary supply transformers, alarm and fire systems, UPS, battery backup, mechanical systems, earthing and bonding, SCADA, remote monitoring, LV metering, and meteorological stations.

Civil/Structural (Operation and Maintenance)

Operation and maintenance include, but not limited to, PV mounting structures, access roads, fences, gates, hardstands, foundations, structural supports, drainage, sediment and erosion control, vegetation management, wildlife prevention, and tank maintenance (including ensuring adequate filling)

3.2.3 Buildings and above ground infrastructure

Buildings would be of metal clad demountable buildings, with a maximum height of 5.4 m. Buildings would also be set back a minimum of 30 m from the adjacent roads.

Table 3.1 Key proposed buildings and above ground infrastructure

Type	Height
PV modules, and solar tracker	Less than 2.60 m (approximately)
Admin building	5.40 m (approximately)
Ancillary infrastructure including switch room, and auxiliary supply transformers.	Less than 2.0 m (approximately)
Fence and gate	1.20 m (approximately)

3.2.4 Access roads and pavements

Primary and secondary access road entrances are located on Toolamba-Rushworth Road. Road widths, including three internal roads, are set at approximately six metres, unsealed, and composed of cement-treated crushed rock at a minimum of 200 mm deep. Pavements which have minimum loading for light passenger vehicles and infrequent trafficking by heavy vehicles, including access tracks and hardstand areas are constructed from a mix of crushed rock and cement.

This copied document to be made available for the sole purpose of enabling its consideration and review as part of a planning process under the Planning and Environment Act 1987. The document must not be used for any purpose which may breach any copyright

ADVERTISED PLAN

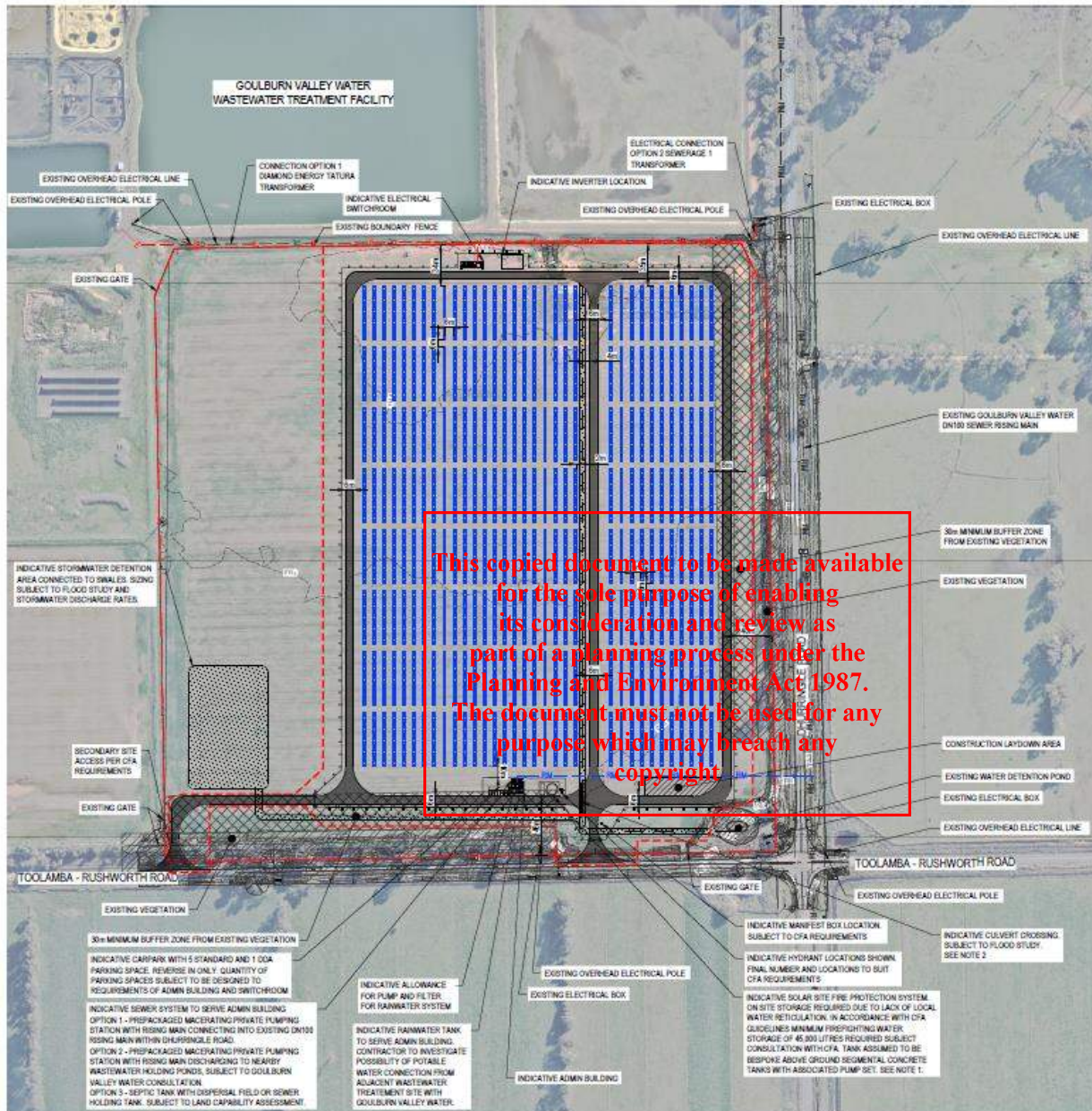

LEGEND

	SITE BOUNDARY (AREA = 245,745 m ²)
	EXTENT OF WORKS / PROJECT AREA (AREA = 170,560 m ²)
	30m VEGETATION BUFFER ZONE
	EXISTING POND
	EXISTING VEGETATION
	EXISTING FENCE
	EXISTING MAJOR CONTOURS
	EXISTING MINOR CONTOURS
	EXISTING OVERHEAD ELECTRICAL POST
	EXISTING GATE
	PROPOSED GATE
	PROPOSED FENCE
	INDICATIVE SOLAR PANEL
	INDICATIVE INVERTER
	PROPOSED SWALE
	PROPOSED HYDRANT
	PROPOSED UNSEALED ROADS
	PROPOSED ELECTRICAL LINES
	PROPOSED SEWER RISING MAIN
	EXISTING OVERHEAD ELECTRICITY
	EXISTING SEWER RISING MAIN

- NOTES:**
1. REFERENCE CFA GUIDELINES 'DESIGN GUIDELINES AND MODEL REQUIREMENTS - RENEWABLE ENERGY FACILITIES V4.
 2. CONTRACTOR TO INCLUDE CULVERTS FOR 10% AEP FOR DRAIN CROSSINGS.

Figure 3.2 Proposed site layout plan

PLAN
SCALE 1:2000

**ADVERTISED
PLAN**

PRO CONCEPT DESIGN	M.G.	A.V.	18/10/23
P01 DRAFT CONCEPT DESIGN	M.G.	A.V.	18/10/23
Rev Description	Checked	Approved	Date
Author M. PAIRA	Drafting Check D. KOROTOWIC		
Designer M. JARING	Design Check M. GOODE		

0 20 40 60 80 100m
SCALE 1:2000 AT ORIGINAL SIZE

File Name: C:\12579414\GHD-00-00-DRG-CI-00100.dwg

GHD Level 2, 150 Lonsdale Street, Melbourne VIC 3000 Australia
T 61 3 9667 8000 F 61 3 9667 8111
E enquiries@ghd.com W www.ghd.com

Conditions of Use: This document may only be used by GHD client and any other person who has agreed in writing to this document for the purpose for which it was prepared and may not be used for any other purpose in any other project.

Client GOULBURN VALLEY WATER
Project GWV SOLAR FARM
Status IN DEVELOPMENT

Project No. 12579414

Drawn By TATURA
Title SITE LAYOUT PLAN

12579414-GHD-00-00-DRG-CI-00100

Rev A1
Rev P02

ADVERTISED PLAN

4. Legislation and policy context

A detailed review of government policies was undertaken to inform and identify key objectives for the landscape and visual impact assessment.

This is not intended to be a thorough review of the planning scheme, mechanisms and planning related triggers. The emphasis of the review was to identify designations, protections, values, and objectives relevant to the landscape and visual environment of the study area, including scenic amenity values.

4.1 State legislation and policy

4.1.1 Planning and Environment Act 1987

The Planning and Environment Act 1987 serves as foundational legislation, establishing the legal structure for Victoria's planning system. It facilitates the creation of the Victoria Planning Provisions and local planning schemes. Additionally, it sets forth procedures for various aspects, including:

- Obtaining planning permits under planning schemes
- Compensating for land required for public purposes
- Handling state-significant projects

4.1.2 Victorian Planning Policy Framework (PPF)

The provisions and respective objectives of the Victorian Planning Policy Framework (PPF) discussed in this section are considered relevant to the study area and prepared recommendations. The PPF seeks to ensure that the objectives of planning in Victoria (as set out in Section 4 of the *Planning and Environment Act 1987*) are fostered through appropriate land use and development planning policies and practices which integrate relevant environmental, social, and economic factors in the interests of net community benefit and sustainable development.

The following provisions and associated objectives of the PPF are relevant to the study area.

Clause 12.05-2S Landscapes

The objective of 12.05-2S is *To protect and enhance significant landscapes and open spaces that contribute to character, identity and sustainable environments.*

The relevant strategies of this Clause relating to visual amenity, character and environment include:

- *To protect and enhance significant landscapes and open spaces that contribute to character, identity and sustainable environments*
- *Ensure development does not detract from the natural qualities of significant landscape areas*
- *Improve the landscape qualities, open space linkages and environmental performance in significant landscapes and open spaces, including green wedges, conservation areas and non-urban areas*
- *Recognise the natural landscape for its aesthetic value and as a fully functioning system*
- *Ensure important natural features are protected and enhanced*

Clause 19.01-2S Renewable energy

The objective of 19.0-2S is *to support the provision and use of renewable energy in a manner that ensures appropriate siting and design considerations are met.*

The relevant strategies of this clause is to:

- Facilitate renewable energy development in appropriate locations
- Protect renewable energy infrastructure against competing and incompatible uses

- Set aside suitable land for future renewable energy infrastructure
- Consider the economic, social and environmental benefits to the broader community of renewable energy generation while also considering the need to minimise the effects of a project on the local community and environment

4.2 Local legislation, policy, and guiding documents

The study area is subject to the provisions of the Greater Shepparton Planning Scheme (the 'planning scheme').

4.2.1 Local Planning Policy Framework – Greater Shepparton Planning Scheme

As the project site falls within the Greater Shepparton Planning Scheme, the Council's objectives concerning land use, development, and land protection are articulated through adherence to the Local Planning Policy Framework. The project will be evaluated against the following landscape and visual environment criteria.

4.2.1.1 Zoning and overlays

The entirety of the proposed project falls within the PUZ1 - Public use and service and utility as defined in the Planning Scheme. Solar farm facilities are deemed permissible, contingent on the renewable energy project meeting the stipulations outlined in Clause 53.13 about Renewable Energy Facilities (Other than Wind Energy Facilities).

Clause 53.13 Renewable energy facility (other than wind energy facility and geothermal energy extraction)

The objective of 53.13 To facilitate the establishment and expansion of renewable energy facilities, in appropriate locations, with minimal impact on the amenity of the area.

The relevant strategies of this clause:

- Accurate visual simulations illustrating the development in the context of the surrounding area and from key public viewpoints
- The impact of the project on significant views, including visual corridors and sightlines

The study area comprises defined zones, each with specific objectives relating to the landscape and visual environment. The overlays are positioned on all axis of the site within the study area and connected to the Goulburn River tributaries. These associations encompass:

LSIO – Land Subject to Inundation

- To ensure that development maintains the free passage and temporary storage of floodwaters, minimises flood damage, responds to the flood hazard and local drainage conditions and will not cause any significant rise in flood level or flow velocity
- To minimise the potential flood risk to life, health and safety associated with development

This overlay extends across the northeastern quadrant of the land, including a small portion of the project site located at the northeast corner along Dhurringile Road.

FO – Floodway Overlay

- To identify waterways, major flood paths, drainage depressions, and high-hazard areas within urban areas with the most significant risk and frequency of flooding
- To ensure that any development maintains the free passage and temporary storage of floodwater minimises flood damage and is compatible with flood hazards, local drainage conditions and the minimisation of soil erosion, sedimentation, and silting

This overlay extends along the far western boundary of Murchison Tatura Road, however, does not encompass the project site.

**ADVERTISED
PLAN**

4.3 Other relevant policy

4.3.1 Greater Shepparton 2030 strategy

The City of Greater Shepparton, in collaboration with the Department of Sustainability and Environment, has devised 'Greater Shepparton 2030,' a blueprint to foster sustainable economic activity and enhance the quality of life in the municipality for the next 30 years. Embedded within the Greater Shepparton 2030 strategy are specific objectives and actions related to renewable energy development, outlined through various targets.

Objective Four of the Best Practice Land Management articulates the goal of reducing greenhouse gas emissions through local initiatives, with a commitment to the well-being of both current and future generations. The strategy explicitly supports the aspiration to decrease community greenhouse gas emissions from 1999 levels by 20% before 2010.

**ADVERTISED
PLAN**

**This copied document to be made available
for the sole purpose of enabling
its consideration and review as
part of a planning process under the
Planning and Environment Act 1987.
The document must not be used for any
purpose which may breach any
copyright**

5. Existing landscape and visual environment

The following section provides a summary of the existing landscape and visual environment of the study area.

5.1 Land use and built form

The study area is located four kilometres south of the township of Tatura, Victoria, approximately 180 km northwest of Melbourne. The Project site is in the Greater Shepparton LGA. Farming Zone (FZ1) is the predominant land use zoning surrounding the Project site, with the project site marked as Public Use Service and Utility (PUZ1). The Project site encompasses the existing GVW Wastewater Management Facilities (WMF) which currently provides treatment of wastewater to be reused for irrigation for growing timber and crops.

The existing farmland surrounding the Project site typically has a sense of openness and vastness on slightly undulating topography with scattered trees and farming buildings. Being situated on large allotments, dwellings are widely dispersed. The vegetated road verges and paddock buffers restrict and partially filter views across the study area and towards the Project site.

The project site is situated within the boundaries of Pogue Road to the north, Toolamba Rushworth Road to the south, Murchison Tatura Road to the west, and Dhurringile Road to the east. Murchison-Tatura Rd and Rushworth- Tatura Rd provide crucial regional connection.

The township of Tatura is characterised by a predominance of one and two-storey dwellings, contributing to the residential character. The regional town is a major employer within the Goulburn Valley and offers different amenities including schools, health care facilities, local businesses, and recreational amenities (Greater Shepparton City Council, 2021).

5.2 Topography and hydrology

The Project site and surrounding topography is characterised by a highly modified, gridded, low-lying and relatively flat landscape with gentle slopes towards a network of irrigation channels. The landscape is characterised by a field-pattern of one mile (1.6 km) wide blocks, with a gridded network of smaller irrigated agrarian paddocks, supporting diverse farming industries, with highly modified canals and channels on the periphery. The topography varies in elevation from approximately 100 m to 180 m above sea level.

Stretching westward from the townships of Tatura and Mooropna, the Central Goulburn Irrigation Area (CGIA) defines the agricultural landscape of Northern Victoria.

The Goulburn River and its tributaries shape the wider region's hydrology. Often harnessed for irrigation, the river's water supports the cultivation of crops in the fertile plains encircling the project site and the broader landscape. The Waranga Basin Reservoir is located approximately ten kilometres southwest of the project site.

5.3 Vegetation

The study area sits within the Victorian Riverina Bioregion and has been historically cleared and disturbed for settlement, grazing, cropping and recreation since European settlement. Cropping and pastoral fields weave a tapestry of regularity and uniformity, creating the distinctive characteristics of operations inherent to agricultural production. Land cover further shapes the landscape, featuring scattered and denser tree cover along road corridors and field boundaries.

While much of the original native vegetation in the Goulburn Valley has been cleared due to the demands of agriculture, remnants persist in select areas along the river corridors and patches of native bushland.

**ADVERTISED
PLAN**

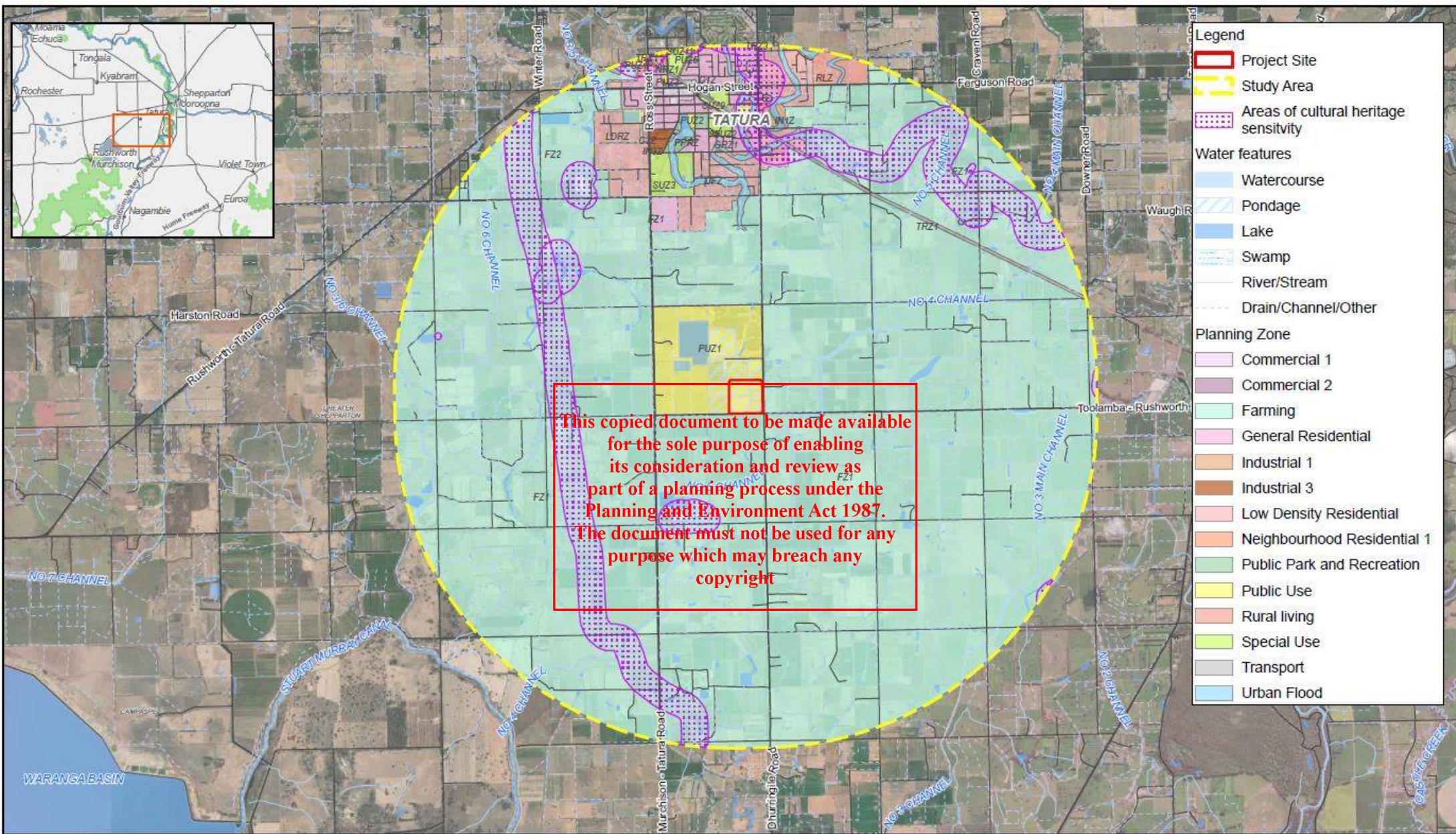

Figure 5.1 Land use and built form

**ADVERTISED
PLAN**



Goulburn Valley Water
Goulburn Valley Water Solar Farms

Project No. 12597414
Revision No. A
Date 07/12/2023

Land use and built form

Figure 5.1

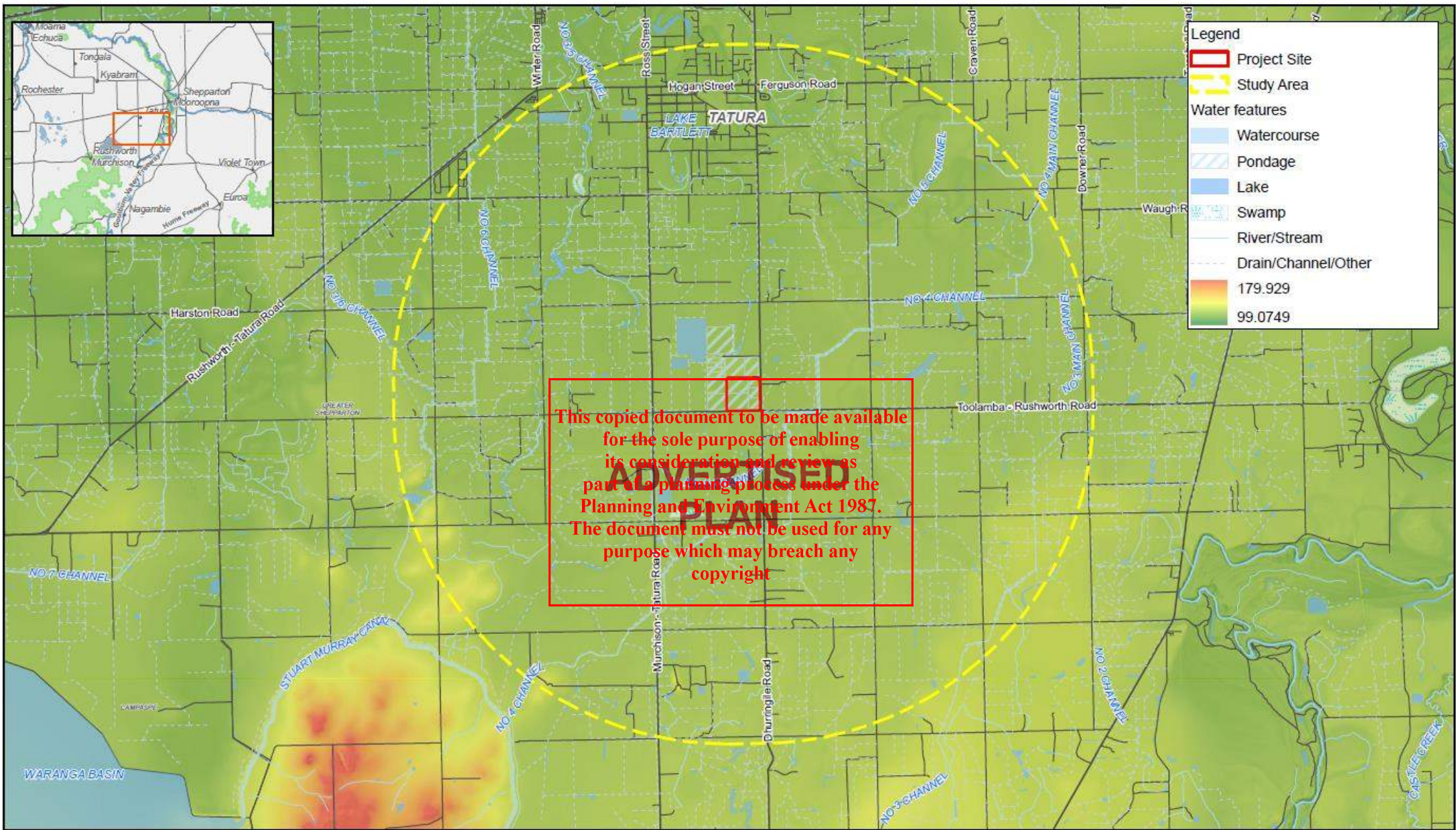
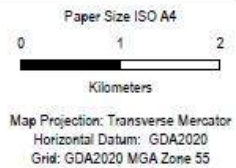

Figure 5.2 Topography and hydrology



Goulburn Valley Water
Goulburn Valley Water Solar Farms

Project No. 12597414
Revision No. A
Date 07/12/2023

Topography and hydrology

Figure 5.2

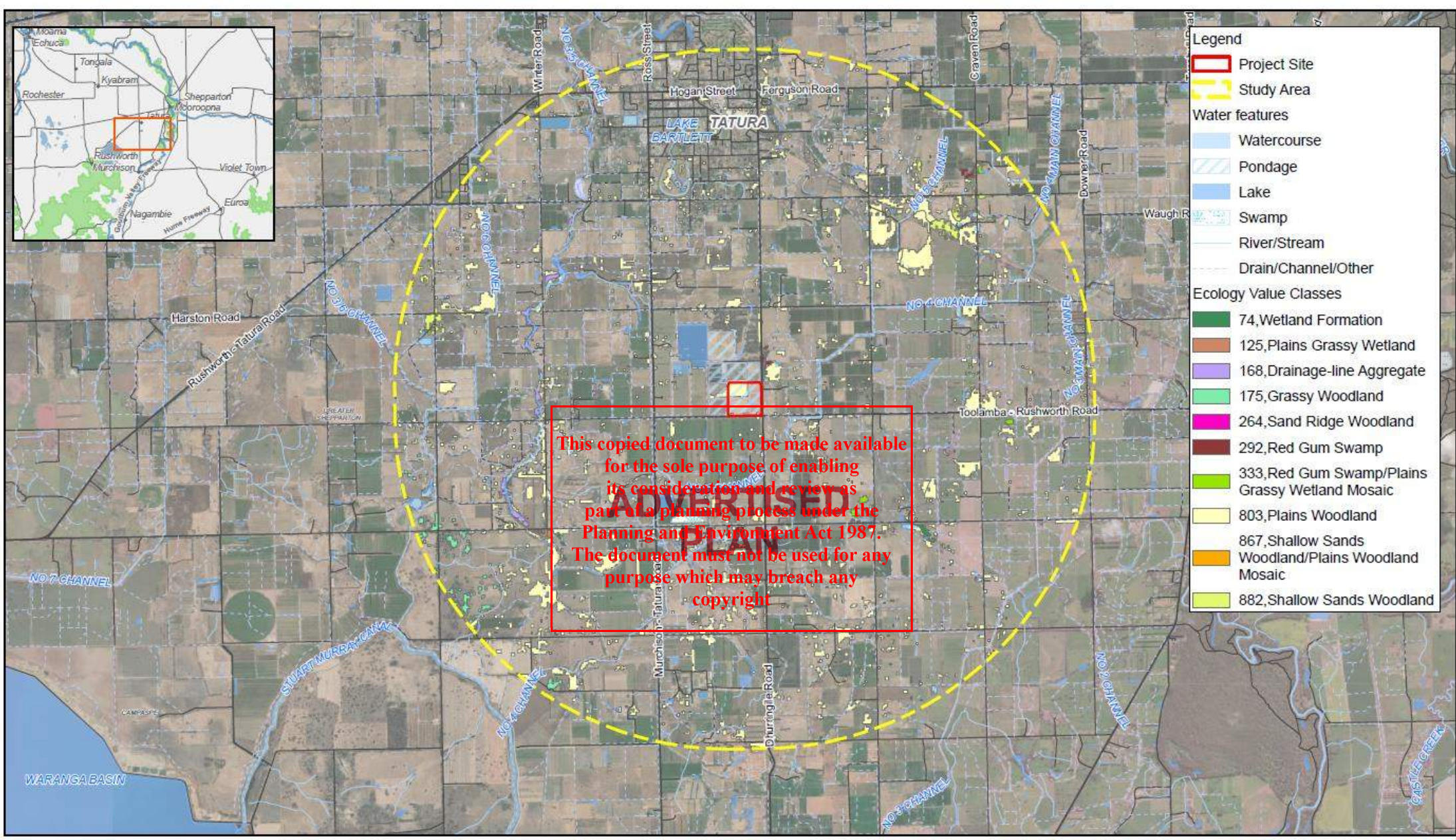
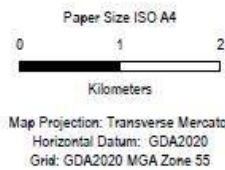

Figure 5.3 Vegetation



Goulburn Valley Water
Goulburn Valley Water Solar Farms

Project No. 12597414
Revision No. A
Date 07/12/2023

Vegetation

Figure 5.3

5.4 Visual analysis

5.4.1 Sensitive visual receptors

The site inspection revealed the likely viewshed for the project would primarily be confined to areas within close proximity to the project site, such as road users on Dhurringile Road and Toolamba-Rushworth Road. The presence of the perimeter windrow planting for weather protection would provide some screening of the project from this direction.

Key views are typically achieved from open setting locations along the roads adjacent to the Project site. Of particular note are the following:

- Local filtered views along Dhurringile Road Toolamba- Rushworth Road, Murton Road and Murchison-Tatura Road
- Likely private filtered views from rural residential areas along Dhurringile Road, Toolamba- Rushworth Road Murton Road and Pogue Road
- Filtered views from Goulburn Valley Tree Group community planting reserve
- Static and direct views from the GVW WMF facilities

5.4.2 Key visual features

Based on the desktop review and project site inspection, the key visual features in the study area were identified as:

- Farmland adjacent to the Project site mainly comprises of paddocks in gridded formation, for rearing livestock or agricultural cropping, with irrigation channels and low-lying areas visually prominent within the vast paddocks. These spaces have a sense of openness with relatively flat topography, allowing for open long views from the adjacent roads.
- Extensive open plains and undulating hills containing remanent native grassland and scattered woodland vegetation
- Scattered large sheds, warehouses, fencing, silos, and storage areas related to agricultural practices are visible within the open farmland
- The existing GVW Wastewater Management Facilities (WMF) is partially visible from adjoining roads through the perimeter planning along the site boundaries
- Goulburn Valley Tree Group – Part of the Victorian Landcare Gateway initiative located north of the site on Dhurringile Road
- Tatura township, featuring a number of well-preserved heritage buildings and facilities including the Old Court House, Victory Hall, German Cemetery and Dhurringile Mansion
- Irrigation channels cut a deep and narrow gully through the landscape
- Meandering streams with chains of ponds and tributaries are present within the landscape with scattered established canopy trees and grasses
- The Dhurringile Rd, a single carriageway, two-way asphalt road, is a key access route to the township of Tatura from the south
- Stuart Murray Canal and the Waranga Basin are located approximately five kilometres southwest of the Project site. Facilities along the Waranga Basin foreshore include picnic and barbeque areas and caravan parks. The Waranga Basin and the surrounding landscape is a family-friendly regional destination that provides bushwalking, birdwatching, horse riding and cycling.

**ADVERTISED
PLAN**

This copied document to be made available for the sole purpose of enabling its consideration and review as part of a planning process under the Planning and Environment Act 1987. The document must not be used for any purpose which may breach any copyright

6. Landscape impact assessment

Based on the review of the existing landscape context, landscape character areas (LCAs) were defined.

The following LCAs were identified for the study area:

- LCA1 – Tatura Township
- LCA2 – Farmland

**ADVERTISED
PLAN**

**This copied document to be made available
for the sole purpose of enabling
its consideration and review as
part of a planning process under the
Planning and Environment Act 1987.
The document must not be used for any
purpose which may breach any
copyright**

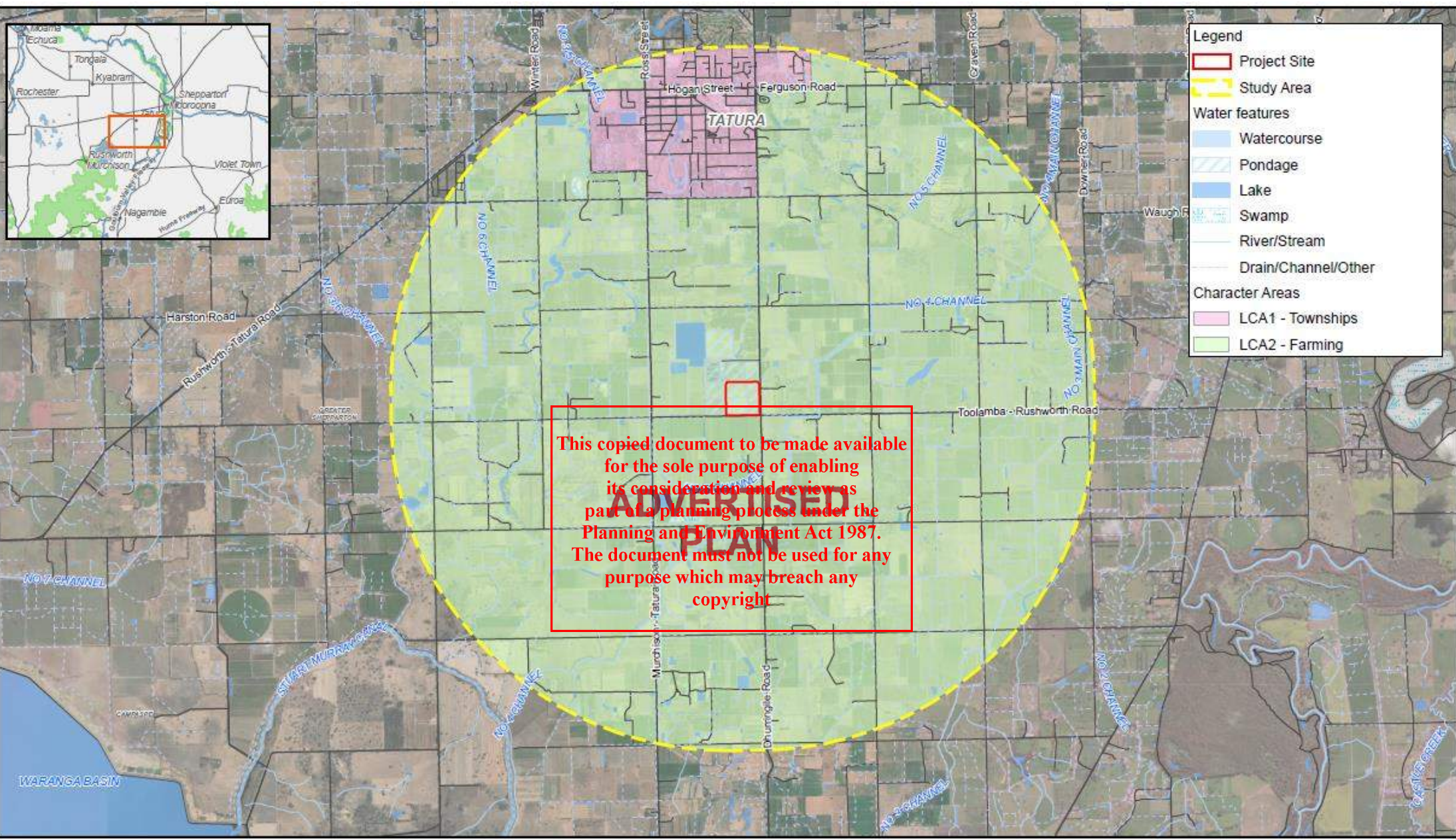
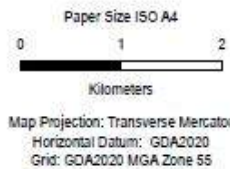

Figure 6.1 Landscape character area



Goulburn Valley Water
Goulburn Valley Water Solar Farms

Project No. 12597414
Revision No. A
Date 07/12/2023

Landscape character zones

Figure 6.1

ADVERTISED PLAN

6.1 Landscape character area 1: Tatura Township

The key features of LCA1 are described below and the characteristic can be seen in Photo 6.1 to Photo 6.6. Refer to Table 6.1 for LCA1 analysis.



Photo 6.1 View from Murton Road, Tatura looking north showing an example of the residential buildings of the town



Photo 6.2 View from O'Reilly Road, Tatura facing north showing Tatura Fire Station

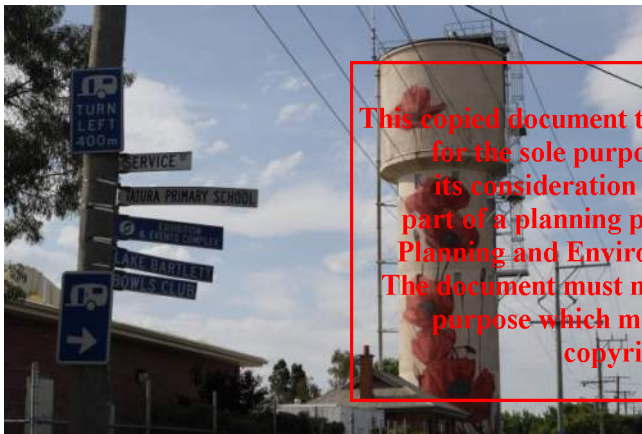

Photo 6.3 View from Ross Street, Tatura looking north west showing the water tower



Photo 6.4 View from Ross Street, Tatura looking north showing example of the industrial area

This copied document to be made available for the sole purpose of enabling its consideration and review as part of a planning process under the Planning and Environment Act 1987. The document must not be used for any purpose which may breach any copyright



Photo 6.5 View from Hogan Street, Tatura showing the main Highstreet through the centre of the township



Photo 6.6 View from Hogan Street, Tatura showing the church as one of the public buildings located throughout the town,

LCA1 primarily encompasses the township of Tatura, approximately five kilometres north of the Project site. Tatura is located in the Goulburn Valley and is one of the richest horticultural intensively farmed areas in Victoria (Greater Shepparton City Council, 2021). Its rivers and irrigation systems have until recent times offered farmers prosperous fertile land for agricultural land uses. Tatura is home to a population of approximately 5,000 people (Australian Bureau of Statistics, 2021) and is characterised by a predominance of one-and two-storey dwellings, contributing to the rural residential character. The presence of heritage listed buildings and landmarks highlight local historic European heritage and overall character of the township.

Table 6.1 Key characteristics of LCA1

Character element	Description
Landform	The township topography is relatively flat with an average elevation of 114 m AHD. Scattered ephemeral river tributaries and ponds form gentle creases in the otherwise generally flat landscape. Gradual falls towards the river tributaries including Lake Bartlett.
Vegetation	Vegetation within the developed areas of Tatura is generally tightly bound by the built environment, with few natural landscape features remaining, including scattered remnant vegetation in Cussen Park and Lake Bartlett. Road reserves within the residential areas typically comprise grassed verges to either side with some established street trees. Public open spaces and recreational facilities within the LCA, including the Hill Top Golf, typically comprise modified landscapes that accommodate open fields used for sporting activities. While vegetation and mature tree plantings are common, these are generally found at perimeter edges.
Waterways/Reserves	Although natural waterways do not primarily define LCA1, it does integrate urban elements like stormwater drains, Lake Bartlet Reserve, a western water-holding pond, and northern oxbow remnants. Key water features include Lake Bartlet, Cussen Park, and Goulburn Murray Water (GMW) irrigation channels and stormwater drains.
Land use	The area is extensively developed with a mix of single storey residential areas and light industrial uses located in the township. With a large number of manufacturing and manufacturing presence within the town, Tatura is a major employer within the Goulburn Valley. Residential areas predominantly comprise 1-2 storey, with some examples of unit-infill development. The character of these residential neighbourhoods is generally consistent, with dwellings located on spacious allotments in a garden setting within a gridded street layout. New estate-style housing development has occurred in the 21 st century, located to the north of the township in close proximity to Hill Top Golf. Neighbourhoods continue to develop and are under construction. Commercial, retail, and civic land uses are mainly located along Hogan Street. The commercial strip includes a small supermarket, hotel/pub and other fine grain retail and food/beverages business. Several public open spaces and recreational facilities are located within the LCA including the Tatura Recreation area and sports, Tatura showgrounds and Tatura Racecourse. In addition to public parks, some small reserves and playgrounds are scattered throughout the residential neighbourhoods.
Cultural and characteristics	Hogan Street is a commercial strip of historic, aesthetic, and social significance to the Greater Shepparton City, and provides tangible physical evidence of the character and type of settlement from the late 1860's and to the Post world War period (Greater Shepparton , 2018). Landmarks within the Hogan Street heritage overlay include Tatura Court House, Victory Hall, Tatura Water Tower, and Sacred Heart Catholic Church. These landmarks and European historic buildings contribute to the overall character of the township. Prior to European settlement the area was home to the Yorta Yorta Aboriginal people. Aboriginal Cultural Heritage Sensitivity areas are notably within 200 metres of rivers and creeks, including Cussen Park.
Spatial qualities	Hogan Street is characterised by the human-scale proportion of buildings that positively contribute to an established and attractive streetscape particularly with regard to buildings that have cultural heritage value. The street trees, furniture and built from provide a sense of place and vitality in the township. Due to flat topography, views within the residential neighbourhoods are closed with some long views into the broader farmland landscape from the periphery of the township.

**ADVERTISED
PLAN**

Landscape values associated with LCA1 include local policy objectives to preserve the environmental qualities of existing remanent natural features and the historical buildings and landmarks. Landscape character elements are in reasonably good condition and/or make a contribution to the local character, including locally important landscape features and historical landmarks, therefore LCA1 has a **Medium** landscape value.

Table 6.2 Landscape impact assessment

Criteria	Assessment
Anticipated change	The project would occur outside LCA1 and therefore would not directly impact the landscape character. During construction and operation distant, filtered views may be achieved from Dhurringile Road of light vehicles traveling to and from the site.
Landscape susceptibility to change	Low , as the anticipated change would be unlikely to have a significant adverse effect on the landscape character, condition or value that could not be mitigated.
Sensitivity of the landscape to change	The sensitivity of a landscape is judged on a combination of the landscape value and the landscape's susceptibility to change from the type of proposed development. The sensitivity would be Low , as the susceptibility to accommodate the proposed change is considered Low, the landscape value is medium, and the development is not within LCA1.
Magnitude of change	The magnitude of change would be Negligible , as there would be no change to existing landscape character as the project is outside of LCA1. Although views to the construction and operation of the project may be achieved, views to LCZ2 are not a key feature of LCA1 and therefore the anticipated changes do not significantly impact the landscape character.
Significance of impact	The significance of impact would be Negligible , as the sensitivity is Low and the magnitude is Negligible .

ADVERTISED PLAN

This copied document to be made available for the sole purpose of enabling its consideration and review as part of a planning process under the Planning and Environment Act 1987. The document must not be used for any purpose which may breach any copyright

ADVERTISED PLAN

6.2 Landscape character area 2: Farmland

The key features of LCA2 are described below and the characteristic can be seen in **Photo 6.7** to Photo 6.12. Refer to Table 6.3 for LCA2 analysis.



Photo 6.7 View from Dhurringile Road facing west showing agricultural fields



Photo 6.8 View from Dhurringile Road facing east showing agricultural related infrastructure

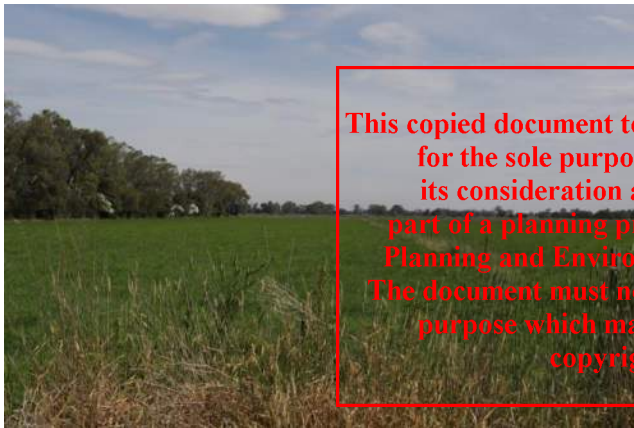

Photo 6.9 View from Pogue Road facing north showing extensive agricultural fields



Photo 6.10 View from Toolamba - Rushworth Road facing north showing irrigation channels associated with agricultural practices



Photo 6.11 View from Dhurringile Road, Toolamba West looking east showing surrounding agricultural fields



Photo 6.12 View Langdon Road, Tatura looking north showing ancillary farming structures and entry gate

This copied document to be made available for the sole purpose of enabling its consideration and review as part of a planning process under the Planning and Environment Act 1987. The document must not be used for any purpose which may breach any copyright

LCA2 is located primarily south of the township of Tatura, including the Project site. The farming activities contribute the LCA2 rural character, featuring expansive paddocks dedicated to agriculture activities. The farmland topography is characterised by flat stretches and gentle undulations within the paddocks. The proximity to the main township of Tatura influences the overall character. Irrigation channels, small dams for agricultural purposes form the main aspects of the hydrological composition of LCA2.

Table 6.3 Key characteristics of LCA2

Character element	Description
Landform	The topography within LCA2 is generally flat with some gentle undulation characteristic of farming landscapes. Murchison North Bushland Reserve is located approximately eight kms southwest of the Project site, at 165 m AHD provides scenic views of the Waranga Basin Reservoir.
Vegetation	The LCA is highly modified; native vegetation has generally been cleared for pastoral crops and agricultural activities. Scattered throughout the farmland paddocks are patches of remnant native vegetation. Perimeter windrow planting for weather protection is typically located along the property boundaries of the paddocks.
Waterways/Reserves	Even though there is a limited presence of water features and river tributaries, a network of irrigation channels and small dams related to agricultural practices are located within the agricultural paddocks.
Land use	Agricultural practices adjacent to the Project site mainly comprise of a diverse range of farming industries including crops, fruit, vegetable cultivation, dairy, sheep and cattle (Greater Shepparton City Council, 2021). A limited number of rural residents within the study area, are situated on large allotments. Dwellings are widely dispersed and typically screened with perimeter windrow planting for weather protection. Ancillary sheds, equipment and other structures associated with farming practices are present. Fencing mostly consists of standard post and wire fencing around paddocks and property boundaries.
Cultural and characteristics	Tatura's agricultural heritage dates back to the 1890's, marked by the establishment of numerous societies and clubs that gave rise to the regional Tatura Wheat Export Movement. Relevant historical agricultural enterprises in Tatura include the cultivation of tomatoes for the production of Rosella sauce, the operation of Tatura's butter factory, Cleckheaton textiles, and the establishment of Bartletts soft drinks factory (Monash University, 2015).
Spatial qualities	LC2 agricultural land use and the open character of the farmland landscape allow for expansive views of the paddocks from the gridded road layout.

Values associated with LCA2 include limited areas of ecological value, particularly habitat links and corridors along the scattered river tributaries and ephemeral watercourses. Even though policies emphasise preserving spatial qualities in rural landscapes, existing infrastructure already exists within the area. This LCA displays highly modified agricultural landscapes, and therefore has a **Low** landscape character value.

**ADVERTISED
PLAN**

This copied document to be made available for the sole purpose of enabling its consideration and review as part of a planning process under the Planning and Environment Act 1987. The document must not be used for any purpose which may breach any copyright

Table 6.4 Landscape impact assessment

Criteria	Assessment
Anticipated change	<p>The project is located within LCA2. Anticipated changes to landscape character during construction works will include the delivery of materials, in-situ concrete pouring, trenching and construction of new switch room and control room, as well as temporary storage areas, fencing and signage. A construction laydown area proposed in the corner of Dhurringile Rd and Toolamba-Rushworth Rd would be partially visible during construction from the adjacent roads.</p> <p>During operation, close-range screened views may be achieved from Dhurringile Rd and Toolamba-Rushworth Rd of the proposed solar PV modules, HV switch room, control room, admin building, transformers, above ground cabling, carpark and all required ancillary equipment.</p> <p>During operation, light vehicles may be present traveling to and from the site, and within the site using the proposed six-metre wide unsealed roads.</p> <p>During construction and operation, views from Dhurringile Rd may be partially screened by the existing embankment lining the site boundary. Additionally existing perimeter tree planting partially screens views towards the Project site.</p>
Landscape susceptibility to change	<p>The susceptibility to change is Low, as it is unlikely that this development would have an adverse effect on the landscape character, condition, or value. Mitigation measures such as appropriate screening within the proposed 30 m minimum buffer zone would be effective in neutralising adverse effects and impacts of construction would be short-term.</p>
Sensitivity of the landscape to change	<p>The sensitivity of the landscape to change is considered Low, as this agricultural landscape is highly modified by human intervention and after construction it would retain the sense of open agricultural plains.</p>
Magnitude of change	<p>The magnitude of change would be Low, as the introduction of components may be new but would not be uncharacteristic within the existing land use within the site. New movement of people and vehicles would be in keeping with existing light industrial activities. Construction impacts are short-term and therefore do not significantly impact the magnitude.</p>
Significance of impact	<p>The significance of impact would be Low, as the sensitivity is Low and the magnitude is Low.</p>

This copied document to be made available for the sole purpose of enabling its consideration and review as part of a planning process under the Planning and Environment Act 1987. The document must not be used for any purpose which may breach any copyright

ADVERTISED PLAN

7. Visual impact assessment

7.1 Viewpoint selection

Based on the visual analysis and site visit undertaken, the locations (refer to Figure 7.1) were selected for visual assessment. Three of these viewpoints were selected for the production of photomontage images to represent proposed views following the completion of the project (refer to Appendix A). Refer to Table 7.1 for viewpoint locations.

Table 7.1 Viewpoint locations

Viewpoint	Location	Sensitive receptor
VP01	Dhurringile Road	Road users, residents, outdoor workers
VP02	Toolamba-Rushworth Rd	Road users, outdoor workers
VP03	Toolamba-Rushworth Rd	Road users, residents, outdoor workers
VP04	Dhurringile Road	Road users, residents, outdoor workers
VP05	Murton Road	Road users, residents
VP06	Pogue Road	Road users, residents, outdoor workers
VP07	Toolamba-Rushworth Rd	Road users, outdoor workers

**ADVERTISED
PLAN**

This copied document to be made available for the sole purpose of enabling its consideration and review as part of a planning process under the Planning and Environment Act 1987. The document must not be used for any purpose which may breach any copyright

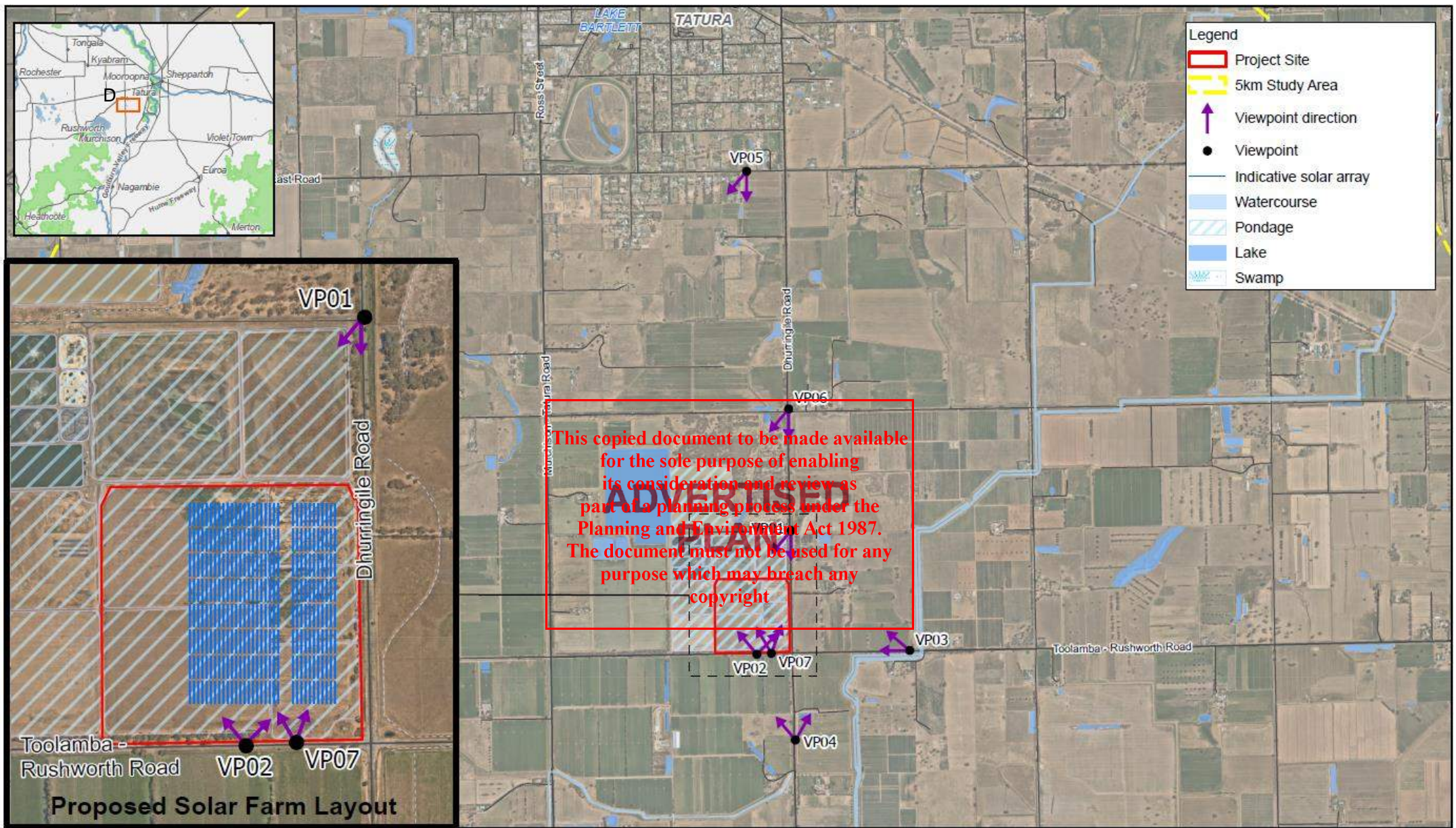

Figure 7.1 Viewpoint location



Goulburn Valley Water
Goulburn Valley Water Solar Farms

Project No. 12597414
Revision No. B
Date 19/01/2024

Viewpoints

Figure 7.1

ADVERTISED PLAN

7.2 Viewpoint location 01 (VP01) Dhurringile Road

VP01 is located on Dhurringile Road and is facing west, as shown in Figure 7.2. Refer to Table 7.2 for assessment.



\\ghdnet\ghd\AU\Melbourne\Projects\3112579414\GIS\Maps\Deliverables\12579414_LVIA_KBM\12579414_LVIA_KBM.aprx\00_12579414_Viewpoint_VP_Location_custom Data source: GHD: Viewpoint (2023); Neamap WMS Server: Created by kgardner
Print date: 08 Dec 2023 - 15:02

Figure 7.2 VP01 location map

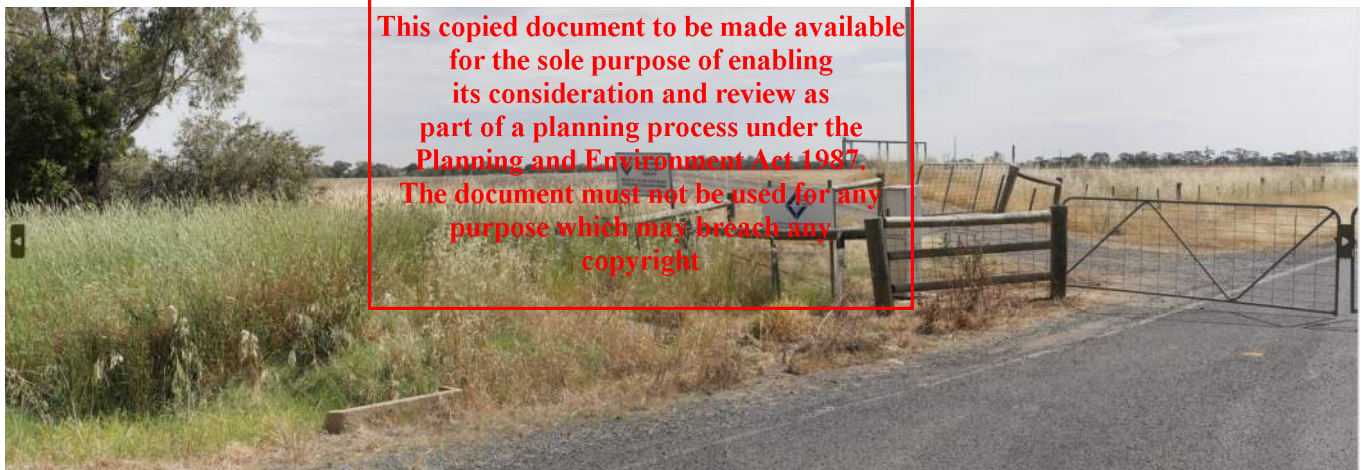

This copied document to be made available for the sole purpose of enabling its consideration and review as part of a planning process under the Planning and Environment Act 1987. The document must not be used for any purpose which may breach any copyright

Photo 7.1 Dhurringile Road existing view



Figure 7.3 Photomontage showing proposed view from Dhurringile Road

ADVERTISED PLAN



Figure 7.4 Redline overlay showing proposed view from Dhurringile Road

Table 7.2 Viewpoint location VP01 assessment

Criteria	Assessment
Location and view direction	<p>GPS location: E: 342411 N: 5961741 Elevation: 114 m</p> <p>VP01 is situated approximately 300 m from the project on Dhurringile Road and is facing west. This viewpoint is representative of road users on Dhurringile Road, and to workers and residents of the surrounding farmland area.</p>
Description of existing view	<p>In the right of the foreground, the wire fence gate indicates the Goulburn Valley Water property boundary. The access road extends into the background and is lined by established eucalyptus and acacia trees and a perimeter fence.</p> <p>To the left of the view, Dhurringile Road's grassed verge slopes towards the drainage channel with a mix of grasses and acacia. Behind the road drainage, a gravel road runs parallel to the property boundary within the GVV property.</p> <p>A vegetated embankment of approximately four metre borders the industrial ponds. Due to the embankment and tall grass vegetation in the foreground, views of the existing wastewater-holding ponds are mostly concealed. Drainage infrastructure, signs, bollards, and ancillary infrastructure are visible through the field of view.</p> <p>The view presents a relatively open rural setting representative of farmland uses. The project site is located adjacent to the left of the existing ponds and extends to the background.</p>
Anticipated change to view	<p>During construction, construction vehicles, machinery and a work crew may be temporarily visible travelling to and from the project site on Dhurringile Road, also within the GVV property. During this time, construction work may create intermittent distant filtered views.</p> <p>During operation, views of the proposed infrastructure would be distant and filtered by the existing vegetation along Dhurringile Road. The proposed boundary wire fence, switch room, and light-vehicles using the unsealed roads may be viewable from this location, behind the proposed 30 m vegetation buffer zone. However, the proposed infrastructure is not uncharacteristic to the site, and at this distance would not have significant changes to the existing view.</p>
Sensitivity to change	The sensitivity is Low , although the viewpoint is located in adjacent to the Project site, road users have passing, short-term, filtered views of the Project site. The focus of the road users is away from the Project site.
Magnitude of change	The magnitude of change would be Low to Negligible due to the existing topography and relatively low height of the proposal, located within the low-lying ex-holding pond. It is anticipated that there would be no change to the key elements, features, or characteristics of the existing view.
Significance of impact	While glimpses of views may occur during the construction phase due to the presence of construction vehicles and machinery, it is expected that during operation the overall significance of impact of the Project on VP01 would be Negligible , as it is anticipated that there would be almost imperceptible change in the view.

ADVERTISED PLAN

7.3 Viewpoint location 02 (VP02) Toolamba-Rushworth Road

VP02 is located on Toolamba-Rushworth Road and is facing north as shown in Figure 7.5. Refer to Table 7.3 for assessment.



Figure 7.5 VP02 location map

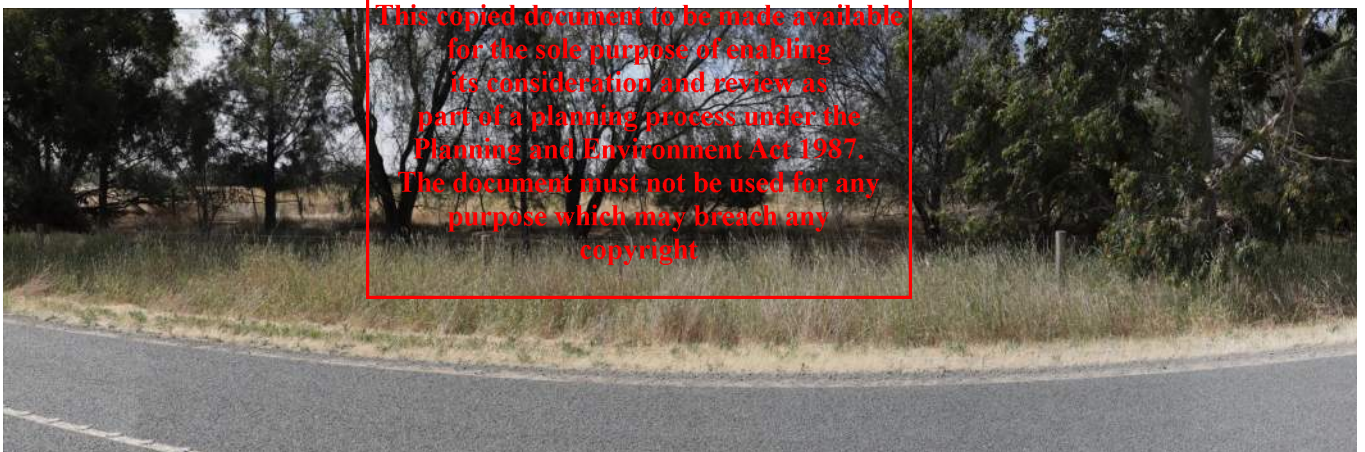

Photo 7.2 Toolamba-Rushworth Road existing view



Figure 7.6 Photomontage showing proposed view from Toolamba -Rushworth Road



Figure 7.7 Redline overlay showing proposed view from Toolamba-Rushworth Road

Table 7.3 Viewpoint location VP02 assessment

Criteria	Assessment
Location and view direction	GPS location: E: 341953 N: 5960897 Elevation: 122 m VP02 is located approximately 30 m south from the site boundary on Toolamba-Rushworth Road and is facing north. This viewpoint is representative of road users on Toolamba-Rushworth Road, workers, and residents in the surrounding farmland areas.
Description of existing view	Toolamba-Rushworth Road extends across the foreground of the view lined by a grassed road reserve with scattered established <i>Eucalyptus</i> and <i>Allocasurina</i> species. Existing roadside vegetation partially filters views towards the Project site adjacent to the road. The view presents a relatively open highly modified rural setting. The project site is located across the midground view, behind the existing vegetation.
Anticipated change to view	During construction, visual impacts may be associated with in-situ concrete pouring and the establishment of new structures and ancillary infrastructure related to the PV generating systems. Construction vehicles, machinery and a work crew may be temporarily visible travelling to and from the project site. During this time, construction work may create intermittent close-range filtered views through the existing roadside established trees. During operation, the introduced infrastructure would be partially screened by the retained vegetation and the proposed 30 m vegetation buffer zone. Partially visible elements within the midground include light-vehicles using the perimetral unsealed road and carpark, rainwater tank to serve de administrative building, administrative building and the boundary wire-fence surrounding the Project. However, due to the existing industrial use of the site, the proposed infrastructure would not be uncharacteristic.
Sensitivity to change	The sensitivity is Low , although the viewpoint is located in close proximity to the Project site, road users have passing, filtered views of the Project site. The focus of the road users is away from the Project site.
Magnitude of change	The magnitude of change is Low , as there would be minor loss or alteration to one or more key view elements, features or characteristics, or the introduction of components that may be visible but may not be uncharacteristic within the existing view.
Significance of impact	While glimpses of views may occur during the construction phase due to the presence of construction vehicles and machinery, it is expected that during operation the overall significance of impact of the Project on VP02 would be Low , as it is anticipated that there would be minor alteration or change in the view.

This copied document to be made available for the sole purpose of enabling its consideration and review as part of a planning process under the Planning and Environment Act 1987. The document must not be used for any purpose which is contrary to copyright.

ADVERTISED
PLAN

7.4 Viewpoint location 03 (VP03) Toolamba-Rushworth Road

VP03 is located on Toolamba-Rushworth Rd and is facing west as shown in Figure 7. Refer to Table 7.4 for assessment.

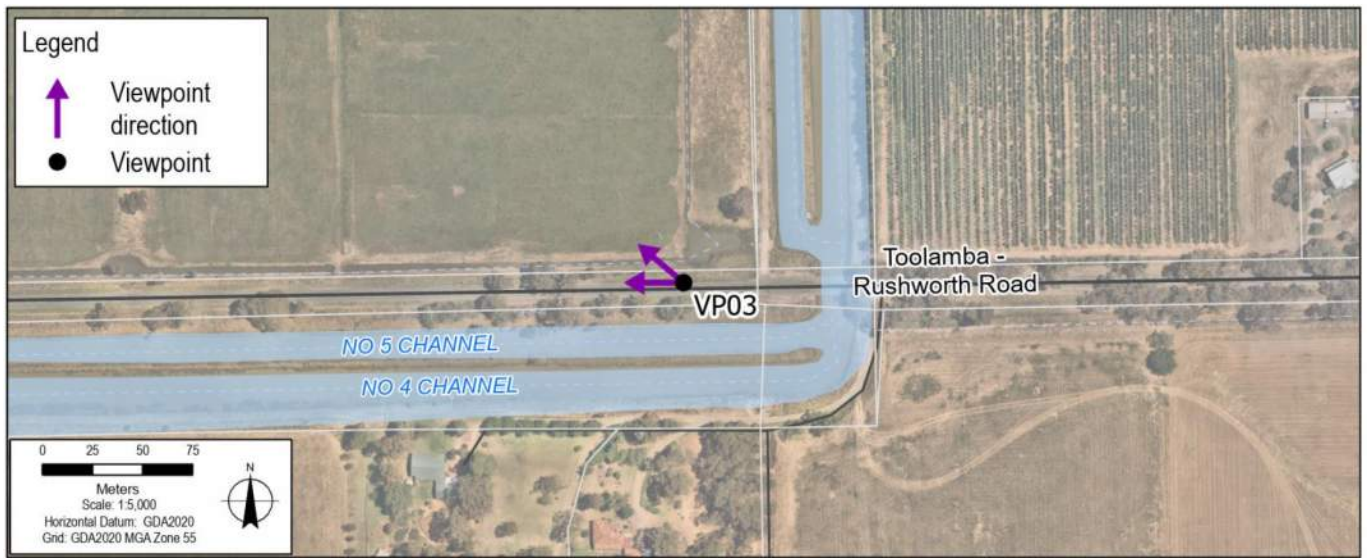

\\ghd\ef\ghd\AU\Melbourne\Projects\311\12579414\GIS\Map\Deliverables\12579414_LVIA_KBM\12579414_LVIA_KBM aprx00_12579414_Viewpoint_VP_Location_custom
Print date: 22 Jan 2024 - 11:01

Data source: GHD: Viewpoint (2023); World Imagery: Maxar
Nearmap WMS Server. Created by kgardner

Figure 7.8 VP03 location map



Photo 7.3 Toolamba-Rushworth Road existing view

**ADVERTISED
PLAN**

This copied document to be made available for the sole purpose of enabling its consideration and review as part of a planning process under the Planning and Environment Act 1987. The document must not be used for any purpose which may breach any copyright

Table 7.4 Viewpoint location VP03 assessment

Criteria	Assessment
Location and view direction	GPS location: E 343270 N: 5960928 Elevation: 122 m VP03 is situated approximately 800 m from the project on Toolamba-Rushworth Road and is facing west. This viewpoint represents road users on Toolamba-Rushworth Road, workers, and residents in the farmland areas.
Description of existing view	The foreground view encompasses the single lane, two-way Toolamba-Rushworth Road, extending into the centre of the background and lined by a grassed verge. To the left of the view, a grassed embankment screens views of the existing irrigation channel in the background. Established trees are present along the road verges in the midground. The open agricultural landscape extends to the right in the background, delineated by a wooden post and wire fencing. Some canopy trees are scattered behind the crop field lining Dhurringile Road. Additionally, two utility poles are present within the view. The scene presents an open setting with a highly modified landscape characteristic of farmland. The project site is located to the right in the background, concealed by existing vegetation.
Anticipated change to view	It is unlikely that the construction and operation of the project would cause any changes to the view from this location, due to the existing vegetation on lining Dhurringile Road and Toolamba-Rushworth Road significantly screening the view and the distance from the project site. Any changes to the view would be almost imperceptible. However, construction vehicles, machinery and a work crew may be temporarily visible travelling to and from the project site along Toolamba-Rushworth Road.
Sensitivity to change	The sensitivity is Low , as road users have passing, filtered views of the Project site. The focus of the road users is away from the Project site.
Magnitude of change	The magnitude of change is Negligible as there is no change to the key elements, features, or characteristics of the existing view.
Significance of impact	While glimpses of views may occur during the construction phase due to the presence of construction vehicles and machinery, it is expected that during operation the overall significance of impact of the Project on VP03 would be Negligible , as it is anticipated that there would be almost imperceptible change in the view.

This copied document to be made available for the sole purpose of enabling its consideration and review as part of a planning process under the Planning and Environment Act 1987. The document must not be used for any purpose which may breach any copyright

ADVERTISED PLAN

7.5 Viewpoint location 04 (VP04) Dhurringile Road

VP04 is located on Dhurringile Road and is facing north as shown in Figure 7.9. Refer to Table 7.5 for assessment.



Figure 7.9 VP04 location map



Photo 7.4 Dhurringile Road existing view

**ADVERTISED
PLAN**

This copied document to be made available for the sole purpose of enabling its consideration and review as part of a planning process under the Planning and Environment Act 1987. The document must not be used for any purpose which may breach any copyright

Table 7.5 Viewpoint location VP04 assessment

Criteria	Assessment
Location and view direction	GPS location: E: 342455 N: 5960313 Elevation: 126 m VP04 is situated approximately 600 m from the project on Dhurringile Road and is facing north. It represents the perspective of road users on Dhurringile Road and workers and residents in the surrounding residential and farmland areas.
Description of existing view	Dhurringile Road extends from the left of the foreground into the centre of the background view. The open agricultural landscape extends from both sides of the road into the background. Lining the road, the perimeter windrow planting comprises of scattered established eucalyptus trees. Utility poles and boundary wire fences are also present within the view. In the background to the right, the dense planting of trees lining Toolamba-Rushworth Road is visible. The view presents an open setting with a highly modified landscape characteristic of the farmland. The project site is located to the right in the background, concealed by the existing vegetation.
Anticipated change to view	It is unlikely that the construction and operation of the project would cause any changes to the view from this location, due to the existing vegetation significantly screening the view and the distance from the project site. Any changes to the view would be imperceptible. However, during construction, there may be a temporary increase in road traffic along Dhurringile Road, including construction vehicles, machinery, and work crews this may result in altered traffic conditions.
Sensitivity to change	The sensitivity is Low , as the focus of the road users is away from the Project site.
Magnitude of change	The magnitude of change is Negligible as there is no change to the key elements, features, or characteristics of the existing view.
Significance of impact	While glimpses of views may occur during the construction phase due to the presence of construction vehicles and machinery, it is expected that during operation the overall significance of impact of the Project on VP04 would be Negligible , as it is anticipated that there would be almost imperceptible change in the view.

This copied document to be made available for the sole purpose of enabling its consideration and review as part of a planning process under the Planning and Environment Act 1987. The document must not be used for any purpose which may breach any copyright

ADVERTISED PLAN

ADVERTISED PLAN

7.6 Viewpoint location 05 (VP05) Murton Road

VP05 is located on Murton road and is facing south as shown in Figure 7.10. Refer to

Table 7.6 Viewpoint location VP05 assessment

for assessment.



\\ghdnet\ghd\AU\Melbourne\Projects\311\2579414\GIS\Maps\Deliverables\12579414_LVIA_RBM\12579414_LVIA_RBM.approx00_12579414_viewpoint_vp_location_custom Data source: GHD; Viewpoint (2023); Neemap WMS Server. Created by kgardner
Print date: 08 Dec 2023 - 15:02

Figure 7.10 VP05 location map

This copied document to be made available
for the sole purpose of enabling
its consideration and review as
part of a planning process under the
Planning and Environment Act 1987.
The document must not be used for any
purpose which may breach any
copyright

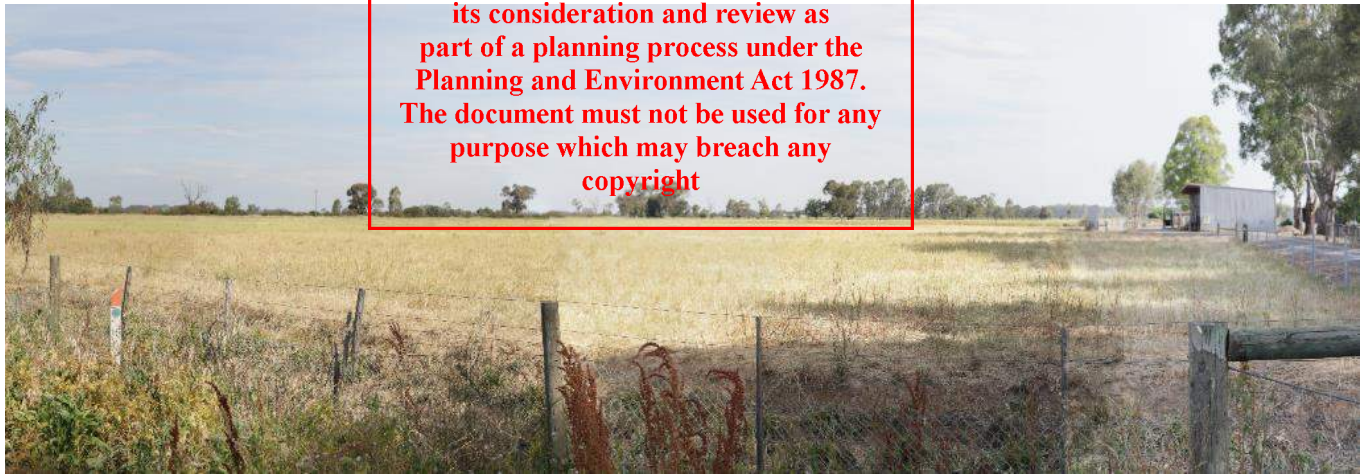

Photo 7.5 Murton Road existing view

Table 7.6 Viewpoint location VP05 assessment

Criteria	Assessment
Location and view direction	GPS location: E: 342100 N: 5964160 Elevation: 124 m VP05 is situated approximately three kms from the project on Murton Road and is facing south. This viewpoint is representative of road users on Murton Road and workers and residents in the surrounding farmland areas.
Description of existing view	The foreground presents a highly modified landscape with an expansive agricultural paddock. The relatively flat topography allows for background views of the windrow tree planting along Dhurringile Road. A wire fence delineates the property boundary of the paddock, situated behind the weedy herbaceous verge. To the right of the view, a private unsealed road extends into the background, lined by scattered established canopy trees. A shed and agricultural-related infrastructure are present to the right of the view.

Criteria	Assessment
	The viewpoint presents an open rural setting typical of the area's farmland. The project site is located to the right in the background, concealed by existing vegetation.
Anticipated change to view	It is unlikely that the construction and operation of the project would cause any changes to the view from this location, due to the low-profile form of the project and the distance from the view. Any changes to the view would be imperceptible. However, construction vehicles, machinery and a work crew may be temporarily visible travelling to and from the project site along Dhurringile Road and Murton Road.
Sensitivity to change	The sensitivity is Moderate , due to residents that place value upon the open rural landscape and enjoyment of views of the open setting.
Magnitude of change	The magnitude of change is Negligible as there is no change to the key elements, features, or characteristics of the existing view.
Significance of impact	While glimpses of views may occur during the construction phase due to the presence of construction vehicles and machinery on Dhurringile Road, it is expected that during operation the overall significance of impact of the Project on VP04 would be Negligible , as it is anticipated that there would be almost imperceptible change in the view.

ADVERTISED PLAN

This copied document to be made available for the sole purpose of enabling its consideration and review as part of a planning process under the Planning and Environment Act 1987. The document must not be used for any purpose which may breach any copyright

7.7 Viewpoint location 06 (VP06) Pogue Road

VP06 is located on Pogue road and is facing south west as shown in Figure 7.11. Refer to Table 7.7 for assessment.

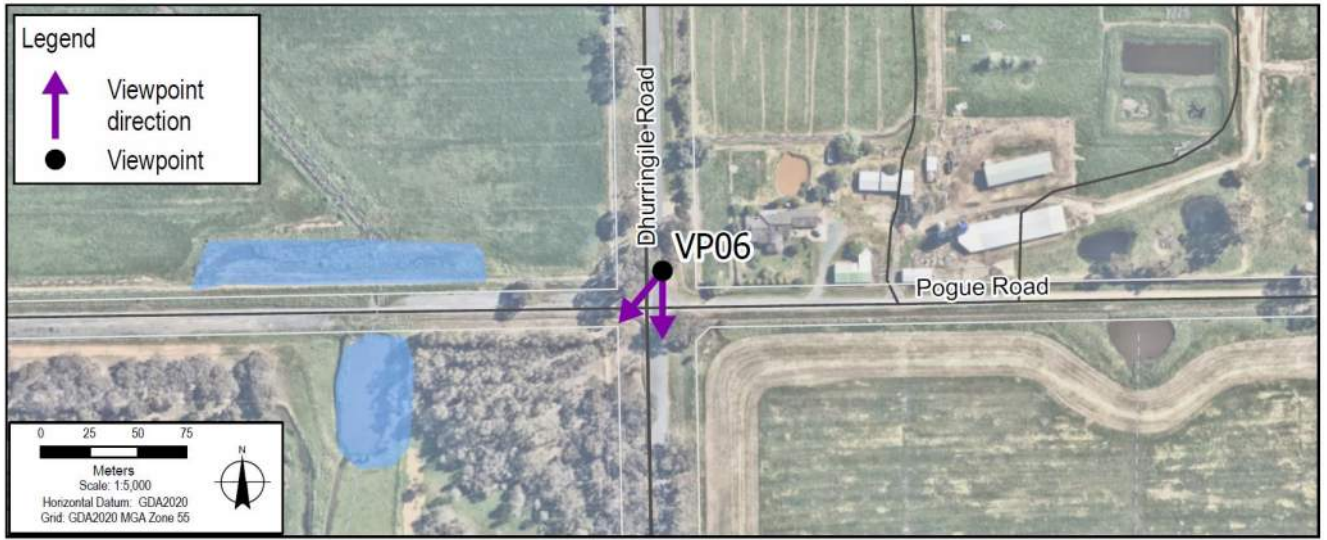

V:\ghdnet\ghd\AU\Melbourne\Projects\311\2579414\GIS\Maps\Deliverables\12579414_LVIA_KBM\12579414_LVIA_KBM.aprx\00_12579414_Viewpoint_VP_Location_custom Data source: GHD: Viewpoint (2023), Nearnmap WMS Server: Created by: kgardner
Print date: 08 Dec 2023 - 15:02

Figure 7.11 VP06 location map



Photo 7.6 Intersection of Pogue Road and Dhurringile Road existing view

**ADVERTISED
PLAN**

This copied document to be made available for the sole purpose of enabling its consideration and review as part of a planning process under the Planning and Environment Act 1987. The document must not be used for any purpose which may breach any copyright

Table 7.7 Viewpoint location VP06 assessment

Criteria	Assessment
Location and view direction	GPS location: E: 342418 N: 5962573 Elevation: 123 m VP06 is situated approximately 800 m from the project on the intersection of Pogue Road and Dhurringile Road and is facing southwest. This viewpoint represents the views of road users on Dhurringile Road, as well as the workers and residents of the surrounding farmland areas.
Description of existing view	Dhurringile Road extends from the right of the foreground into the centre of the background view. The intersection of Pogue Road is visible in the midground view, marked by a street sign at the converging corner. On the left side of Dhurringile Road, the view presents an open setting with a highly modified landscape characteristic of the farmland behind a well-maintained grassed verge and some scattered established trees along the road. To the right of the view, is the Goulburn Valley Tree Group, a former Victorian Landcare Gateway Project. This area features a more natural setting with close views of established and young canopy trees. Eucalyptus and wattles within this area screen the background views towards the project site. The project site is located to the right in the background, concealed by the existing vegetation.
Anticipated change to view	It is unlikely that the construction and operation of the project would cause any changes to the view from this location, due to the existing vegetation significantly screening the view and the distance from the project site. Construction vehicles, machinery and a work crew may be temporarily visible travelling to and from the project site along Dhurringile Road.
Sensitivity to change	The sensitivity is Moderate , as the community place value on the views and densely planted landscape of the Goulburn Valley native plant nursery. The sensitivity is Moderate , as the community place value on the views and densely planted landscape of the Goulburn Valley Tree Group site.
Magnitude of change	The magnitude of change is Negligible as there is no change to the key elements, features, or characteristics of the existing view. Construction impacts are short-term and therefore do not significantly impact the magnitude
Significance of impact	While glimpses of views may occur during the construction phase due to the presence of construction vehicles and machinery on Dhurringile Road, it is expected that during operation the overall significance of impact of the Project on VP06 would be Negligible , as it is anticipated that there would be almost imperceptible change in the view.

This copied document to be made available for the sole purpose of enabling its consideration and review as part of a planning process under the Planning and Environment Act 1987. The document must not be used for any purpose which may breach any copyright

ADVERTISED PLAN

ADVERTISED PLAN

7.8 Viewpoint location 07 (VP07) Toolamba-Rushworth Road

VP07 is located on Toolamba-Rushworth Road and is facing north as show in Figure 7.12. Refer to Table 7.8 for assessment.



Figure 7.12 VP07 location map

This copied document to be made available for the sole purpose of enabling its consideration and review as part of a planning process under the Planning and Environment Act 1987. The document must not be used for any purpose which may breach any copyright

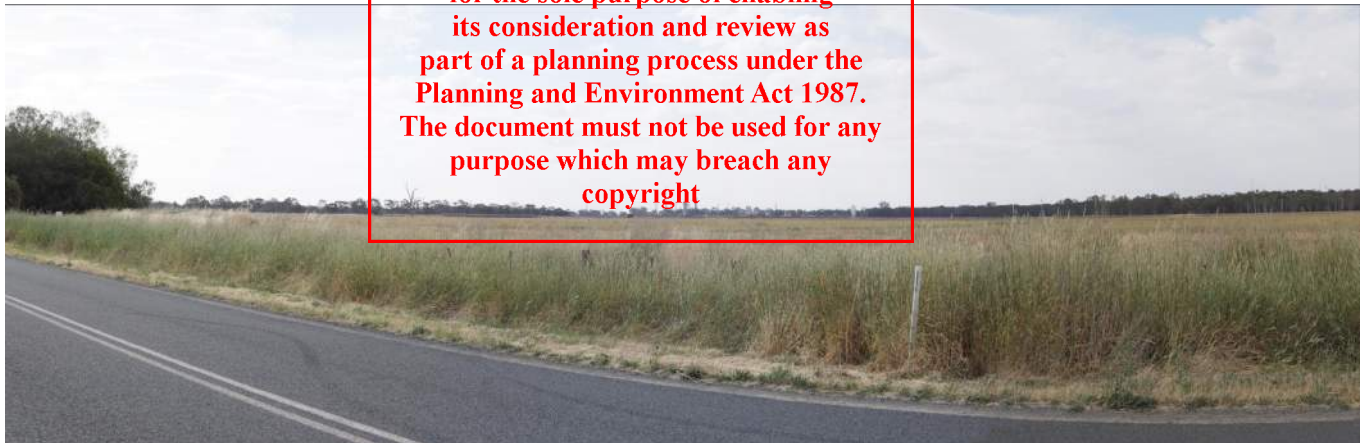

Photo 7.7 Toolamba-Rushworth Road existing view



Figure 7.13 Photomontage showing proposed view from Toolamba-Rushworth Road

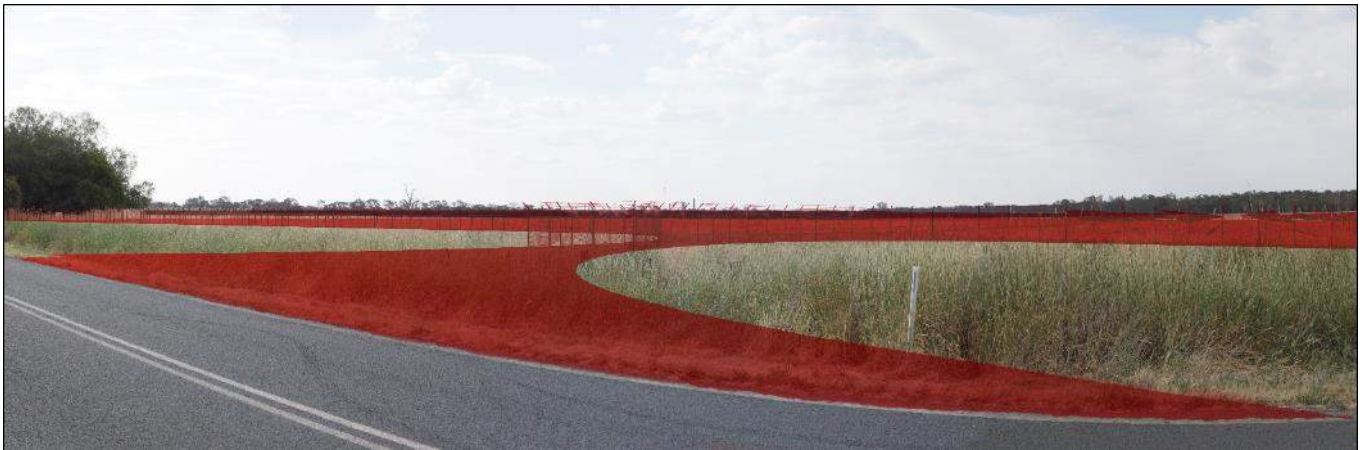

Figure 7.14 Redline overlay showing proposed view from Toolamba-Rushworth Road

Table 7.8 Viewpoint location VP07 assessment

Criteria	Assessment
Location and view direction	GPS location: E: 342298 N: 5960903 Elevation: 129 m VP07 is situated approximately 30 m from the project on Toolamba-Rushworth Road and is facing north. This viewpoint represents the views of road users on Toolamba-Rushworth Road and the workers and residents in the surrounding residential and farmland areas.
Description of existing view	Toolamba-Rushworth Road extends across the foreground of the view lined by a grassed road reserve and a wire fence partially concealed by existing vegetation. The relatively flat topography allows for views of the thick mixed vegetation in the periphery of the existing industrial ponds to the left of the view. Ancillary machinery related to the site's operations is visible in the left of the background view. The view presents an open highly modified rural setting. The Project site is located adjacent to the road and extends across the midground and background of the view.
Anticipated change to view	During construction , the project would be located centre of this view behind Toolamba-Rushworth Road. A construction laydown area would be present to the right, which would be visible within the view. Visual impacts may include in-situ concrete pouring and the establishment of new structures and ancillary infrastructure related to the PV generating systems. Traffic controlled conditions, construction vehicles, machinery and a work crew may be temporarily visible travelling to and from the project site. Open views would be experienced by road users during this time. During operation , the project would be located centre of this view behind Toolamba-Rushworth Road. The administrative building, rainwater tank and ancillary infrastructure would be visible to the left of the midground view, behind the proposed 30 m vegetation buffer zone. The proposed access road, the perimeter wire fence, access gates and ancillary components may be permanent visible elements within this view.
Sensitivity to change	The sensitivity is Low , as road users have passing, distant, filtered views of the project site. The focus of the road users is away from the project site.
Magnitude of change	The magnitude of change is Moderate as there would be discernible changes in the existing view due to partial loss of, or change to elements, features, or characteristics of the view, however, has potential to be partly mitigated. Due to the low-profile form of the majority of the Project, the changes would not be out of scale with the existing view and would not leave an adverse impact on the view.
Significance of impact	During construction machinery, vehicles and the laydown area would be visible from this view, it is expected that during operation the significance of impact is Moderate-Low , as the sensitivity to change is low and the magnitude of change Moderate .

**ADVERTISED
PLAN**

8. Cumulative impact assessment

Cumulative impacts can be defined as the successive, incremental, and combined effect of multiple impacts, which may in themselves be minor, but could become significant when considered together. The study area for the cumulative visual assessment included projects potentially within the same view or landscape.

8.1 Greater Shepparton Solar Farm Proposals

The State Minister for Planning approved permits for the Tatura East (45MW), Tallygaroopna (68MW) and Lemnos (100MW) solar farms, subject to conditions in August 2019. Additionally, GVCE Mooroopna Solar Farm is a large-scale solar photovoltaic (PV) plant proposed for a 30-hectare site on Greater Shepparton City Council owned land at 250 Toolamba Road, Mooroopna, Victoria.

The proposed solar infrastructure is similar in form and scale to the Project, however, changes associated with the solar infrastructure occur outside the five-kilometres study area of the Project.

The overall rating is **negligible**. Even though there is a similarity in scale and form of the developments, these are eight kilometres apart and would not be visible together.

8.2 Tatty Solar Farm utility installation

Tatty Solar Farm is an existing project located north of LCA 1 of similar scale and typology development.

The approved works are part of an upgrade to the existing electrical alignment to create a new connection to the 'Tatty' Solar Farm at 5923 Midland Highway, north of Tatura township.

The overall rating is **negligible**. Even though there is a similarity in the associated energy infrastructure, these are seven kilometres apart and would not be visible together.

**This copied document to be made available
for the sole purpose of enabling
its consideration and review as
part of a planning process under the
Planning and Environment Act 1987.
The document must not be used for any
purpose which may breach any
copyright**

**ADVERTISED
PLAN**

9. Mitigation measures and recommendations

The following section recommends mitigation measures that respond to issues arising within the assessment that have potential to adversely impact on the character of the landscape or views from nearby sensitive visual receptors. The following mitigation recommendations address the most visual elements of the project as well as referencing any relevant considerations drawn from the legislation and policy review.

9.1 General recommendations

General considerations for the detailed design phase include:

- Utilise design strategies to minimise the visual prominence of new components affecting views to and from the Dhurringile Road and Toolamba-Rushworth Road
- Ensure Project design, siting and materiality is of high quality and sympathetic to the existing context of the study area and contributes positively to the existing landscape character values

9.2 Onsite mitigation recommendations

9.2.1 Retain vegetation

Retain vegetation, particularly the mature avenues trees on the boundary of Dhurringile Road and Toolamba-Rushworth Road, as they screen the Proposal. The buffer zone has been set back from the property boundary, allowing for existing vegetation to be retained.

With only some vegetation requiring removal on Toolamba-Rushworth Road for secondary access, most of the existing visual screening is maintained to minimise visual impacts.

9.2.2 Perimeter screen planting

To mitigate views from high sensitivity viewpoints, screen planting around the perimeter of the Project, within the proposed 30 m buffer, would be recommended. The Project has partially exposed boundaries to the east, to Dhurringile Road, and Toolamba-Rushworth Road to the south. These boundaries could potentially be planted with screening species to mitigate views.

The solar PV array and ancillary infrastructure is located approximately 40 m from the eastern site boundary and 50 m from the southern boundary. Planting within the proposed 30 m minimum buffer zone from existing vegetation would mitigate impacts to VP02 and VP07, the receptors with the highest level of visual impact. The low-profile form of the majority of the Project, primarily the solar array, will allow for planting to provide screening within a relatively short period of time.

9.2.3 Material selection

Although the majority of the Project is of a low profile, with a reflective finish through necessity, taller elements such as administrative building and switch room should be clad with non-reflective materials and be finished in a natural or neutral colour, as found in the landscape of the setting.

9.2.4 Construction activity and storage

General considerations for construction activity and storage include:

- Take all practical measures to ensure construction equipment, stockpiles of stored materials, and other visible elements are located in the construction laydown area near the sensitive receptors, particularly VP07 and VP02, are kept tidy and incorporate screening measures where possible
- Fencing for the compound site is to include hoarding or screening material
- The site compound will be kept tidy and general tidiness will be maintained at the end of each shift
- All materials and equipment will be stored within the site compound or within designated work areas

10. Response to key legislation and policy

The Solar Energy Facilities Design and Development Guideline DELWP stipulates:

- An assessment of the visual impact of the proposal on the surrounding landscape
- An assessment of the visual impact on abutting land that is described in a schedule to the National Parks Act 1975 and Ramsar wetlands and coastal areas

The Shepparton Planning Scheme *Clause 53.13 - Renewable Energy Facility (other than wind energy facility)* recommends that the development application includes:

- Accurate visual simulations illustrating the development in the context of the surrounding area and from key public view points
- An assessment of the impact of the proposal on significant views, including visual corridors and sightlines

This Landscape and Visual Impact Assessment (LVIA) is the response to these development and planning scheme requirements. It assesses the landscape character and visual impacts of the proposal, with particular consideration for sensitive landscape and visual receptors, in the area surrounding the proposal.

Refer to the following sections of the report for more detail:

Table 10.1 Relevant legislation and policy

Relevant features/objectives	Response
An understanding of the landscape and visual attributes of the study area.	Refer to section 5 - Existing landscape and visual environment
Identification of sensitivities of landscape and visual receivers in the vicinity of the proposal.	Refer to section 5 - Visual analysis
Assessment of potential landscape and visual impacts associated with the proposal.	Refer to section 6 - Landscape impact assessment and section 7 - Visual impact assessment
Provision of recommendations for mitigating or managing any identified landscape and visual impacts arising from the proposal.	Refer to section 9 - Mitigation measures and recommendations
Accurate visual simulations illustrating the development in the context of the surrounding area and from key public viewpoints.	Refer to section 7 - Visual impact assessment: Viewpoint location 01 (VP01) Dhurringile Road Viewpoint location 02 (VP02) Toolamba-Rushworth Road Viewpoint location 07 (VP07) Toolamba-Rushworth Road

**ADVERTISED
PLAN**

This copied document to be made available for the sole purpose of enabling its consideration and review as part of a planning process under the Planning and Environment Act 1987. The document must not be used for any purpose which may breach any copyright

ADVERTISED PLAN

11. Conclusion

This report has been prepared to assess the potential landscape and visual impacts of a large-scale solar facility for Goulburn Valley Water (GVW) within its Tatura Wastewater Management Facilities (WMF) site.

The Project was reviewed against the following planning permit triggers and a summary response was provided in section 10:

- Clause 53.13 of the Greater Shepparton planning scheme for the approval of the planning permit for the use and development of the land for the purposes of a Solar Energy Facility (Renewable Energy Facility)
- *Solar Energy Facilities - Design and Development Guideline, (Victoria State Government, Department of Environment, Land, Water and Planning, October 2022)*

This Landscape and Visual Impact Assessment (LVIA) aimed to evaluate the existing landscape and visual context and the impacts on landscape character and the visual environment. The study area, located four kilometres south of Tatura, Victoria, is predominantly zoned as Farming Zone (FZ1), with the Project site designated Public Use Service and Utility (PUZ1).

The landscape surrounding the Project site features a flat terrain with gentle slopes toward irrigation channels, characterised by agricultural paddocks and existing waste management facilities.

A total of two landscape character areas were identified within the study area: Farmland (LCA1) and Tatura Township (LCA2). Impacts on LCA1 were deemed as **Low**, associated with the highly modified agricultural landscapes with a presence of existing infrastructure. Impacts on LCA2 were generally **Negligible**. Overall, this assessment found there to be ~~no significant landscape character impacts arising from the project.~~

Table 11.1 Summary of impacts to landscape character impacts

LCZ	Description	Sensitivity to change	Magnitude of change	Overall rating
LCA1	Farmland	Low	Low	Low
LCA2	Tatura Township	Low	Negligible	Negligible

This copied document to be made available for the sole purpose of enabling its consideration and review as part of a planning process under the Planning and Environment Act 1987. The document must not be used for any purpose which may breach any copyright.

Sensitive visual receptors in the study area include road users, residents, and outdoor workers. Seven viewpoint locations were chosen for assessment. The assessment found that the visual impacts ranged from **Moderate** to **Negligible**, as outlined in Table 11.2. The most significant impacts were **Moderate-Low** within the vicinity of **VP07** (Toolamba-Rushworth Road) due to the magnitude of change and the proximity to the project.

Table 11.2 Summary of Visual impacts

Viewpoint	Location	Sensitivity to change	Magnitude of change	Overall rating
VP01	Dhurringile Road	Low	Negligible	Negligible
VP02	Toolamba-Rushworth Road	Low	Low	Low
VP03	Toolamba-Rushworth Road	Low	Negligible	Negligible
VP04	Dhurringile Road	Low	Negligible	Negligible
VP05	Murton Road	Moderate	Negligible	Negligible
VP06	Pogue Road	Moderate	Negligible	Negligible
VP07	Toolamba-Rushworth Road	Low	Moderate	Moderate-Low

Mitigation includes measures to minimise visual prominence. On-site mitigation recommendations include retaining existing vegetation, particularly mature avenue trees along Dhurringile Road and Toolamba-Rushworth Road and implementing perimeter screen planting within a proposed 30-meter buffer zone to mitigate views from high-sensitivity viewpoints. Material selection and construction activity measures have also been outlined to minimise visual impacts and maintain tidiness throughout the project.

Recommendations:

- Retain existing vegetation, particularly mature avenue trees along Dhurringile Road and Toolamba-Rushworth Road, to maintain visual screening
- Implement perimeter screen planting within a proposed 30-meter buffer zone to mitigate views from high-sensitivity viewpoints
- Use non-reflective materials and natural or neutral colours for taller elements such as administrative buildings and switch rooms to blend with the landscape
- Ensure construction activity and storage are conducted tidily and incorporate screening measures near sensitive receptors, such as VP07 and VP02
- Use hoarding or screening material for fencing around the compound site and maintain general tidiness throughout construction activities

ADVERTISED PLAN

This copied document to be made available for the sole purpose of enabling its consideration and review as part of a planning process under the Planning and Environment Act 1987. The document must not be used for any purpose which may breach any copyright

12. References

- Australian Institute of Landscape Architect (2018), *Guidance Note for Landscape and Visual Impact Assessment*. (n.d.).
- Australian Bureau of Statistics. (2021). *Tatura (State Suburb) Census*. Australian Bureau of Statistics.
- Greater Shepparton . (2018). *Greater Shepparton Heritage Study Stage IIB*. Tatura : Greater Shepparton.
- Greater Shepparton City Council. (2021). *Greater Shepparton City Council COUNCIL PLAN 2021–2025*. Greater Shepparton City Council.
- IEMA. (2002). *Guidelines for Landscape and Visual Impact Assessment*. Taylor & Francis.
- Monash University. (2015). *Tatura*. Retrieved from victorian places: <https://www.victorianplaces.com.au/tatura>
- Pana, M. (2023). *Tatura Site Layout Plan*. GHD.
- Ruzzene , M., & Ainsaar, K. (2016). *MITCHELL SHIRE ECONOMIC DEVELOPMENT STRATEGY*. MITCHELL SHIRE COUNCIL.
- Transport for New South Wales. (2020). *Environmental impact assessment practice note EIA-N04 - Guideline for landscape character and visual impact assessment, Version 2.2*.
- CSIRO (2009), *Australian Soil and Land Survey Field Handbook Third Edition*.(n.d.).
- Australian Bureau of Statistics. (2021). *Tatura (State Suburb) Census*. Australian Bureau of Statistics.
- Greater Shepparton . (2018). *Greater Shepparton Heritage Study Stage IIB*. Tatura : Greater Shepparton.
- Greater Shepparton City Council. (2021). *Greater Shepparton City Council COUNCIL PLAN 2021–2025*. Greater Shepparton City Council.
- IEMA. (2002). *Guidelines for Landscape and Visual Impact Assessment*. Taylor & Francis.
- Monash University. (2015). *Tatura*. Retrieved from victorian places: <https://www.victorianplaces.com.au/tatura>
- Pana, M. (2023). *Tatura Site Layout Plan*. GHD.
- Ruzzene , M., & Ainsaar, K. (2016). *MITCHELL SHIRE ECONOMIC DEVELOPMENT STRATEGY*. MITCHELL SHIRE COUNCIL.
- Transport for New South Wales. (2020). *Environmental impact assessment practice note EIA-N04 - Guideline for landscape character and visual impact assessment, Version 2.2*.
- Landscape Institute and Institute of Environmental Management & Assessment, UK (2013), *Guidelines for Landscape and Visual Impact Assessment, Third Edition*.
- Landscape Institute (2019), *Visual Representation of Development Proposals, Technical Guidance Note 06/19*.
- Land Use Consultants and C Swanwick, *Landscape Character Assessment Guidance, 2011 Revision*.
- Consultation Draft for Natural England, Scottish Natural Heritage and Countryside Council for Wales, 2011.
- Pana, M. (2023). *Tatura Site Layout Plan*. GHD.
- Scottish Natural Heritage (2012), *Assessing the Cumulative Impact of Onshore Wind Energy Developments*.
- Scottish Natural Heritage (2006), *Topic Paper 6: Techniques and Criteria for Judging Capacity and Sensitivity*.

**ADVERTISED
PLAN**

This copied document to be made available for the sole purpose of enabling its consideration and review as part of a planning process under the Planning and Environment Act 1987. The document must not be used for any purpose which may breach any copyright

Appendices

**ADVERTISED
PLAN**

**This copied document to be made available
for the sole purpose of enabling
its consideration and review as
part of a planning process under the
Planning and Environment Act 1987.
The document must not be used for any
purpose which may breach any
copyright**

Appendix A

Photomontages

This copied document to be made available for the sole purpose of enabling its consideration and review as part of a planning process under the Planning and Environment Act 1987. The document must not be used for any purpose which may breach any copyright

ADVERTISED
PLAN

EXISTING VIEW



PROPOSED DESIGN



This copied document to be made available for the sole purpose of enabling its consideration and review as part of a planning process under the Planning and Environment Act 1987. The document must not be used for any purpose which may breach any copyright

ADVERTISED PLAN

KEY PLAN



View Direction: 185° - 265°
Horizontal Field Of View: 80°
Camera Height: 1.7 m
Camera Type: Canon EOS 6D
Lens Type: 50 mm
Photograph Time & Date: 14:41, 20th November 2023

Location: Dhurringle Road, Tatura, Victoria
Coordinates: 342411, 5961741 (GDA 2020 MGA Zone 55)
Viewpoint Elevation: 114 m
Date of Photomontage: 15th December 2023
Issue: v 01

Goulburn Valley Water
Goulburn Valley Water Solar Farm - Tatura
Viewpoint 01: Dhurringle Road

GHD Pty Ltd
 Level 8, 180 Lonsdale Street
 Melbourne VIC 3000
 T 61 3 8687 8000 E melmail@ghd.com.au W www.ghd.com

DESIGN OVERLAY
HIGHLIGHT



ADVERTISED PLAN

This copied document to be made available for the sole purpose of enabling its consideration and review as part of a planning process under the Planning and Environment Act 1987. The document must not be used for any purpose which may breach any copyright

KEY PLAN



View Direction: 185° - 265°
Horizontal Field Of View: 80°
Camera Height: 1.7 m
Camera Type: Canon EOS 6D
Lens Type: 50 mm
Photograph Time & Date: 14:41,
20th November 2023

Location: Dhurringile Road, Tatura,
Victoria
Coordinates: 342411, 5961741
(GDA 2020 MGA Zone 55)
Viewpoint Elevation: 114 m
Date of Photomontage: 15th December 2023
Issue: v 01

Goulburn Valley Water
Goulburn Valley Water Solar Farm - Tatura
Viewpoint 01: Dhurringile Road



GHD Pty Ltd
Level 8, 180 Lonsdale Street
Melbourne VIC 3000
T 61 3 8687 8000 E melmail@ghd.com.au W www.ghd.com



EXISTING VIEW

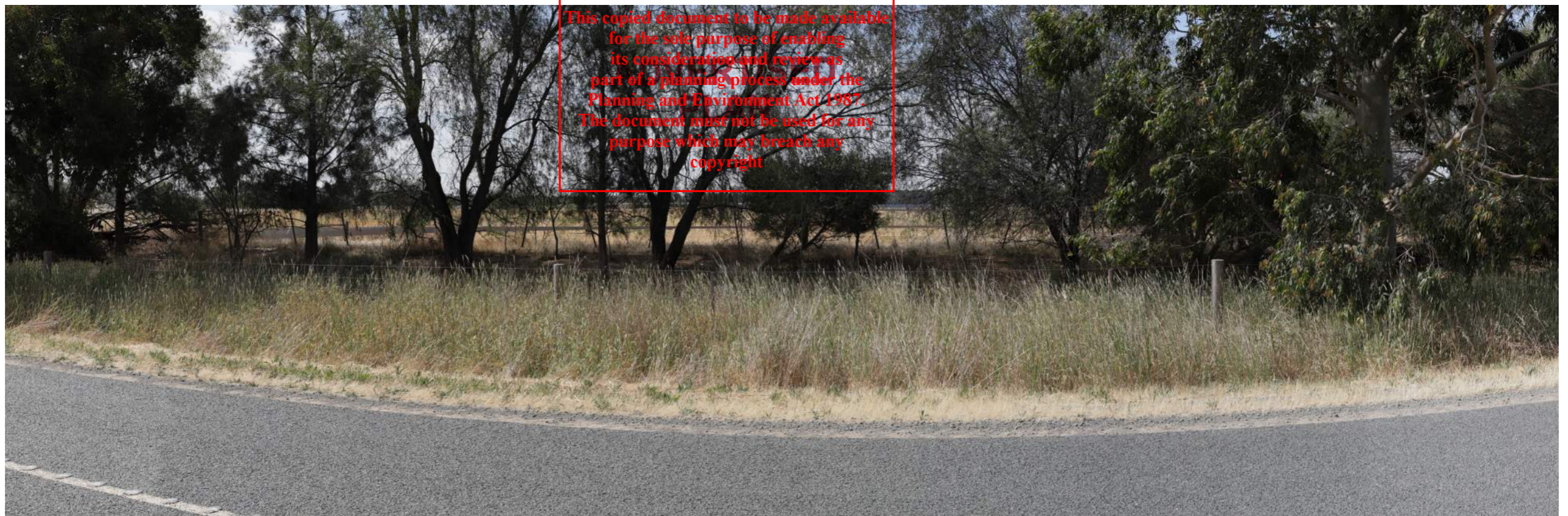

This copied document to be made available for the sole purpose of enabling its consideration and review as part of a planning process under the Planning and Environment Act 1987. The document must not be used for any purpose which may breach any copyright

PROPOSED DESIGN

KEY PLAN



View Direction: 336° - 56°
 Horizontal Field Of View: 80°
 Camera Height: 1.7 m
 Camera Type: Canon EOS 6D
 Lens Type: 50 mm
 Photograph Time & Date: xx:xx, 20th November 2023

Location: Toolamba - Rushworth Road, Tatura, Victoria
 Coordinates: 341953, 5960897 (GDA 2020 MGA Zone 55)
 Viewpoint Elevation: 122 m
 Date of Photomontage: 15th December 2023
 Issue: v 01

Goulburn Valley Water
 Goulburn Valley Water Solar Farm - Tatura

Viewpoint 02: Toolamba-Rushworth Road



GHD Pty Ltd
 Level 8, 180 Lonsdale Street
 Melbourne VIC 3000
 T 61 3 8687 8000 E melmail@ghd.com.au W www.ghd.com



DESIGN OVERLAY
HIGHLIGHT

ADVERTISED PLAN

This copied document to be made available for the sole purpose of enabling its consideration and review as part of a planning process under the Planning and Environment Act 1987. The document must not be used for any purpose which may breach any copyright

KEY PLAN



View Direction: 336° - 56°
 Horizontal Field Of View: 80°
 Camera Height: 1.7 m
 Camera Type: Canon EOS 6D
 Lens Type: 50 mm
 Photograph Time & Date: 14:57,
 20th November 2023

Location: Toolamba - Rushworth Road,
 Tatura, Victoria
 Coordinates: 341953, 5960897
 (GDA 2020 MGA Zone 55)
 Viewpoint Elevation: 122 m
 Date of Photomontage: 15th December 2023
 Issue: v 01

Goulburn Valley Water
 Goulburn Valley Water Solar Farm - Tatura

Viewpoint 02: Toolamba - Rusworth
 Road



GHD Pty Ltd
 Level 8, 180 Lonsdale Street
 Melbourne VIC 3000
 T 61 3 8687 8000 E melmail@ghd.com.au W www.ghd.com

ADVERTISED PLAN



EXISTING VIEW



This copied document to be made available for the sole purpose of enabling its consideration and review as part of a planning process under the Planning and Environment Act 1987. The document must not be used for any purpose which may breach any copyright

PROPOSED DESIGN

KEY PLAN



View Direction: 354° - 74°
 Horizontal Field Of View: 80°
 Camera Height: 1.7 m
 Camera Type: Canon EOS 6D
 Lens Type: 50 mm
 Photograph Time & Date: 15:10,
 20th November 2023

Location: Toolamba - Rushworth Road,
 Tatura, Victoria
 Coordinates: 342298, 5960903
 (GDA 2020 MGA Zone 55)
 Viewpoint Elevation: 116 m
 Date of Photomontage: 15th December 2023
 Issue: v 01

Goulburn Valley Water
Goulburn Valley Water Solar Farm - Tatura

Viewpoint 07: Toolamba - Rushworth
 Road

GHD Pty Ltd
 Level 8, 180 Lonsdale Street
 Melbourne VIC 3000
 T 61 3 8687 8000 E melmail@ghd.com.au W www.ghd.com



DESIGN OVERLAY
HIGHLIGHT

ADVERTISED PLAN

This copied document to be made available for the sole purpose of enabling its consideration and review as part of a planning process under the Planning and Environment Act 1987. The document must not be used for any purpose which may breach any copyright

KEY PLAN



View Direction: 354° - 74°
 Horizontal Field Of View: 80°
 Camera Height: 1.7 m
 Camera Type: Canon EOS 6D
 Lens Type: 50 mm
 Photograph Time & Date: 15:10,
 20th November 2023

Location: Toolamba - Rushworth Road,
 Tatura, Victoria
 Coordinates: 342298, 5960903
 (GDA 2020 MGA Zone 55)
 Viewpoint Elevation: 116 m
 Date of Photomontage: 15th December 2023
 Issue: v 01

Goulburn Valley Water
 Goulburn Valley Water Solar Farm - Tatura

Viewpoint 07: Toolamba - Rushworth
 Road



GHD Pty Ltd
 Level 8, 180 Lonsdale Street
 Melbourne VIC 3000
 T 61 3 8687 8000 E melmail@ghd.com.au W www.ghd.com



This copied document to be made available
for the sole purpose of enabling
its consideration and review as
part of a planning process under the
Planning and Environment Act 1987.
The document must not be used for any
purpose which may breach any
copyright

Appendix B

Traffic Impact Assessment

This copied document to be made available for the sole purpose of enabling its consideration and review as part of a planning process under the Planning and Environment Act 1987. The document must not be used for any purpose which may breach any copyright



**ADVERTISED
PLAN**

Goulburn Valley Water-Tatura Solar Farm

Traffic Impact Assessment

Goulburn Valley Water

08 March 2024



This copied document to be made available for the sole purpose of enabling its consideration and review as part of a planning process under the Planning and Environment Act 1987. The document must not be used for any purpose which may breach any copyright

→ **The Power of Commitment**



**This copied document to be made available
for the sole purpose of enabling
its consideration and review as
part of a planning process under the
Planning and Environment Act 1987.
The document must not be used for any
purpose which may breach any
copyright**

ADVERTISED PLAN

Project name		Goulburn Valley Water Solar Farms					
Document title		Goulburn Valley Water-Tatura Solar Farm Traffic Impact Assessment					
Project number		12579414					
File name		12579414 - REP - Goulburn Valley Water Tatura Solar Farm - Traffic Impact Assessment.docx					
Status Code	Revision	Author	Reviewer		Approved for issue		
			Name	Signature	Name	Signature	Date
S4	0	S.Talukder	Toby Cooper		Michael Goode		08/03/2024

GHD Pty Ltd | ABN 39 008 488 373

Contact: Sourav Talukder, Senior Traffic Engineer | GHD

180 Lonsdale Street, Level 9

Melbourne, Victoria 3000, Australia

T +61 3 8687 8000 | F +61 3 8732 7046 | E melmail@ghd.com | ghd.com

© GHD 2024

This document is and shall remain the property of GHD. The document may only be used for the purpose for which it was commissioned and in accordance with the Terms of Engagement for the commission. Unauthorised use of this document in any form whatsoever is prohibited.

Contents

1. Introduction		1
1.1	Purpose of this report	1
1.2	Scope and limitations	1
1.3	Assumptions	1
2. Existing conditions		2
2.1	Subject site	2
2.2	Planning zones	3
2.3	Road network	4
	2.3.1 Dhurringile Road	4
	2.3.2 Toolamba-Rushworth Road	5
2.4	Sustainable transport	6
2.5	Crash analysis	6
3. Proposed development		8
3.1	General	8
3.2	Site access	9
3.3	Parking	9
4. Traffic considerations		10
4.1	Traffic generation	10
	4.1.1 Construction period	10
	4.1.2 Operation period	10
4.2	Traffic distribution	10
4.3	Traffic impact	11
5. Design considerations		12
5.1	Site access	12
	5.1.1 Turn lane warrant assessment	12
	5.1.2 Sight distance assessment	13
5.2	On-site parking	13
6. Major truck access routes		15
7. Conclusions		18

**This copied document to be made available
 for the sole purpose of enabling
 its consideration and review as
 part of a planning process under the
 Planning and Environment Act 1987.
 The document must not be used for any
 purpose which may breach any
 copyright**

**ADVERTISED
 PLAN**

Figure index

Figure 1	Subject site location	2
Figure 2	Subject site aerial image	3
Figure 3	Planning scheme zones	4
Figure 4	Dhurringile Road facing north adjacent to subject site	5
Figure 5	Toolamba-Rushworth Road facing west adjacent to subject site	6
Figure 6	Crash location surrounding subject site.	7
Figure 7	Proposed site layout	9

Figure 8	Anticipated AM Peak hour construction traffic movements at Toolamba-Rushworth Road and proposed Site Access intersections	11
Figure 9	Anticipated PM Peak hour construction traffic movements at Toolamba-Rushworth Road and proposed Site Access intersections	11
Figure 10	Turn Lane warrant assessment for construction traffic	12
Figure 11	Sight distance assessment for east access	13
Figure 12	Sight distance assessment for west access	13
Figure 13	Greater Shepparton planning scheme clause 52.06-9 requirement for car parking space design	14
Figure 14	Truck access route to and from east	15
Figure 15	Truck access routes to and from west	16
Figure 16	OSOM map surrounding subject site	17

Appendices

Appendix A	Development Plan
Appendix B	Swept Path Assessment

ADVERTISED PLAN

This copied document to be made available for the sole purpose of enabling its consideration and review as part of a planning process under the Planning and Environment Act 1987. The document must not be used for any purpose which may breach any copyright

1. Introduction

GHD Pty Ltd (GHD) has been engaged by Goulburn Valley Water (GVW) to undertake a traffic impact assessment of a proposed solar farm at Dhurringile Road in Tatura, approximately 20 kilometres to the southwest of Shepparton.

In the course of preparing this assessment, the subject site and its environs have been reviewed using latest aerial imagery and plans of the development.

1.1 Purpose of this report

The purpose of this report is to provide an assessment of the impacts of traffic generated by the proposed solar farm development. It is intended that this report accompany a town planning submission by GVW to the Greater Shepparton City Council.

1.2 Scope and limitations

This report: has been prepared by GHD for Goulburn Valley Water and may only be used and relied on by Goulburn Valley Water for the purpose agreed between GHD and Goulburn Valley Water as set out in this report.

GHD otherwise disclaims responsibility to any person other than Goulburn Valley Water arising in connection with this report. GHD also excludes implied warranties and conditions, to the extent legally permissible.

The services undertaken by GHD in connection with preparing this report were limited to those specifically detailed in the report and are subject to the scope limitations set out in the report.

The opinions, conclusions and any recommendations in this report are based on conditions encountered and information reviewed at the date of preparation of the report. GHD has no responsibility or obligation to update this report to account for events or changes occurring subsequent to the date that the report was prepared.

The opinions, conclusions and any recommendations in this report are based on assumptions made by GHD described in this report. GHD disclaims liability arising from any of the assumptions being incorrect.

Accessibility of documents

If this report is required to be accessible in any other format, this can be provided by GHD upon request and at an additional cost if necessary.

1.3 Assumptions

The following are assumed in the preparation of this document:

- Traffic data obtained is representative of a normal weekday activity in the study area.
- Traffic volumes at the site access are assumed to be approximately equal to those recorded by the Department of Transport (DTP) at the nearest counting location.
- This is a desktop assessment based on aerial photography and the information available at the time. No site visit was undertaken.
- The solar farm system is delivered in shipping containers and assembled and connected by on-site activity.
- General construction equipment will be transported to site via rigid trucks, with the solar farm components being delivered by 19 m semi-trailers and 26 m B-double trucks.

This copied document to be made available for the sole purpose of enabling its consideration and review as part of a planning process under the Planning and Environment Act 1987. The document must not be used for any purpose which may breach any copyright

**ADVERTISED
PLAN**

2. Existing conditions

2.1 Subject site

The subject site is located within the existing Tatura Wastewater Management Facility (WMF) site along Dhurringile Road, Tatura approximately 4.4 km south of the Tatura township area as shown in Figure 1.

The site is bounded by Dhurringile Road to the east and Toolamba-Rushworth Road to the south.

An aerial imagery of the subject site is presented in Figure 2.

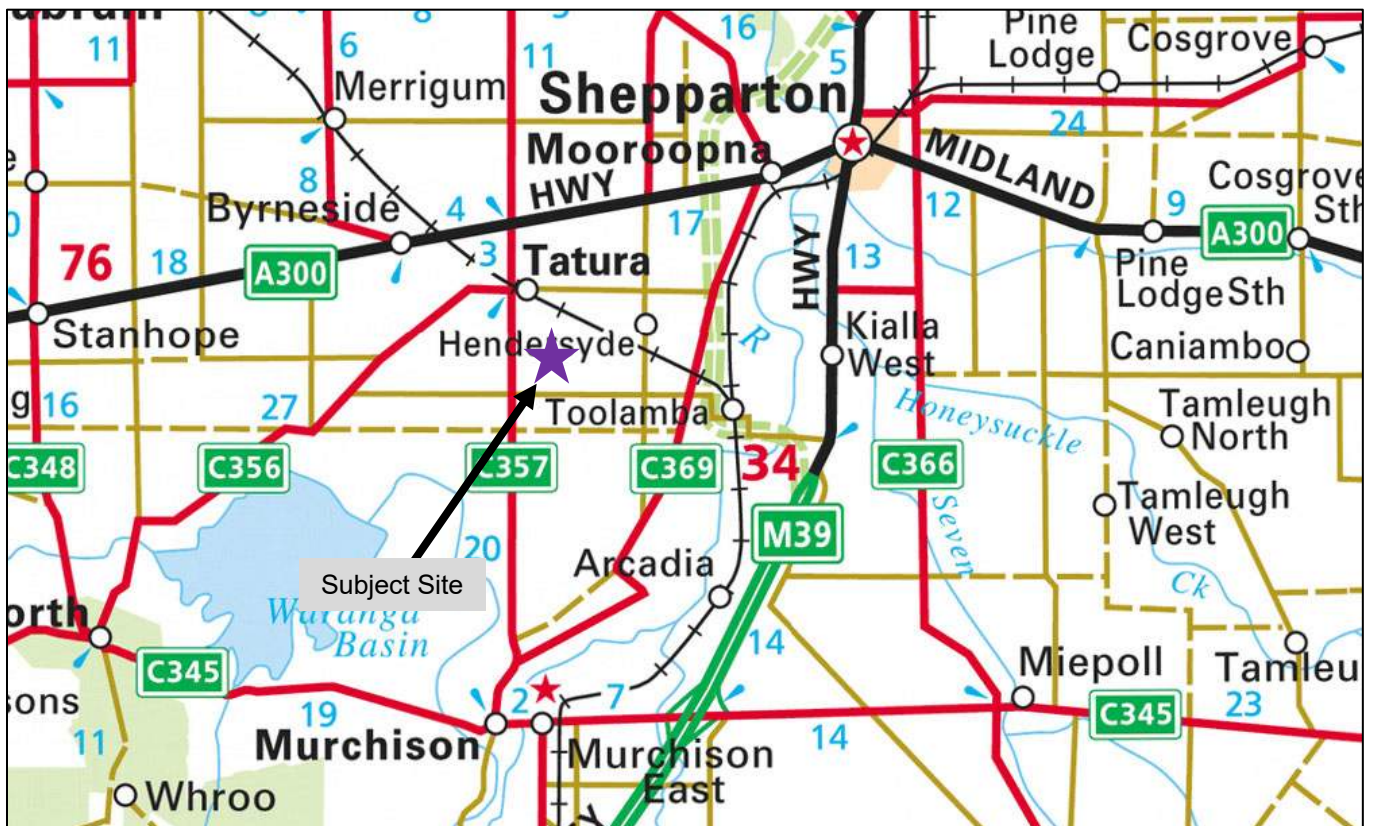

Figure 1 Subject site location

Image source: Melway Online (Date extracted: 29/11/2023)

This copied document to be made available for the sole purpose of enabling its consideration and review as part of a planning process under the Planning and Environment Act 1987. The document must not be used for any purpose which may breach any copyright

**ADVERTISED
PLAN**



Figure 2 Subject site aerial image

Image source: Nearmap – Imagery (Date captured: 07/10/2023, Date extracted: 29/11/2023)

2.2 Planning zones

It is shown in Figure 3 that the site is currently located within a Public Use Zone (PUZ1). Additionally, surrounding properties close to the subject site are mainly Farming Zone (FZ1). The purpose of this zoning is to enable land use for agriculture and to encourage the retention of productive agricultural land.

This copied document to be made available for the sole purpose of enabling its consideration and review as part of a planning process under the Planning and Environment Act 1987. The document must not be used for any purpose which may breach any copyright

**ADVERTISED
PLAN**

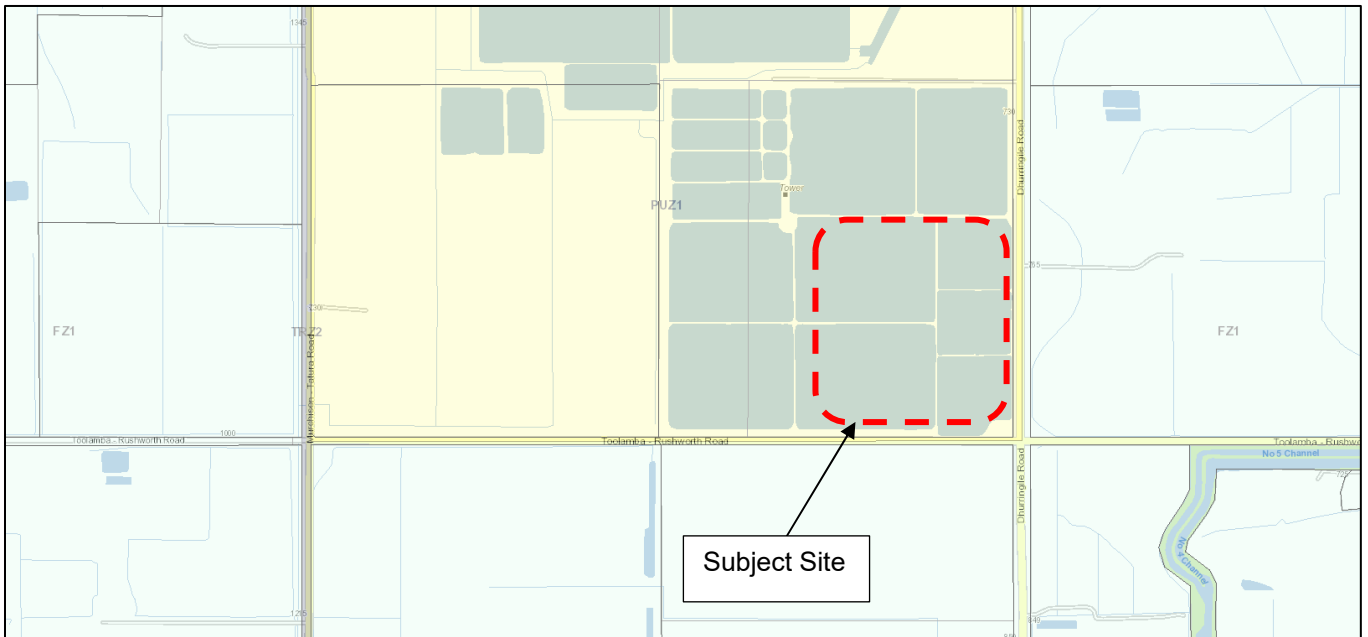

Figure 3 Planning scheme zones

Image source: VicPlan (Date extracted: 29/11/2023)

2.3 Road network

2.3.1 Dhurringile Road

Dhurringile Road is a Local Road (managed by Greater Shepparton City Council) and is aligned in a north-south direction (located to the east of the subject site).

It is generally constructed to a rural highway standard with an approximate 7 metre sealed carriageway carrying a single traffic lane in either direction as shown in Figure 4. Recent aerial image of the road indicates that road surface is typically in good condition along the length of the road and within the vicinity of the site. There are audio tactile line markings along the centre of the road.

Along the site frontage, Dhurringile Road has a default speed limit of 100 km/hr.

Footpaths are not available adjacent to Dhurringile Road.

Traffic volume data is not available for Dhurringile Road in the Department of Transport's open data hub. Considering the local distribution of traffic and surrounding rural and farming land uses, it is assumed that the traffic volumes will be low in nature with no more than 150-200 traffic movements daily in both directions.

This copied document to be made available for the sole purpose of enabling its consideration and review as part of a planning process under the Planning and Environment Act 1987. The document must not be used for any purpose which may breach any copyright

ADVERTISED PLAN



Figure 4 Dhurringile Road facing north adjacent to subject site

Image source: Google Street View (Date extracted: 29/11/2023)

2.3.2 Toolamba-Rushworth Road

Toolamba-Rushworth Road is a local road oriented generally east-west in the vicinity of the subject site providing connection between Toolamba Road 7.5 km to the east and Rushworth-Tatura Road 9 km to the west.

Adjacent to the subject site Toolamba-Rushworth Road operates as a two-way road with one lane in each direction as shown in Figure 5. Carriageway width ranges between 6 m-6.3 m and rumble strips are provided along the road for east bound traffic prior to the Toolamba-Rushworth Road/Dhurringile Road intersection to alert motorists about the upcoming intersection.

Abutting the site frontage, a default speed limit of 100 km/hr applies along Toolamba-Rushworth Road.

Footpaths are not available adjacent to Toolamba-Rushworth Road.

Traffic volume data is not available for Toolamba-Rushworth Road in the Department of Transport's Open Data Hub. Considering the local distribution of traffic and surrounding rural and farming land uses, it is assumed that the traffic volumes will be low in nature with no more than 100-200 traffic movements daily in both directions.

This copied document to be made available for the sole purpose of enabling its consideration and review as part of a planning process under the Planning and Environment Act 1987. The document must not be used for any purpose which may breach any copyright

**ADVERTISED
PLAN**



Figure 5 Toolamba-Rushworth Road facing west adjacent to subject site

Image source: Google Street View (Date extracted: 29/11/2023)

2.4 Sustainable transport

There are no public transport services available nearby the subject site. It is therefore expected that all trips to and from the proposed site would be via private vehicle.

2.5 Crash analysis

Crash data was obtained from Department of Transport and Planning's Open Data Portal website for the most recent 5-year period (2019-2023) for the roads surrounding the subject site.

A total of three crashes were reported within the vicinity of the site and all these crashes occurred at the Toolamba-Rushworth Road/Dhurringile Road intersection as shown in Figure 6. The types of those crashes ranged from "cross traffic" to "right turn" intersection crashes. One of these crashes was classed as a serious injury crash. It is understood that rumble strip treatments are implemented along Toolamba-Rushworth Road for both east and west approach of the Toolamba-Rushworth Road/Dhurringile Road intersection in response to the resulted crashes.

It is noted that no crash was recorded along Toolamba-Rushworth Road vicinity of the subject site.

This copied document to be made available for the sole purpose of enabling its consideration and review as part of a planning process under the Planning and Environment Act 1987. The document must not be used for any purpose which may breach any copyright

**ADVERTISED
PLAN**



Figure 6 Crash location surrounding subject site.

Image source: Google earth (Date extracted: 15/12/2023), Crash data source: DTP

This copied document to be made available for the sole purpose of enabling its consideration and review as part of a planning process under the Planning and Environment Act 1987. The document must not be used for any purpose which may breach any copyright

**ADVERTISED
PLAN**

3. Proposed development

3.1 General

It is proposed to develop a solar Photovoltaic (PV) generating systems on GVW owned land located adjacent to the Wastewater Management Facilities (WMF) at Tatura with project area of 170,560 m². The intent of the solar PV system is to provide GVW with maximum energy yield so that GVW can offset their carbon footprint and generate revenue by selling electricity to the market.

The project will include a solar photovoltaic (PV) generation plant, high voltage (HV) infrastructure integration and reticulation systems comprising of the following:

- Fixed tilt or Single Axis Tracking (SAT) PV arrays located within GVW land.
- Power stations comprising of inverters, transformers, ring main units, controls, communication systems, AC/DC reticulation and other balance of plant.
- Control and switching room.
- Associated civil and structural works at the Solar Farm.
- Integration into the DNSP electrical network including HV cabling, conduits, pits (a substantial portion of this being in GVW land).

The proposed Solar Farm expected to have a capacity of less than 5 MW AC, the final DC size will be depending on the equipment and configuration selected by the contractor.

The proposed development plan is shown in Figure 7 and included in Appendix A.

ADVERTISED PLAN

This copied document to be made available for the sole purpose of enabling its consideration and review as part of a planning process under the Planning and Environment Act 1987. The document must not be used for any purpose which may breach any copyright

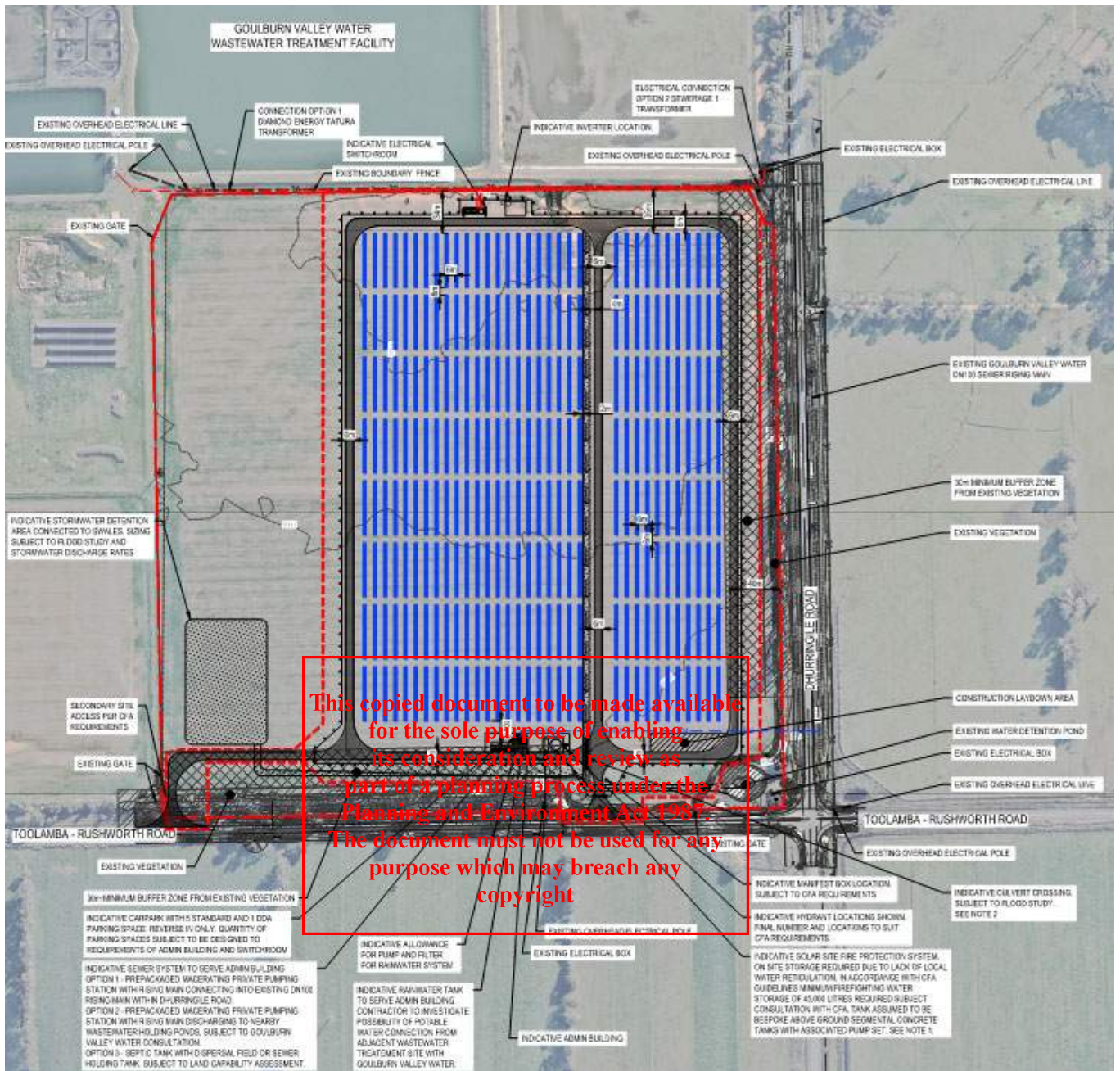

Figure 7 Proposed site layout

source: GHD, Drawing number: 12579414-GHD-00-00-DRG-CI-00100, Rev: P02, Date: 19/10/23

3.2 Site access

Site access for vehicular traffic will be provided via two proposed crossover access points. Both accesses will be located on Toolamba-Rushworth Road as shown in Figure 7.

3.3 Parking

As part of the proposal, it is proposed to provide total of six (6) on-site car parking spaces including one (1) accessible parking spaces. The car parking spaces will be located to the south of the site boundary adjacent to the administration building.

**ADVERTISED
PLAN**

This copied document to be made available for the sole purpose of enabling its consideration and review as part of a planning process under the Planning and Environment Act 1987. The document must not be used for any purpose which may breach any copyright

4. Traffic considerations

4.1 Traffic generation

4.1.1 Construction period

A detailed understanding of the expected construction traffic levels is not available at this early stage. Therefore, a previous traffic impact assessment (TIA) completed by GHD for a solar farm has been referenced to determine the expected traffic generation for the subject site. The TIA was completed for a 50-60MW solar farm project in Glenrowan West. It was estimated that the site would generate in the order of 330 vehicle movements per day during the peak of the construction period comprising:

- 300 light vehicle movements (two-way)
- 30 heavy vehicle movements (two-way).

The subject site is approximately 10% of the size of the Glenrowan solar farm site (being a facility with a 5 MW AC output). As such, it is estimated that the construction traffic would be around 10% of the traffic that the Glenrowan solar farm site was predicted to generate, which equates to in the order of 34 vehicle movements per day during the peak of the construction period including the following. It is anticipated that Solar farm components will be delivered to the site by 19m meter semi-trailers and 26m B-double trucks.

- 30 light vehicle movements per day (two-way)
- 4 heavy vehicle movements (two-way).

4.1.2 Operation period

It is expected that traffic movements would be minimal during the operation period. This would be limited to routine maintenance and emergency maintenance only, and expected to be in the order of approximately 5 vehicles per week. These movements are not considered to have any impact on the surrounding road network and as such have not been considered for further analysis.

4.2 Traffic distribution

It is anticipated that construction traffic from the Shepparton and Tatura areas would arrive at the site from the east via Toolamba-Rushworth Road, and motorists from Melbourne or Seymour would arrive at the site from the west via Toolamba-Rushworth Road. Based on the relative catchments or major towns surrounding the site, the following distributions are expected:

- Toolamba-Rushworth Road (to and from east) (e.g., Shepparton, Tatura, Benalla) 60%
- Toolamba-Rushworth Road (to and from west) (e.g., Melbourne, Seymour) 40%

In addition to above, construction traffic movements at the proposed access points along Toolamba-Rushworth Road have been estimated using the traffic distribution assumption below and illustrated in Figure 8 and Figure 9.

- Conservatively it is assumed that the majority of (around 40% of the daily traffic) the estimated daily traffic would occur during peak times (AM peak and PM peak) with 14 inbound movements during AM peak and 14 outbound movements during PM peak. The remaining 6 movements are anticipated to occur outside peak periods.
- Traffic will be evenly distributed at both two proposed accesses during the construction phase.
- 10% of the daily traffic trips along Toolamba-Rushworth Road as described in section 2.3.2 will occur during peak hour which equates to 10-15 movements (two-way movements).

**ADVERTISED
PLAN**

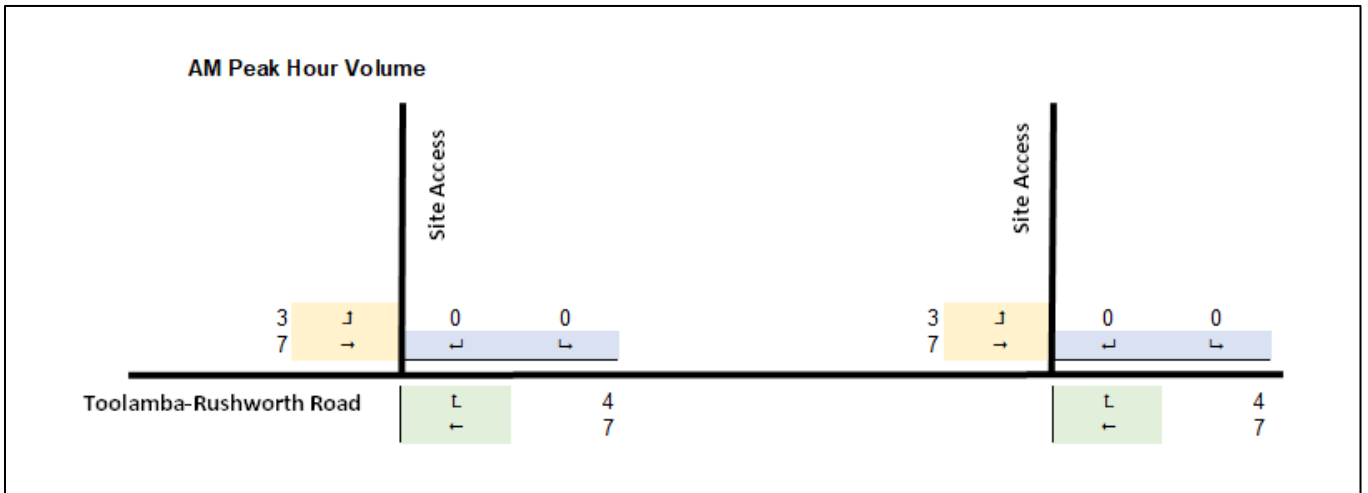

Figure 8 Anticipated AM Peak hour construction traffic movements at Toolamba-Rushworth Road and proposed Site Access intersections

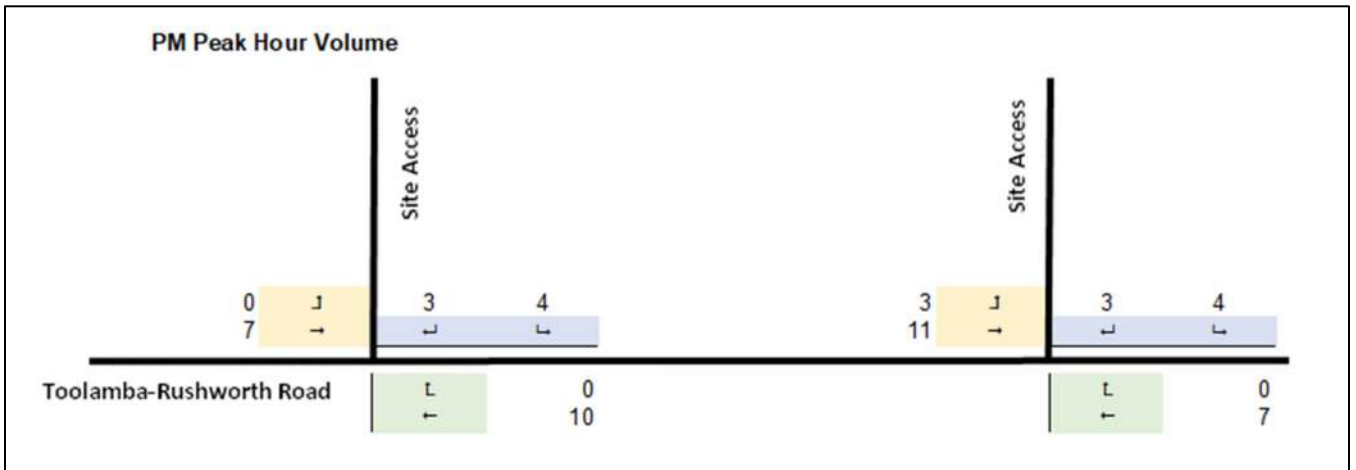

Figure 9 Anticipated PM Peak hour construction traffic movements at Toolamba-Rushworth Road and proposed Site Access intersections

4.3 Traffic impact

It is anticipated that proposed development construction will generate in the order of 34 vehicle movements per day and is expected to be distributed across the proposed two access points at Toolamba-Rushworth Road.

These numbers are considered a maximum (or “worst-case”) scenario, and on some days, traffic volumes will be considerably lower, typically when deliveries are not expected and the full complement of construction workers are not required on-site.

Peak hourly traffic estimate indicates that total peak hour movements at each access point will be in order of 7 vehicle movements, which equates to 1 vehicle movements in eight (8) to nine (9) minutes.

This level of traffic is considered to be on the low side and can be adequately accommodated within the surrounding road network capacity without causing detrimental impact to the existing traffic network.

This copied document to be made available for the sole purpose of enabling its consideration and review as part of a planning process under the Planning and Environment Act 1987. The document must not be used for any purpose which may breach any copyright

ADVERTISED PLAN

5. Design considerations

5.1 Site access

It is proposed that access to the development would be via two new crossover accesses from Toolamba-Rushworth Road. Both accesses are designed to accommodate a 26 m B-double truck movements, which is the largest vehicle anticipated to access the subject site.

In addition, the proposed internal access roads are 6m wide which exceeds the minimum 5.5 m roadway width requirement as per AS2890.1 to accommodate two-way movements.

A swept path assessment of a 26 m B-double truck's turning movement is included in Appendix B.

5.1.1 Turn lane warrant assessment

Austrroads Guide to design - Part 6 (AGTM - 2020) Section 3.3.6 provides guidance on warrants to determine the requirement for turn lane treatments at Major Road intersections.

To understand turn lane requirement for the proposed access locations at Toolamba-Rushworth Road, *figure 3.25* from AGTM Part 6 has been reviewed and applied for this project, which is applicable for design speed of ≥ 100 km/hr.

Utilising the estimated peak hour traffic flow as described in section 4.2, the outcome of the warrant assessment is illustrated in Figure 10. It is to be noted that warrant assessment only conducted for AM peak hour movements since during PM peak hour all the expected movements are outbound only.

The assessment indicates that the expected peak hourly turn volumes during construction are not expected to warrant any separate turn lane treatments to be provided along Toolamba-Rushworth Road at the proposed site access intersections. The turn volumes according to Figure 10 show requirements for Basic Right turn (BAR) and Basic Left turn (BAL) treatments which consist of shoulder widening. Given very low number of turning traffic demand and low through traffic along Toolamba-Rushworth Road, risks of conflicts between vehicle waiting to turn and through traffic are considered to be low. As such, shoulder widening (BAL and BAR) treatments are not deemed necessary.

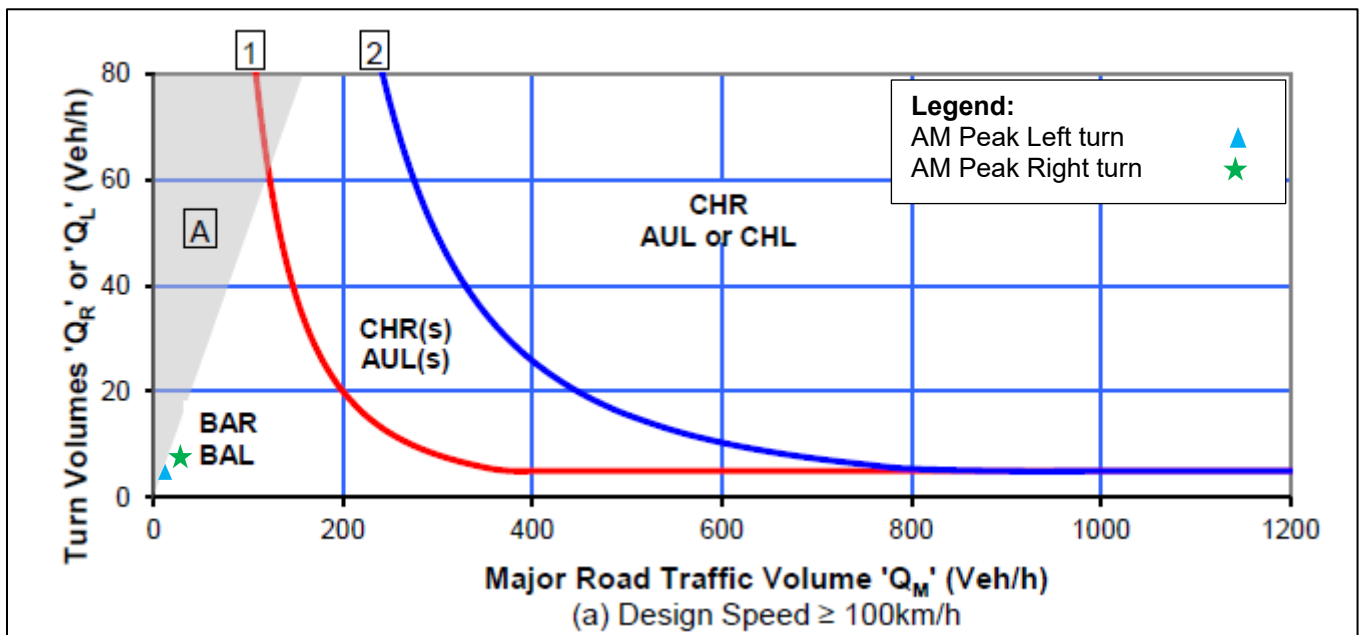

Figure 10 Turn Lane warrant assessment for construction traffic

**ADVERTISED
PLAN**

5.1.2 Sight distance assessment

The Austroads Guide to Road Design (AGRD) – Part 4A: Unsignalised and Signalised Intersections, 2023, provides the requirements of the Safe Intersection Sight Distance (SISD) in metres.

As per the table 3.2 of AGRD part 4A, for 100 km/hr considering 2 sec reaction time, the minimum SISD requirement is 248 metres.

A sight distance assessment has been completed at the proposed design and shown in Figure 11 and Figure 12. The assessment indicates that some trees may restrict required sight lines and it is recommended that these trees be trimmed (as noted in Figure 11 and Figure 12) up to 1.25 m above from the road level to ensure that adequate sight lines are available for the motorists exiting the site.

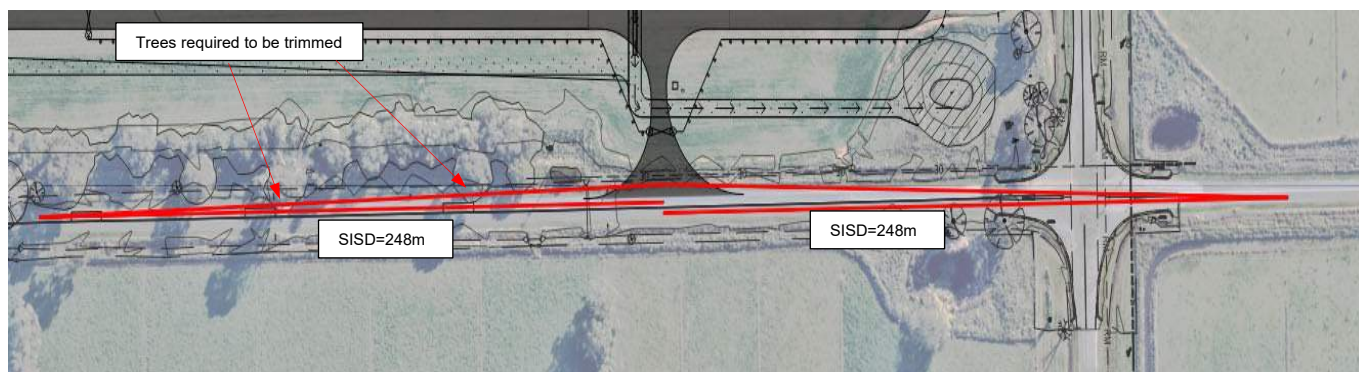

Figure 11 Sight distance assessment for east access

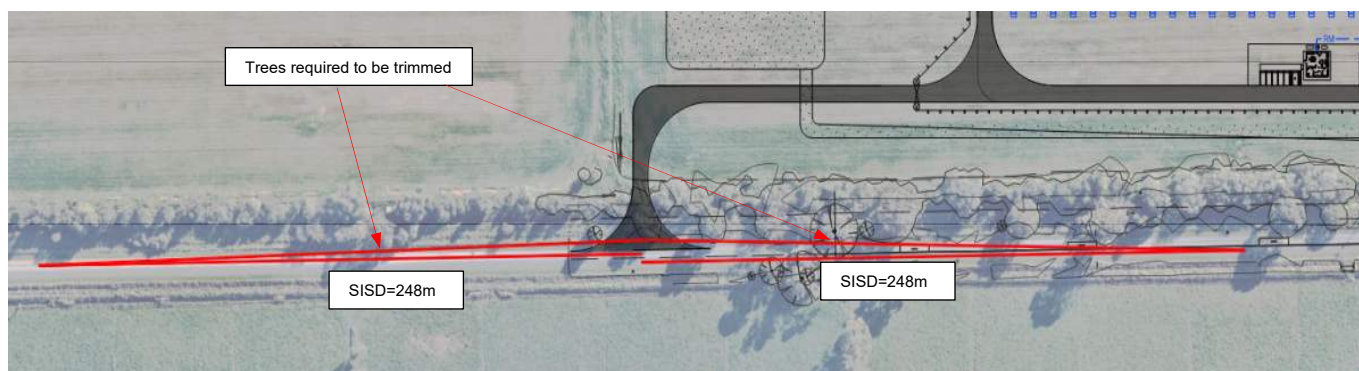

Figure 12 Sight distance assessment for west access

5.2 On-site parking

A total of six (6) on-site car parking spaces including one (1) accessible parking spaces are proposed to be provided. Given low traffic movements of approximately 5 vehicles per week during operation time, six on-site parking spaces considered satisfactory. Additionally, it is noted that the site will have available open spaces which can be used to accommodate additional on-site parking demand if required.

Table 2 of the Greater Shepparton Planning Scheme Clause 52.06-9 provides design requirements for accessway width, parking space width and length as shown in Figure 13.

This copied document to be made available for the sole purpose of enabling its consideration and review as part of a planning process under the Planning and Environment Act 1987. The document must not be used for any purpose which may breach any copyright

ADVERTISED
PLAN

Table 2: Minimum dimensions of car parking spaces and accessways			
Angle of car parking spaces to access way	Accessway width	Car space width	Car space length
Parallel	3.6 m	2.3 m	6.7 m
45°	3.5 m	2.6 m	4.9 m
60°	4.9 m	2.6 m	4.9 m
90°	6.4 m	2.6 m	4.9 m
	5.8 m	2.8 m	4.9 m
	5.2 m	3.0 m	4.9 m
	4.8 m	3.2 m	4.9 m

Figure 13 Greater Shepparton planning scheme clause 52.06-9 requirement for car parking space design

Design for proposed car parking spaces has not been finalised yet. It is recommended to design car parking spaces and accessway widths as illustrated in Figure 13 to meet the Greater Shepparton Planning Scheme Clause 52.06-9 criteria and it is considered that sufficient area is available adjacent to the proposed admin building to accommodate compliant car park design and accessway.

This copied document to be made available for the sole purpose of enabling its consideration and review as part of a planning process under the Planning and Environment Act 1987. The document must not be used for any purpose which may breach any copyright

**ADVERTISED
PLAN**

6. Major truck access routes

Two access routes have been identified for heavy vehicles as described below, which are aligned with Victoria's approved Oversize/Over mass network (OSOM):

- Route to and from east (e.g., Shepparton, Benalla): Subject site – Toolamba-Rushworth Road – Toolamba Road – Midland Highway – High Street – Benalla Road (as shown in Figure 14)
- Route to and from west (e.g., Melbourne, Seymour): Subject site – Toolamba-Rushworth Road – Murchison Tatura Road – River Road – High Road – Murchison Violet Town Road – Goulburn Valley Freeway (as shown in Figure 15)

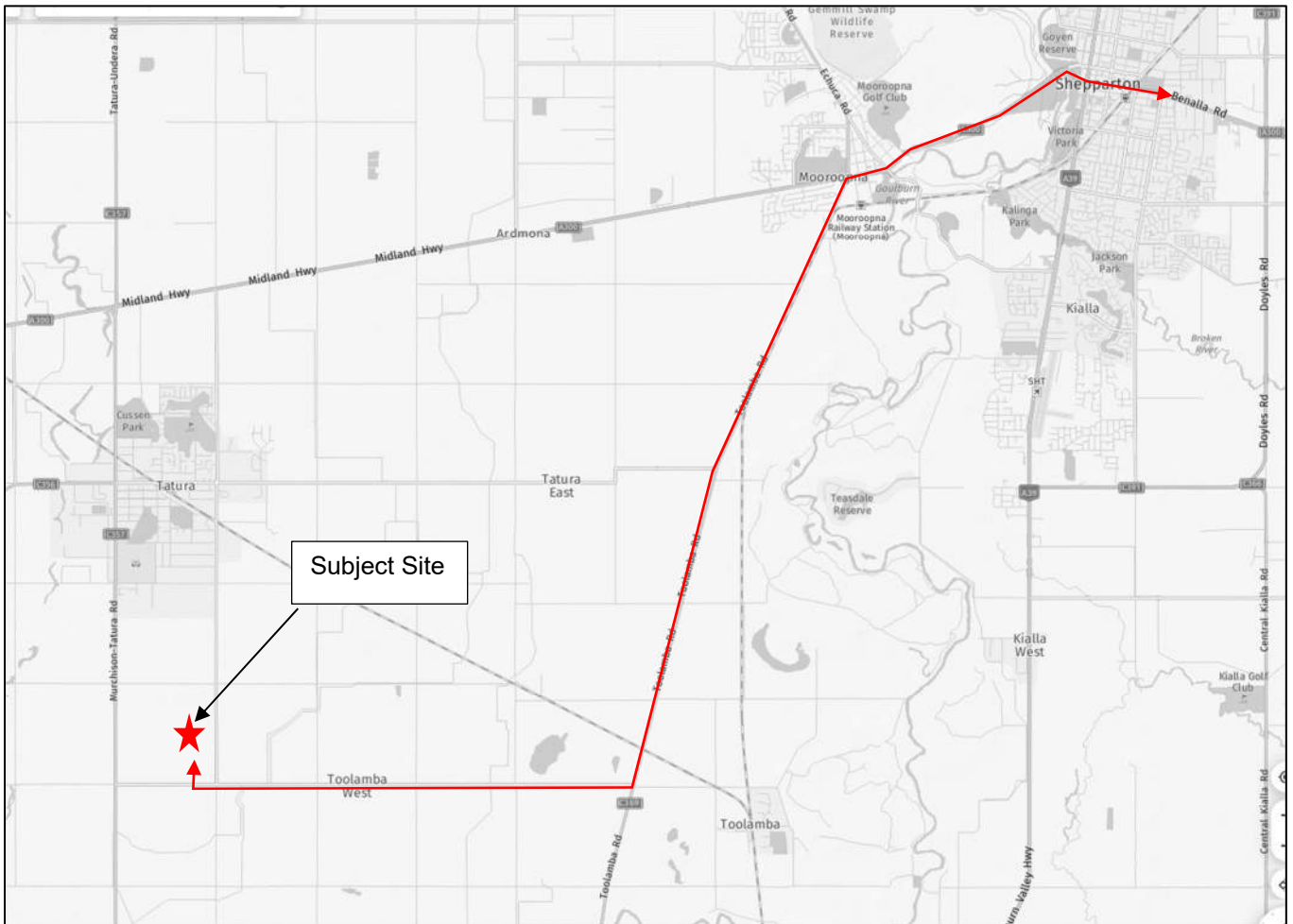

Figure 14 Truck access route to and from east

Image source: Nearmap – Imagery (Date extracted: 29/11/2023)

This copied document to be made available for the sole purpose of enabling its consideration and review as part of a planning process under the Planning and Environment Act 1987. The document must not be used for any purpose which may breach any copyright

**ADVERTISED
PLAN**

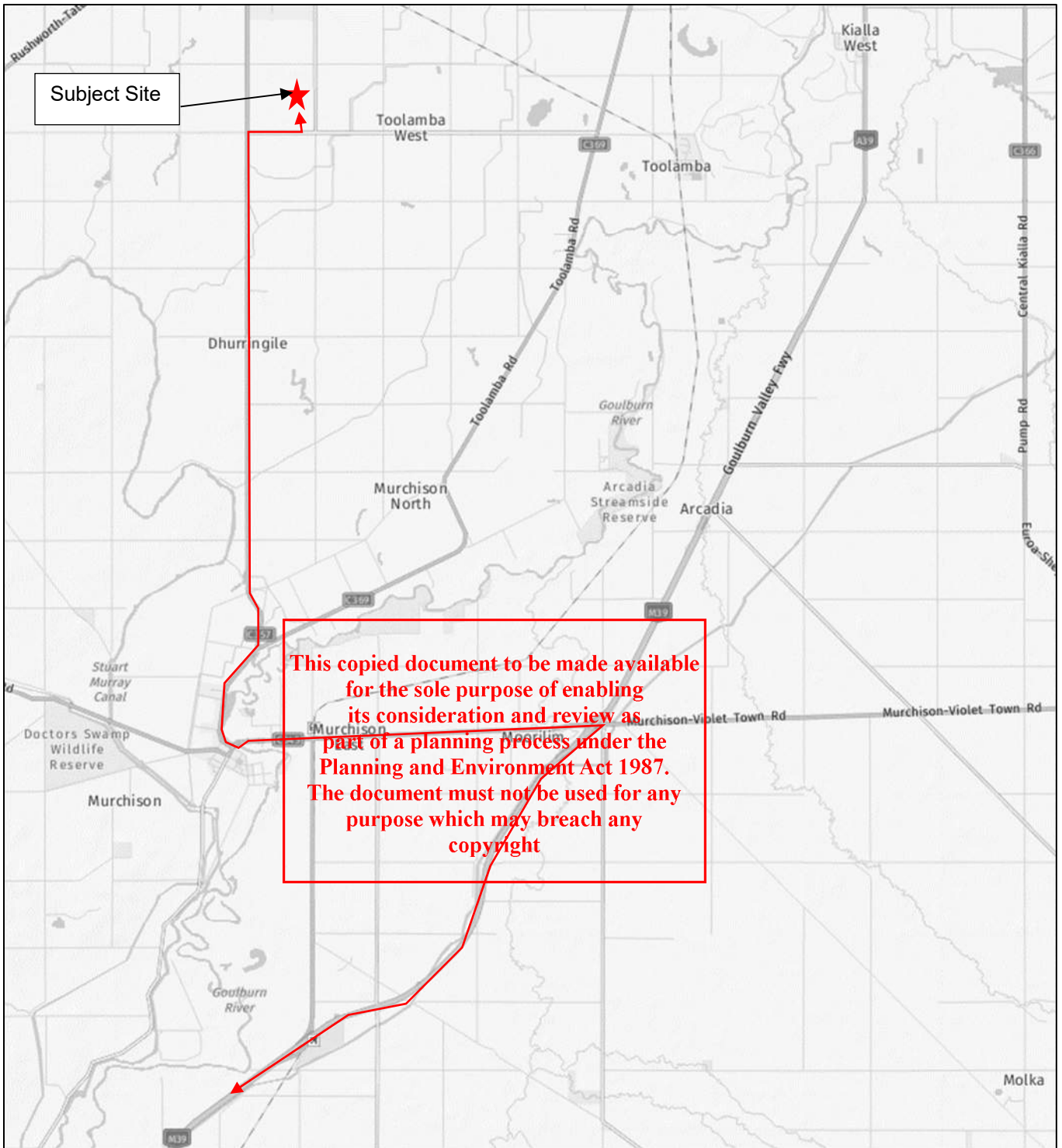

Figure 15 Truck access routes to and from west

Image source: Nearmap – Imagery (Date extracted: 29/11/2023)

The approved OSOM network surrounding the subject site is shown in Figure 16.

It is noted from Victoria’s OSOM routes that the roads along the identified routes have the following conditions:

- **High Street, Shepparton:** The rail crossing at this location is conditionally approved for vehicles up to 26 metres in length or 4.9 metres in height. Larger size vehicles would require separate approval from the Department of Transport and Planning.

ADVERTISED PLAN

- **Toolamba Road, Toolamba:** The rail crossing is conditionally approved for vehicles up to 26 metres in length or 4.9 metres in height. Larger sized vehicles would require separate approval from the Department of Transport and Planning.
- **Murchison - Violet Town Road, Murchison East:** The rail crossing is conditionally approved for vehicles up to 26 metres in length or 4.9 metres in height. Larger sized vehicles would require separate approval from the Department of Transport and Planning.
- **High Road, Murchison East:** Restricted structure - Structure SN4879 has a 49.5 tonne mass limit restricting access for vehicles heavier than this limit.

If an over-dimensioned load needs to be carried to the project site, it would require a permit from the National Heavy Vehicle Registration (NHVR) to travel through the Victoria region. The haulage contractor would ultimately be responsible for obtaining and complying with required the permit for each over-dimensioned load to be transported to the project area.

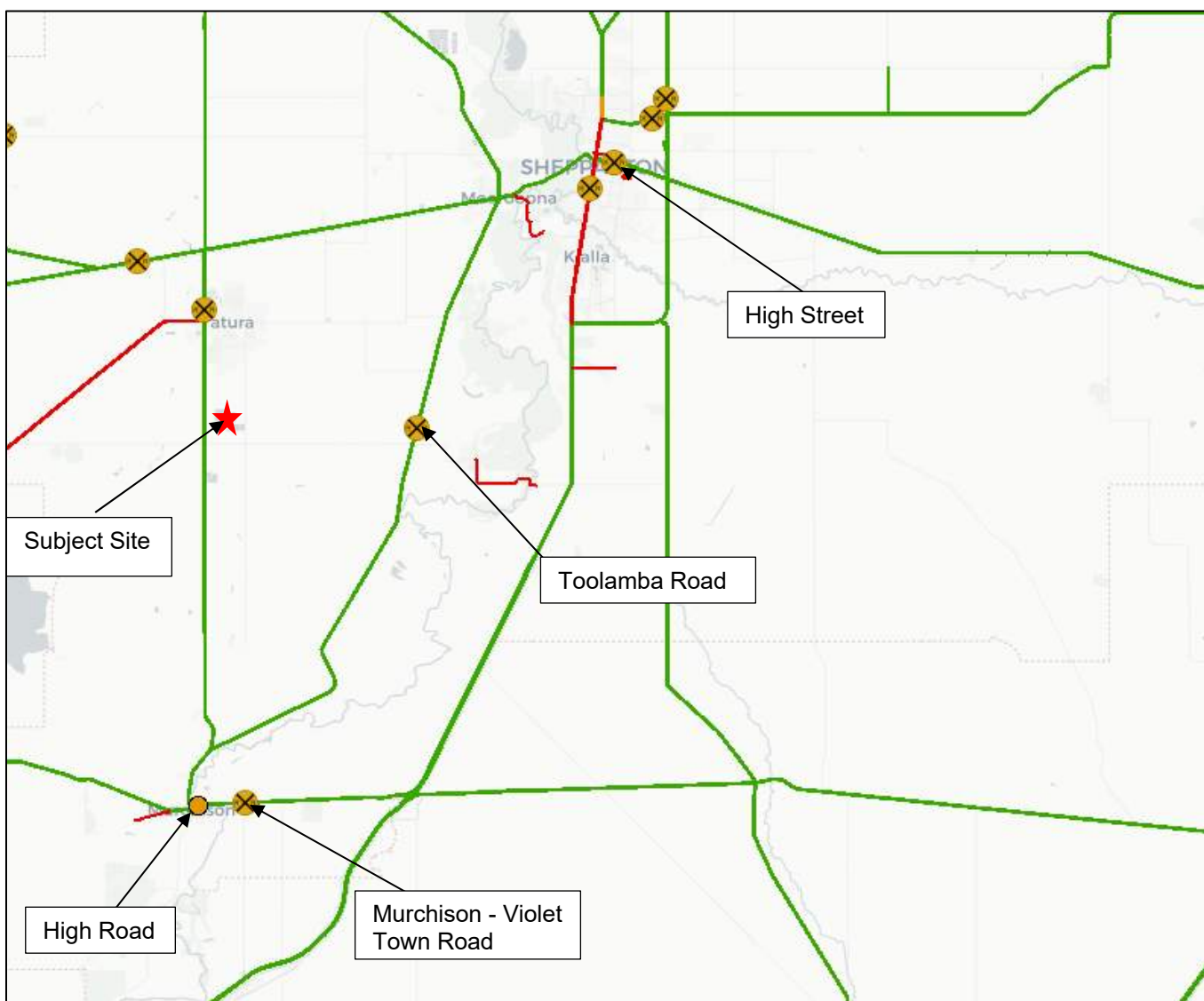

Figure 16 OSOM map surrounding subject site

source: NHVR website (Date extracted: 01/12/2023)

This copied document to be made available for the sole purpose of enabling its consideration and review as part of a planning process under the Planning and Environment Act 1987. The document must not be used for any purpose which may breach any copyright

ADVERTISED PLAN

7. Conclusions

Based on the foregoing analysis, it is concluded that:

- The proposed Solar Farm would be located on Toolamba-Rushworth Road approximately 5 kilometres to the south of Tatura and it will have a capacity of less than 5 MW AC.
- Access to the development would be provided from Toolamba-Rushworth Road via two crossover access points.
- Access crossovers and internal access roads (from the access way to the laydown area) are designed to accommodate 26 m B-double truck's turning movement.
- The proposed development is expected to generate up to 34 daily traffic movements and 14 peak hour movements during peak construction periods.
- Turn lane warrant assessment as per AGTM part 6 indicates that the expected peak hourly turn volumes are not expected to warrant any separate turn lane treatments to be provided along Toolamba-Rushworth Road at the proposed site access intersections.
- Sight distance assessment indicates that some trees would need to be trimmed up to 1.25 m above from the road level to ensure that adequate sight lines are available for the motorists exiting the site.
- It is recommended to design car parking spaces and accessway width to meet Greater Shepparton planning scheme clause 52.06-9 criteria as described under section 5.2.
- The projected traffic increase during construction period is considered to be on the low side and can be adequately and safely accommodated within the surrounding road network without causing detrimental impact.

ADVERTISED PLAN

**This copied document to be made available
for the sole purpose of enabling
its consideration and review as
part of a planning process under the
Planning and Environment Act 1987.
The document must not be used for any
purpose which may breach any
copyright**

Appendices

**ADVERTISED
PLAN**

**This copied document to be made available
for the sole purpose of enabling
its consideration and review as
part of a planning process under the
Planning and Environment Act 1987.
The document must not be used for any
purpose which may breach any
copyright**

Appendix A

Development Plan

This copied document to be made available for the sole purpose of enabling its consideration and review as part of a planning process under the Planning and Environment Act 1987. The document must not be used for any purpose which may breach any copyright

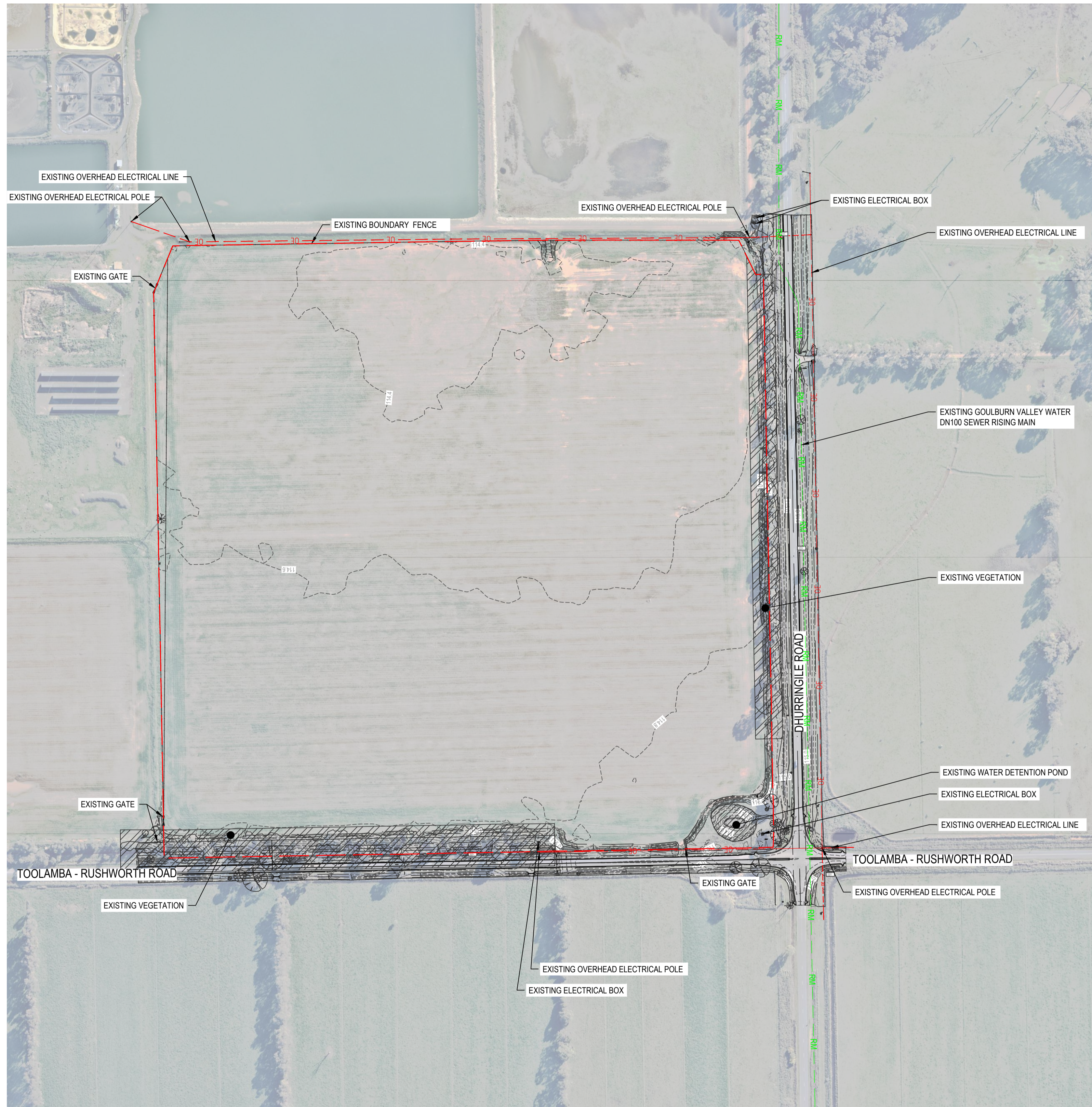

LEGEND

- — — — — SITE BOUNDARY (AREA = 245,745 m²)
- EXISTING POND
- EXISTING VEGETATION
- EXISTING FENCE
- EXISTING MAJOR CONTOURS
- EXISTING MINOR CONTOURS
- EXISTING OVERHEAD ELECTRICAL POST
- EXISTING GATE
- E — — — — — PROPOSED ELECTRICAL LINES
- RM — — — — — PROPOSED SEWER RISING MAIN

NOTES:

1. SITE AREA UNDERSTOOD TO BE PREVIOUSLY USED AS LINED EVAPORATION AN FOR POST-TREATMENT WASTEWATER EVAPORATION.

This copied document to be made available for the sole purpose of enabling its consideration and review as part of a planning process under the Planning and Environment Act 1987. The document must not be used for any purpose which may breach any copyright

ADVERTISED PLAN

PLAN
SCALE 1:2000

P02	CONCEPT DESIGN	M.G.	A.V.	19.10.23
P01	DRAFT CONCEPT DESIGN	M.G.	A.V.	10.10.23
Rev	Description	Checked	Approved	Date
Author	M. PAÑA	Drafting Check	D. KOKOTOVIC	
Designer	M. JARING	Design Check	M. GOODE	

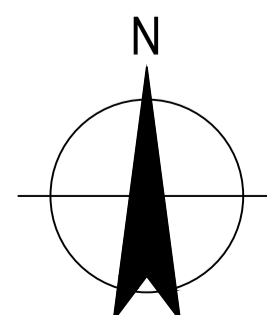

GHD

Level 9, 180 Lonsdale Street,
Melbourne VIC 3000 Australia
T 61 3 9687 8000 F 61 3 9687 8111
E mel@mail@ghd.com W www.ghd.com



Client **GOULBURN VALLEY WATER**

Project **GVW SOLAR FARM**

Status **IN DEVELOPMENT**

Drawing Title **TATURA
EXISTING CONDITIONS PLAN**

Size **A1**

Drawing No. **12579414-GHD-00-00-DRG-CI-00010** Rev **P02**

ADVERTISED PLAN

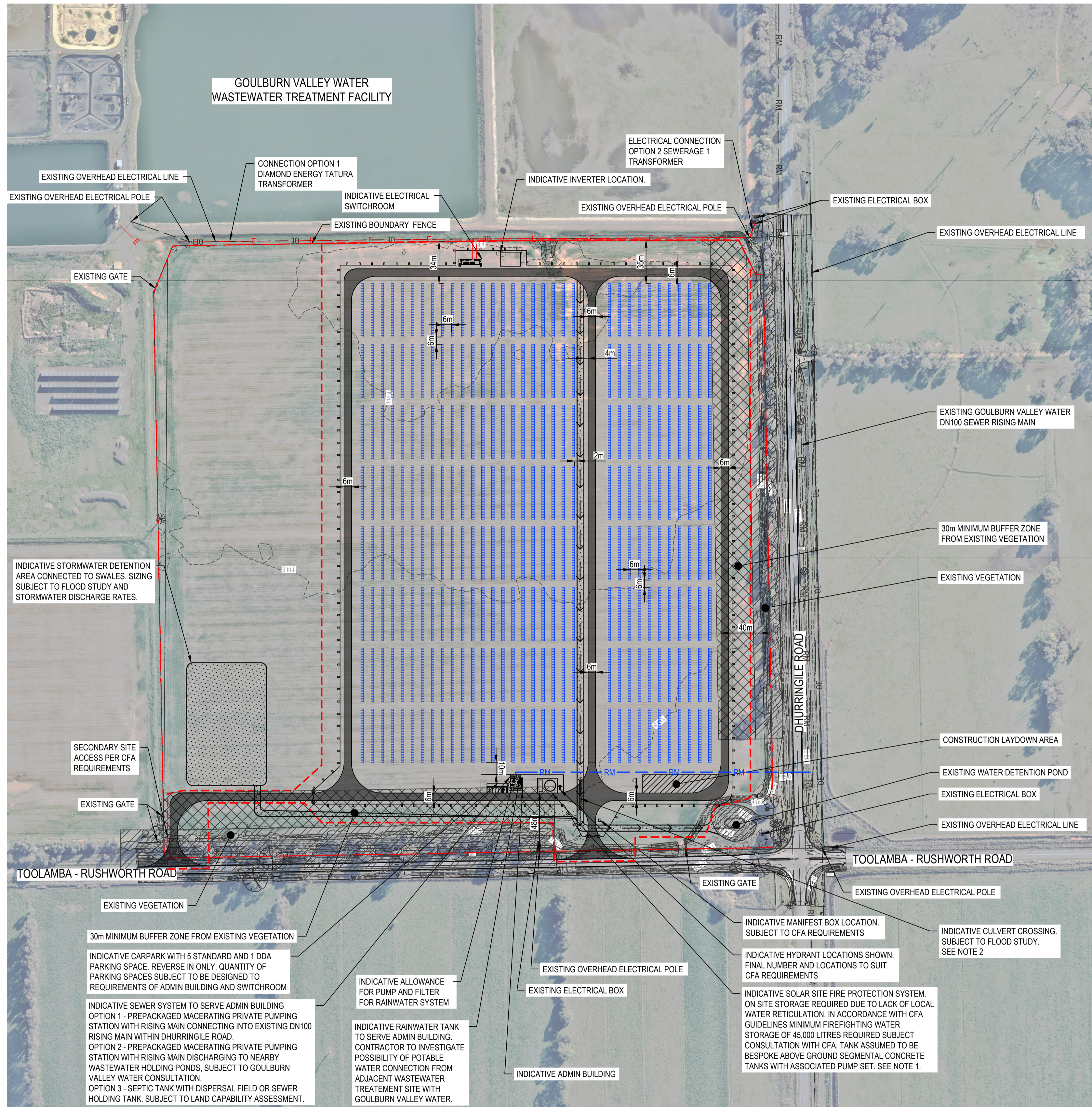

PLAN
SCALE 1:2000

LEGEND

- SITE BOUNDARY (AREA = 245,745 m²)
- EXTENT OF WORKS / PROJECT AREA (AREA = 170,560 m²)
- 30m VEGETATION BUFFER ZONE
- EXISTING POND
- EXISTING VEGETATION
- EXISTING FENCE
- EXISTING MAJOR CONTOURS
- EXISTING MINOR CONTOURS
- EXISTING OVERHEAD ELECTRICAL POST
- EXISTING GATE
- PROPOSED GATE
- PROPOSED FENCE
- INDICATIVE SOLAR PANEL
- INDICATIVE INVERTER
- PROPOSED SWALE
- PROPOSED HYDRANT
- PROPOSED UNSEALED ROADS
- PROPOSED ELECTRICAL LINES
- PROPOSED SEWER RISING MAIN
- EXISTING OVERHEAD ELECTRICITY
- EXISTING SEWER RISING MAIN

This copied document to be made available for the sole purpose of enabling its consideration and review as part of a planning process under the Planning and Environment Act 1987. The document must not be used for any purpose which may breach any copyright

NOTES:

1. REFERENCE CFA GUIDELINES "DESIGN GUIDELINES AND MODEL REQUIREMENTS - RENEWABLE ENERGY FACILITIES V4.
2. CONTRACTOR TO INCLUDE CULVERTS FOR 10% AEP FOR DRAIN CROSSINGS.

P02	CONCEPT DESIGN	M.G.	A.V.	19.10.23
P01	DRAFT CONCEPT DESIGN	M.G.	A.V.	10.10.23
Rev	Description	Checked	Approved	Date
Author	M. PAÑA	Drafting Check	D. KOKOTOVIC	
Designer	M. JARING	Design Check	M. GOODE	

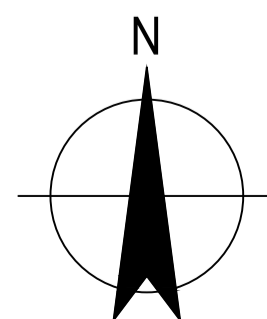

GHD
Level 9, 180 Lonsdale Street,
Melbourne VIC 3000 Australia
T 61 3 9687 6000 F 61 3 9687 8111
E mel@mail@ghd.com W www.ghd.com



Client **GOULBURN VALLEY WATER**
Project **GVW SOLAR FARM**
Status **IN DEVELOPMENT**

Drawing Title **TATURA
SITE LAYOUT PLAN**

Drawing No. **12579414-GHD-00-00-DRG-CI-00100**

Size **A1**

Rev **P02**

Appendix B

Swept Path Assessment

This copied document to be made available for the sole purpose of enabling its consideration and review as part of a planning process under the Planning and Environment Act 1987. The document must not be used for any purpose which may breach any copyright

ADVERTISED
PLAN

This copied document to be made available for the sole purpose of enabling its consideration and review as part of a planning process under the Planning and Environment Act 1987. The document must not be used for any purpose which may breach any copyright

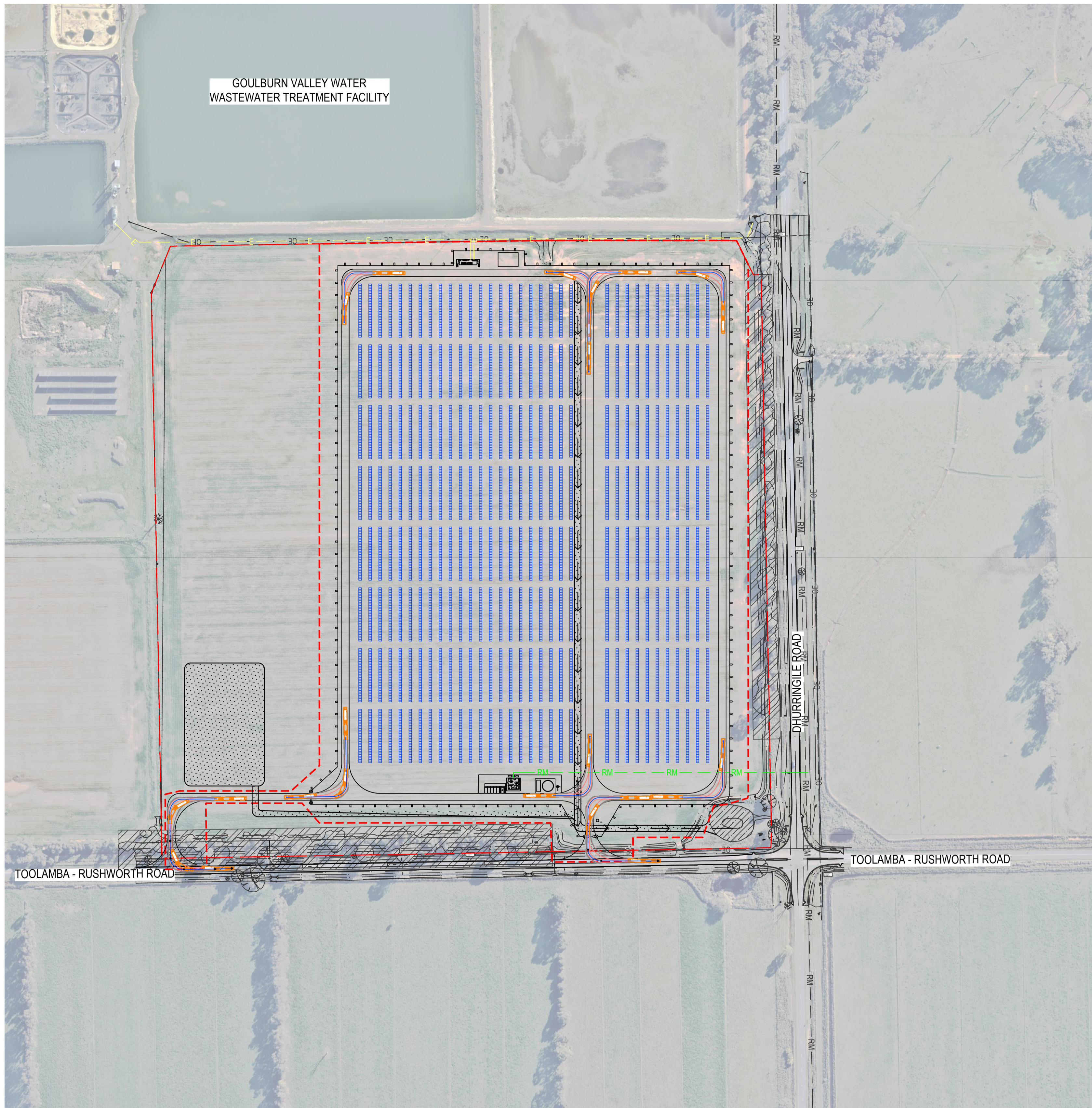

ADVERTISED PLAN

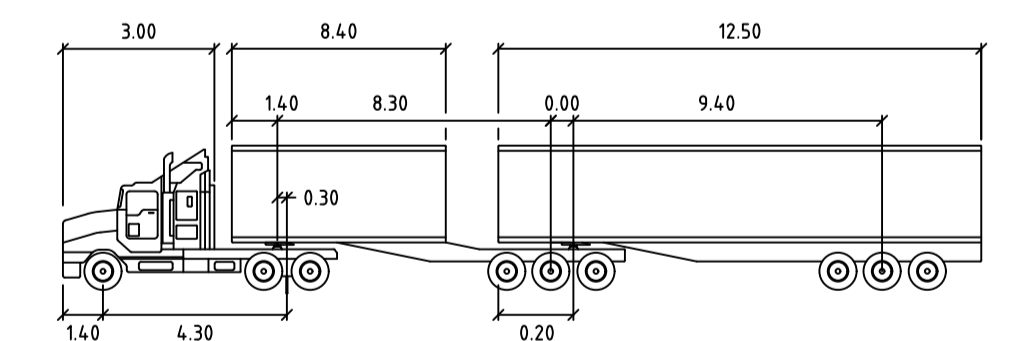

B-DOUBLE 26M

meters	
Tractor Width	: 2.50
Trailer Width	: 2.50
Tractor Track	: 2.50
Trailer Track	: 2.50
Lock to Lock Time	: 6.0
Steering Angle	: 22.2
Articulating Angle	: 70.0

PLAN
SCALE 1:2000



WARNING
SERVICES SHOWN ON THIS DRAWING ARE APPROXIMATE ONLY. THE EXACT LOCATION IS TO BE CONFIRMED ON SITE BY CONTRACTOR PRIOR TO COMMENCEMENT OF WORKS.

Rev	Description	Checked	Approved	Date
P01	DRAFT CONCEPT DESIGN	M.G.	A.V.	19.10.23
Author	M. PAÑA	Drafting Check	D. KOKOTOVIC	
Designer	M. JARING	Design Check	M. GOODE	

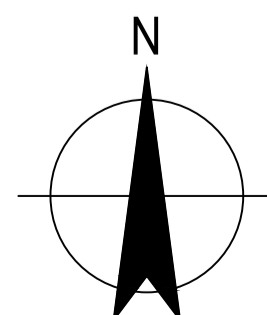
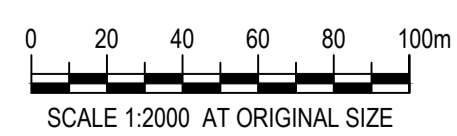

GHD
Level 9, 180 Lonsdale Street,
Melbourne VIC 3000 Australia
T 61 3 9687 8000 F 61 3 9687 8111
E mel@mail@ghd.com W www.ghd.com



Project No.
12579414

Client **GOULBURN VALLEY WATER**
Project **GVW SOLAR FARM**
Status **IN DEVELOPMENT**

Drawing Title
**TATURA
SWEEP PATH PLAN**

12579414-GHD-00-00-DRG-CI-00300

Size
A1

Rev
P01



This copied document to be made available
for the sole purpose of enabling
its consideration and review as
part of a planning process under the
Planning and Environment Act 1987.
The document must not be used for any
purpose which may breach any
copyright

Appendix D

Solar Glare Assessment

This copied document to be made available for the sole purpose of enabling its consideration and review as part of a planning process under the Planning and Environment Act 1987. The document must not be used for any purpose which may breach any copyright

ADVERTISED
PLAN



**ADVERTISED
PLAN**

Goulburn Valley Water Solar Farm – Tatura Glare Assessment Report

Goulburn Valley Water

08 March 2024



This copied document to be made available for the sole purpose of enabling its consideration and review as part of a planning process under the Planning and Environment Act 1987. The document must not be used for any purpose which may breach any copyright

→ The Power of Commitment



**This copied document to be made available
for the sole purpose of enabling
its consideration and review as
part of a planning process under the
Planning and Environment Act 1987.
The document must not be used for any
purpose which may breach any
copyright**

ADVERTISED PLAN

Project name		Goulburn Valley Water Solar Farms					
Document title		Goulburn Valley Water Solar Farm – Tatura Glare Assessment Report					
Project number		12579414					
File name		12579414-RPT_Goulburn Valley Solar Farms Tatura Solar Glare Assessment Report.docx					
Status Code	Revision	Author	Reviewer		Approved for issue		
			Name	Signature	Name	Signature	Date
S4	0	Linda Xu Anto Jose	A. Jose		M. Goode		8/03/24

GHD Pty Ltd | ABN 39 008 488 373

180 Lonsdale Street, Level 9

Melbourne, Victoria 3000, Australia

T +61 3 8687 8000 | F +61 3 8732 7046 | E melmail@ghd.com | ghd.com

© GHD 2024

This document is and shall remain the property of GHD. The document may only be used for the purpose for which it was commissioned and in accordance with the Terms of Engagement for the commission. Unauthorised use of this document in any form whatsoever is prohibited.

Executive summary

This report is subject to, and must be read in conjunction with, the limitations set out in sections 1.3 and 1.4 and the assumptions and qualifications contained throughout the Report.

Goulburn Valley Water (GVW) is seeking to install large-scale photovoltaic (PV) solar facilities within its Tatura and Seymour waste management facilities, both situated on GVW-owned land. The aim is to maximise energy yield in order to offset GVW's carbon footprint, as well as to generate revenue by selling exported electricity generated on-site to the electricity market. GHD anticipates the potential PV system sizes to meet the targeted annual electricity generation to be approximately 3 to 15 MW.

This report details the results of a comprehensive glare impact assessment conducted by GHD on the Tatura site, specific to the chosen photovoltaic (PV) solution. This assessment focuses on potential repercussions on aviation operations related to Shepparton Airport, located approximately 15 kilometres aerial distance from the proposed PV site, encompassing an examination of runway approach trajectories. Furthermore, it extends to analysing potential effects on adjacent receptors, such as road users and the local community.

Key findings

The table below summarises the predicted annual glare at the various route receptors, observer points and flight paths in the vicinity of the proposed solar facility at Tatura.

	Red Glare	Yellow Glare	Green Glare
Flight Paths	0	0	263 minutes (4.4 hours)
Route Receptors	0	975 minutes (16.2 hours)	332 minutes (5.5 hours)
Observer Points	0	0	318 minutes (5.3 hours)

Red Glare – Potential for permanent eye damage (retinal burn)
Yellow Glare – Potential for after-image
Green Glare – Low potential for after-image

No red glare is predicted to occur at any point within the vicinity of the proposed Tatura solar facility.

A small amount of yellow glare is expected to occur between 6:00 am to 8:00 am and 5:00 pm to 6:00 pm throughout the months between Autumn and Spring along the Toolamba-Rushworth Road running along the south edge of the solar facility. The level of irradiance of the predicted glare relative to the subtended source angle at the above-mentioned locations is relatively low and borderline classified as 'yellow glare'. Mitigation measures have been suggested to reduce the impact of the glare on road users and property owners, however the risk of developing after-image due to the glare is relatively low.

Green glare is predicted to occur across one of the flight paths at Shepparton Airport, along the Toolamba-Rushworth route, and at one of the observer points adjacent to the proposed facility. The green glare is predicted to occur either in the early morning or evening hours depending on the time of year, however there is low potential for after-image developing, and thus green glare is not perceived as a risk requiring any mitigation strategies.

This copied document to be made available for the sole purpose of enabling its consideration and review as part of a planning process under the Planning and Environment Act 1987. The document must not be used for any purpose which may breach any copyright

**ADVERTISED
PLAN**

Contents

Abbreviations	iv
1. Introduction	1
1.1 Project overview	1
1.2 Purpose	1
1.3 Scope and limitations	1
1.4 Assumptions	2
1.5 ForgeSolar SGHAT software overview	2
1.5.1 Glare assessment parameters	2
1.5.2 Limitations	3
2. Glare principles	4
2.1 Angle of incidence and reflection	4
2.2 Direct normal irradiance	5
2.3 Glare ocular impact categories	5
2.4 Scale of glare effects	5
2.5 Intensity	6
3. Methodology	7
3.1 Aviation impact assessment	7
3.2 Road users impact assessment	7
3.3 Community users impact assessment	7
3.4 Hierarchy of controls	7
4. Modelling	9
4.1 Design parameters	9
4.2 Flight path receptors	10
4.3 Route receptors	12
4.4 Observer points	14
5. Results	16
5.1 Summary	16
5.2 Shepparton Airport receptors	16
5.3 Route receptors	17
5.4 Observer point receptors	17
6. Conclusion and recommendations	19

**ADVERTISED
PLAN**

This copied document to be made available for the sole purpose of enabling its consideration and review as part of a planning process under the Planning and Environment Act 1987. The document must not be used for any purpose which may breach any copyright

Table index

Table 1	Tatura site solar farm parameters	9
Table 2	Tatura site boundary parameters	10
Table 3	Flight path details	12
Table 4	Flight path receptors parameters	12
Table 5	Route receptors parameters	13

Table 6	Discrete observation point receptors	14
Table 7	Potential total annual glare duration	16
Table 8	ForgeSolar Results	18
Table 9	Summary of receptors and observer points impacted by glare	19

Figure index

Figure 1	Project location	1
Figure 2	Angle of incidence and panel reflectance (Yellowhair, 2015)	4
Figure 3	Specular and diffuse reflection	4
Figure 4	Ocular impact categories (Ho, 2011)	5
Figure 5	The Hierarchy of Controls	7
Figure 6	Concept site layout	9
Figure 7	Indicative cross-section of single-axis solar tracker mounting structure	10
Figure 8	Shepparton Airport location	11
Figure 9	Aerial view of Shepparton Airport	11
Figure 10	Shepparton Airport two-mile runway and flight path	12
Figure 11	Route receptors and observation points	13
Figure 12	Predicted glare for Flight Path 2 (Runway 18) receptors for Shepparton Airport	17
Figure 13	Predicted glare for Route 2 along Toolamba-Rushworth Road	17
Figure 14	Predicted glare for OP 1 (Observer Point 1)	18
Figure 15	Areas impacted by yellow glare	19

Appendices

Appendix A	ForgeSolar Aviation Report (FAA 2021)
Appendix B	ForgeSolar Aviation Report (FAA 2013)
Appendix C	ForgeSolar Complete Analysis Report

**ADVERTISED
PLAN**

This copied document to be made available for the sole purpose of enabling its consideration and review as part of a planning process under the Planning and Environment Act 1987. The document must not be used for any purpose which may breach any copyright

Abbreviations

Abbreviation	Definition
ARC	Anti-reflective Coating
ATCT	Air Traffic Control Tower
CASA	Civil Aviation Safety Authority
DNI	Direct Normal Irradiance
FAA	American Federal Aviation Administration
hrs	Hours
HV	Heavy Vehicle
km	Kilometre
LV	Light Vehicle
MW	Mega Watt
MWp	Mega Watts Peak
min	Minutes
OP	Observation Point
PV	Photovoltaic
SAT	Single Axis Tracking
SGHAT	Solar Glare Hazard Analysis Tool
W/cm ²	Watts per square centimetre
W/m ²	Watts per square metre

This copied document to be made available for the sole purpose of enabling its consideration and review as part of a planning process under the Planning and Environment Act 1987. The document must not be used for any purpose which may breach any copyright

**ADVERTISED
PLAN**

1. Introduction

1.1 Project overview

Goulburn Valley Water (GVW) is seeking to install large-scale solar facilities within its Waste Management Facility (WMF) sites. The proposed solar site at the Tatura WMF is located at the intersection of Toolamba-Rushworth Road and Dhurringile Road in Tatura, in the Goulburn Valley region of Victoria, shown in Figure 1. The site is a decommissioned drying pan, which was previously used as part of the wastewater treatment process.



GHD Pty Ltd (GHD) has been engaged by GVW to undertake a solar glare assessment for the proposed 5.23 MWp solar farm with single-axis trackers (SAT).

1.2 Purpose

This report provides the methodology of the glare study conducted with the Solar Glare Hazard Analysis Tool (SGHAT), and lists the assumptions and parameters used and details the results and conclusions made.

1.3 Scope and limitations

This report: has been prepared by GHD for Goulburn Valley Water and may only be used and relied on by Goulburn Valley Water for the purpose agreed between GHD and Goulburn Valley Water as set out in section 1.2 of this report.

GHD otherwise disclaims responsibility to any person other than Goulburn Valley Water arising in connection with this report. GHD also excludes implied warranties and conditions, to the extent legally permissible.

The services undertaken by GHD in connection with preparing this report were limited to those specifically detailed in the report and are subject to the scope limitations set out in the report.

The opinions, conclusions and any recommendations in this report are based on conditions encountered and information reviewed at the date of preparation of the report. GHD has no responsibility or obligation to update this report to account for events or changes occurring subsequent to the date that the report was prepared.

The opinions, conclusions and any recommendations in this report are based on assumptions made by GHD described in this report (refer section 1.2 of this report). GHD disclaims liability arising from any of the assumptions being incorrect.

Accessibility of documents

If this report is required to be accessible in any other format, this can be provided by GHD upon request and at an additional cost if necessary.

1.4 Assumptions

The glare assessment was conducted with the following assumptions:

- Glare is assessed by a desktop study using industry leading software named ForgeSolar.
- The design parameters and location details were taken from concept designs for the Goulburn Valley Water Solar Farm project.
- The preliminary receptors were selected based on the site proximity to the receptors and were based on aerial observation of surrounding area.
- Publicly available information is used for the modelling of runway flight paths.
- Assessment was conducted considering single-axis tracking modules with tracking-axis along north to south, and maximum tracking angle of 60°.
- A maximum panel height of 1.6 m above ground is considered for assessing worst case glare effect scenario.
- A viewing height of 1.76 m was used, which is within the average typical viewing level range of an adult in Australia.
- The modelling only considered the landform and did not include land cover factors such as presence of buildings, trees, or screening. However, this represents the worst-case scenario for the potential glare.
- Times are given in standard time and unadjusted for daylight savings.

1.5 ForgeSolar SGHAT software overview

NOTE: While there are more sophisticated methods for calculating glare more accurately, ForgeSolar SGHAT is the only platform specifically intended for evaluating the impact of hazardous solar glare, reflected by solar panels, on the aviation industry.

Licensed from Sandia National Laboratories and provided by ForgeSolar, SGHAT is an industry-standard technical modelling tool. SGHAT can also be used to determine the impact of glare on aeroplane pilots, air-traffic controllers, pedestrians, motorists, and train drivers. SGHAT calculates the sun position and sunlight intensity at 1-minute intervals specific to location data, time of day, and time of year to determine the direction and intensity of the glare.

1.5.1 Glare assessment parameters

The ForgeSolar SGHAT can account for the following factors:

- The tilt, orientation, optical properties, and elevation of the solar panels in the solar farm.
- The sun position with respect to geographic location, elevation, time of year and time of day
- The location of sensitive receptors (viewers) and their elevation

ForgeSolar SGHAT uses the following assumptions for evaluation:

- Clear atmospheric conditions are assumed as this will present the strongest conditions for glare, therefore the effect of clouds and dust will not be included.
- There is no shading by native vegetation.
- The Google Earth topography database, which is used to determine elevation specific to location data, is accurate.

This copied document to be made available for the sole purpose of enabling its consideration and review as part of a planning process under the Planning and Environment Act 1987. The document must not be used for any purpose which may breach any copyright

**ADVERTISED
PLAN**

1.5.2 Limitations

ForgeSolar SGHAT is limited by the following:

- The algorithm does not rigorously represent the detailed geometry of a system; including features such as gaps between modules, variable height of the PV array, and support structures which may impact actual glare results.
- It is only capable of assessing the glare of an array in a single orientation.
- Random number computations are utilised by various steps of the annual hazard analysis algorithm. Predicted minutes of glare can vary between runs as a result.
- The algorithm assumes that the PV array is aligned with a plane defined by the approximate total heights of the PV vertices.
- The algorithm does not consider obstacles (either man-made or natural) between the observation points and the prescribed solar installation that may obstruct observed glare, such as trees, hills, buildings, etc.
- The variable direct normal irradiance (DNI) feature (if selected) scales the user-prescribed peak DNI using a typical clear-day irradiance profile. This profile has a lower DNI in the mornings and evenings and a maximum at solar noon. The scaling uses a clear-day irradiance profile based on a normalized time relative to sunrise, solar noon, and sunset, which are prescribed by a sun-position algorithm and the latitude and longitude obtained from Google maps. The actual DNI on any given day can be affected by cloud cover, atmospheric attenuation, and other environmental factors.
- The ocular hazard predicted by the tool depends on a number of environmental, optical, and human factors, which can be uncertain.
- The system output calculation is a DNI-based approximation that assumes clear, sunny skies year-round. It should not be used in place of more rigorous modelling methods.
- Hazard zone boundaries shown in the Glare Hazard plot are an approximation and visual aid. Actual ocular impact outcomes encompass a continuous, not discrete, spectrum.
- Glare locations displayed on receptor plots are approximate. Actual glare-spot locations may differ.
- The program does not consider glint (momentary flashes of bright light, often caused by a moving source).

**This copied document to be made available
for the sole purpose of enabling
its consideration and review as
part of a planning process under the
Planning and Environment Act 1987.
The document must not be used for any
purpose which may breach any
copyright**

**ADVERTISED
PLAN**

2. Glare principles

2.1 Angle of incidence and reflection

Solar panels aim to maximise the conversion of sunlight energy to electrical energy by, in parts, minimising energy loss through reflection of sunlight. Some manufacturers of solar panels provide Anti-Reflective Coatings (ARC) to reduce surface reflectivity. ARC is most effective with small angles of incidence (the angle between panel perpendicular and sun) and is not as effective as angle of incidence increases, demonstrated by Yellowhair, 2015, Figure 2. The SGHAT model explains this as the greater surface texturing can increase the size of the subtended source angle (i.e., glare spot) increasing reflection. SGHAT can account for ARC.

Figure 2 also demonstrates that reflected light is fairly insignificant at low angles of incidence, however, increases exponentially as angle of incidence exceeds 60°.

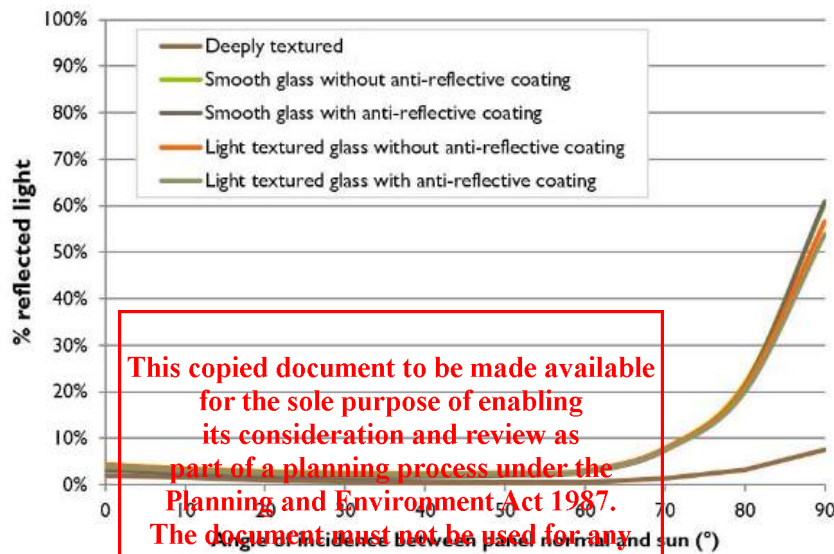

Figure 2 Angle of incidence and panel reflectance (Yellowhair, 2015)

Glare intensity depends on the surface of solar panels. Clean solar panels with smooth glass create specular reflection, whereas solar panels with ARC or dust can result in diffuse reflection as shown in Figure 3, below. Specular reflection has a direction symmetrical to the angle of incidence with reference to the panel's normal direction. This results in more intense reflections.

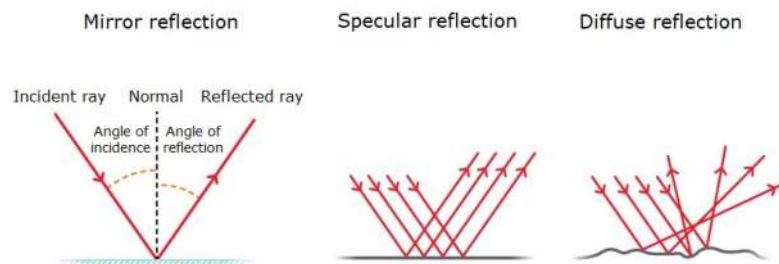

Figure 3 Specular and diffuse reflection

Diffuse reflections result from a beam of light being scattered in multiple angles due to a rough surface. Such reflections may occur on a solar farm due to any slight roughness of the panel surface type, or by dust and contaminants. Diffuse reflection lowers the intensity of the overall specular reflection and therefore it can be considered to lower the likelihood of hazardous glare.

**ADVERTISED
PLAN**

2.2 Direct normal irradiance

Direct normal irradiance (DNI) is the measurement of power that a given surface area may absorb when it is exposed to sunlight, measured in watts per square meter (W/m^2). The maximum irradiance occurs at midday when the sun is directly overhead; however, this irradiance will decrease as the sun angle decreases as the sunlight passes through more of the atmosphere and less energy will reach the solar panel surface. SGHAT accounts for the variation in sunlight intensity by applying a subtractive function depending on the sun angle.

2.3 Glare ocular impact categories

Ocular impact is a measure of the potential for after-image and damage that may occur to the human eye when exposed to glare. Ocular impact is a function of both the magnitude of the reflected sunlight received by the observer “retinal irradiance” (W/cm^2) and the size of the glare source perceived by the observer, measured by the subtended angle of the reflected glare (milliradians). Glare is classified by SGHAT as:

- Low potential for after-image, also referred to as green glare
- Potential for after-image, also referred to as yellow glare
- Potential for permanent eye damage, also referred to as red glare

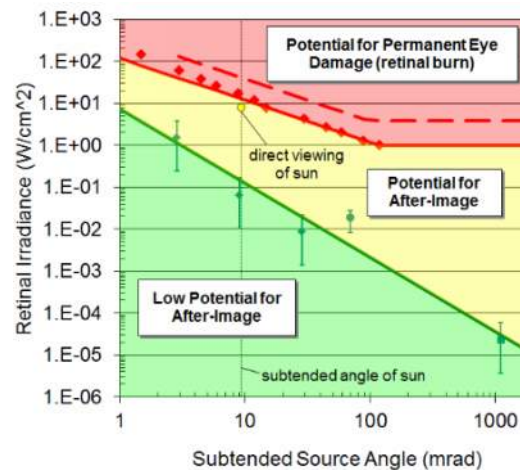

Figure 4 Ocular impact categories (Ho, 2011)

2.4 Scale of glare effects

Glare hazard is the human impact caused by exposure to the reflected light. Factors that contribute to glare hazard for a solar farm include:

- Reflectivity of surfaces
- Angle of incidence
- Strength of the light source
- Receptors
- Distance

Photovoltaic efficiency describes the efficiency or percentage of radiation (sun) energy that can be converted into electrical energy. The more light that can be absorbed by a solar panel, the more efficient the process.

For these reasons, photovoltaic panel surfaces are designed to absorb as much light as possible and limit reflection. However, glare or reflection can still occur at various times throughout the day.

**ADVERTISED
PLAN**

This copied document to be made available for the sole purpose of enabling its consideration and review as part of a planning process under the Planning and Environment Act 1987. The document must not be used for any purpose which may breach any copyright

2.5 Intensity

Glare effect can be described as the presence of light within the human field of vision that will result in visual discomfort or impairment. This can be experienced when looking at a reflection of the sun from a surface such as glass, water, or metal. The assessment of the effect of glare varies depending on the intensity of the incoming light, relative to the field of human vision, duration of exposure, size of the glare and distance of the receiver from the glare source.

Glare is defined as either discomfort, or disability glare. Discomfort glare creates difficulty in seeing the object(s) being focused upon whereas disability glare can impair vision for a short or sustained period. Disability glare is a primary and common cause of concern in relation to traffic safety.

The assessment of glare effects and associated scale of effects are primarily based on the assessment distance to the Project, viewer numbers based on location, and potential for afterimage.

- **Distance:** Refers to the distance of the viewer from the Project. The level of impact decreases as distance increases.
- **Number of viewers:** The level of impact is less likely to occur where there are fewer people able to experience afterimage.

Visibility in terms of line of sight towards the Project also plays a factor in the potential for afterimage effect because if the Project is not visible from a specific location, then there is no chance for afterimage.

ADVERTISED PLAN

**This copied document to be made available
for the sole purpose of enabling
its consideration and review as
part of a planning process under the
Planning and Environment Act 1987.
The document must not be used for any
purpose which may breach any
copyright**

3. Methodology

3.1 Aviation impact assessment

In the event of absence of particular guidelines, GHD has used guidance from the American Federal Aviation Administration (FAA), on solar glare hazard analysis. According to the interim FAA policy, effective October 2013, SGHAT was required to “demonstrate that the proposed solar energy system meets the following standards:

- No potential for glint or glare in the existing or planned Airport Traffic Control Tower (ATCT) cab, and
- No potential for glare or “low potential for after-image” (shown in green in Figure 4) “along the final approach path for any existing landing threshold or future landing thresholds (including any planned interim phases of the landing thresholds) as shown on the current FAA-approved Airport Layout Plan (ALP). The final approach path is defined as two (2) miles from fifty (50) feet above the landing threshold using a standard three (3rd) glidepath.”

This advice has been reduced in the final policy, effective May 2021 that the FAA “will rely on the airport sponsor to include a statement that the proposed solar project will not result in ocular (i.e., glint or glare) impacts to the airport’s ATCT cab”.

3.2 Road users impact assessment

The SGHAT route receptor function can assess glare impact for vehicle operators traveling along continuous paths such as roads or railways. For a standard approach, glare for roads is assessed for a height representing the driver’s position in a light vehicle (LV).

The SGHAT algorithm does not consider obstacles (either man-made or natural) between the observation points and the solar farm that may obstruct observed glare, such as trees, hills, buildings, etc.

3.3 Community users impact assessment

In SGHAT, an Observation Point (OP) receptor allows the simulation of an observer at a single, location, defined by a latitude, longitude, elevation, and a height above ground. OP receptors were used to assess the potential glare for a pedestrian, 1.76 m was used for average viewing height of an adult in Australia.

3.4 Hierarchy of controls

GHD approaches solar glare mitigation with the Hierarchy of Controls, as depicted in Figure 5:

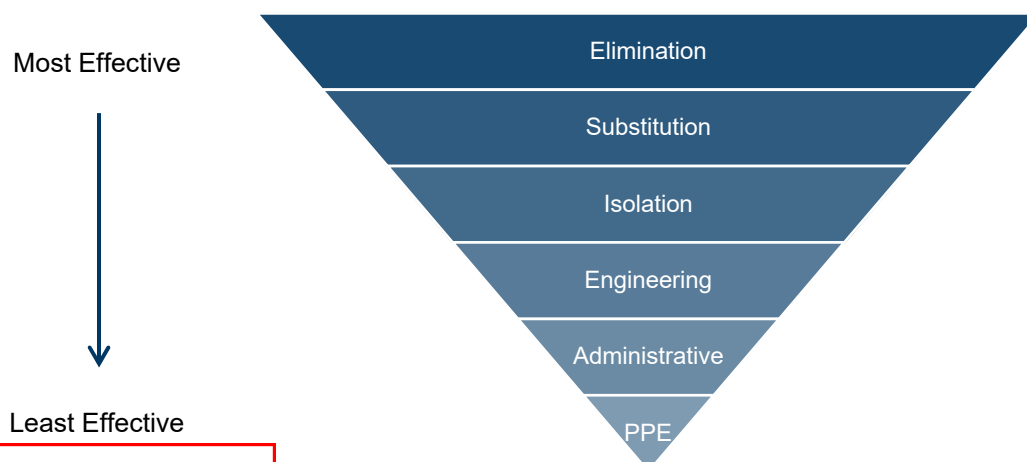

Figure 5 The Hierarchy of Controls

This copied document to be made available for the sole purpose of enabling its consideration and review as part of a planning process under the Planning and Environment Act 1987. The document must not be used for any purpose which may breach any copyright

The highest control in the hierarchy that can possibly be used, should be implemented to minimize risk.

With regard to the impact of glare due to solar arrays, the possible mitigation strategies are:

- **Elimination:** Moving the solar array to a location where it does not have the potential to produce glare that affects sensitive receptors. This involves moving the array to a location that is isolated from any public roads, airports, residences, and culturally significant areas.
- **Substitution:** Altering the orientation and/or tilt angle of the panels. Fixed 35 degrees towards east arrays with a tilt angle of 10° have been considered for the assessment.
- **Isolation:** Obstructing glare with barriers or vegetation. This approach is appropriate for stationary observers and roads; however, it is not practical for obstructing glare in the case of approaching aircraft as barriers would need to be a considerable height.
- **Engineering:** The selection of solar panels with ARC slightly reduces glare intensity and improves energy generation. However, it is not very effective at low sun angles (high angle of incidence). The Trina 600 Wp panels that have proposed feature an ARC. Additionally, proposal of bifacial panel will reduce the glare effect.
- **Administration:** Advising road users and visitors of the glare hazard times.
- **PPE:** Using personal protective equipment such as sunglasses.

ADVERTISED PLAN

This copied document to be made available for the sole purpose of enabling its consideration and review as part of a planning process under the Planning and Environment Act 1987. The document must not be used for any purpose which may breach any copyright

4. Modelling

4.1 Design parameters

The glare study used the assumptions and considerations set out in the feasibility study report. The assessment considered the solar farm layout as shown in Figure 6 below. The concept design proposes PV array covering a total area of approximately 8.4 ha.

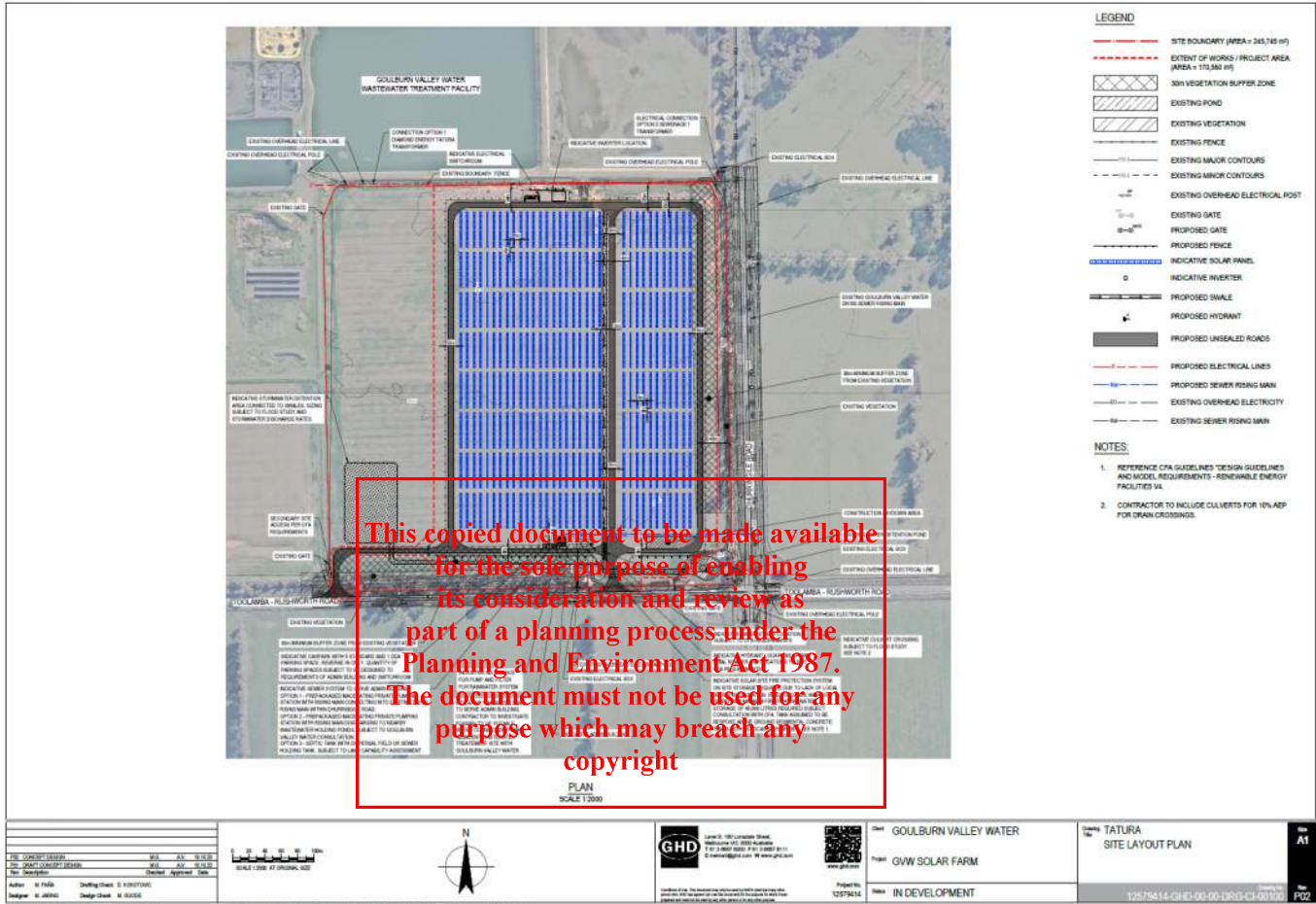

Figure 6 Concept site layout

The parameters considered for this assessment are outlined in Table 1 below.

Table 1 Tatura site solar farm parameters

Parameter/Information	Value/Comments
Solar farm size	5.23 MWp
Maximum tracking angle	60°
Tracking axis orientation	North-south (0°)
Coordinates of solar farm	-36.481729, 145.238646
Module type	Monocrystalline split-cell panel with anti-reflective coating
Layout	Based on concept drawing (12579414-GHD-00-00-DRG-CI-00100)

The proposed panels are single-axis trackers orientated north to south with a maximum tracking angle of 60°, mounted at 1.59 m from the ground, shown in Figure 7.

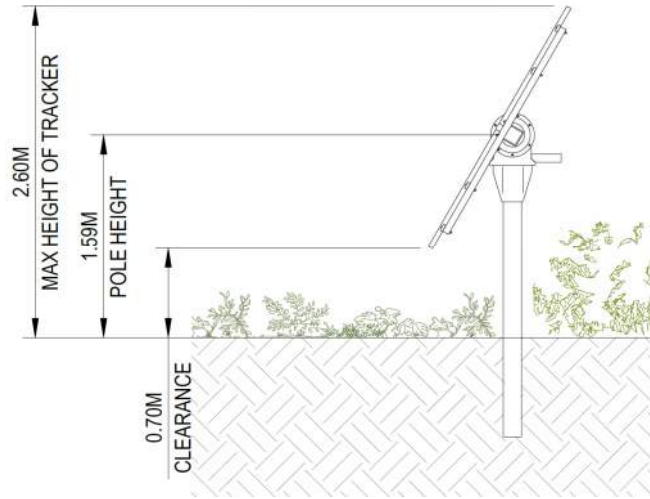

Figure 7 Indicative cross-section of single-axis solar tracker mounting structure

The following polygon vertex parameters were used in the SGHAT simulation to model the area occupied by the panels.

Table 2 Tatura site boundary parameters

	Vertex	Latitude (°)	Longitude (°)	Ground elevation (m)	Height above ground (m)	Total elevation (m)
Array 1	1	-36.479848	145.237066	112.00	1.6	113.60
	2	-36.483644	145.237109	113.32	1.6	114.92
	3	-36.483600	145.240231	116.87	1.6	118.47
	4	-36.479822	145.240177	112.83	1.6	114.43

4.2 Flight path receptors

Shepparton Airport is located approximately 15 kilometres to the north-east of the site, seen in Figure 8. Two 2-mile flight path receptors were modelled to simulate an aircraft's straight-line approach towards Runways 36 and 18 as depicted in Figure 9 and Figure 10. The input parameters are provided in Table 3 and Table 4 below. Shepparton Airport does not have an Airport Traffic Control Tower (ATCT) and therefore no ACTC receptor was modelled.

This copied document to be made available for the sole purpose of enabling its consideration and review as part of a planning process under the Planning and Environment Act 1987. The document must not be used for any purpose which may breach any copyright

**ADVERTISED
PLAN**



Figure 8 Shepparton Airport location



Figure 9 Aerial view of Shepparton Airport

This copied document to be made available for the sole purpose of enabling its consideration and review as part of a planning process under the Planning and Environment Act 1987. The document must not be used for any purpose which may breach any copyright

ADVERTISED PLAN

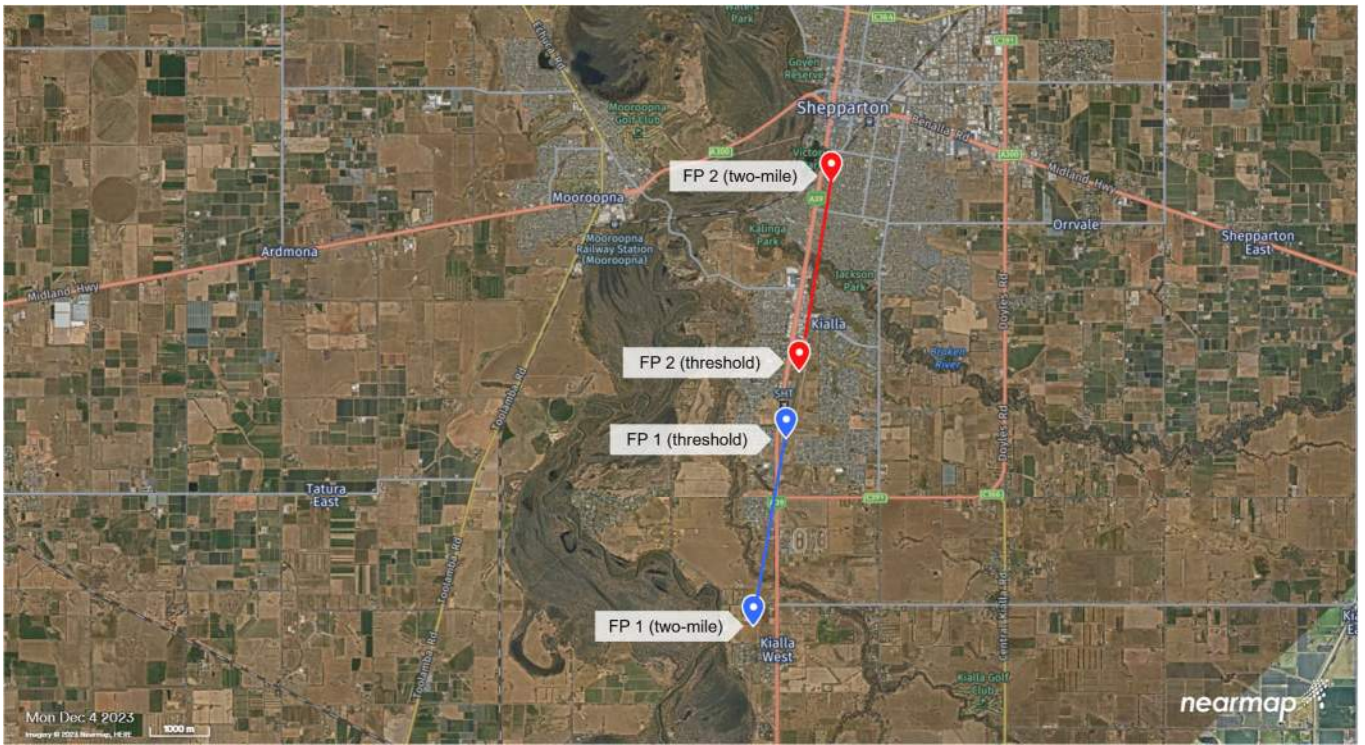

Figure 10 Shepparton Airport two-mile runway and flight path

Table 3 Flight path details

Flight path ID	Flight path name	Direction (bearing)	Glide slope (%)	Threshold crossing height (m)	Azimuthal viewing angle (°)
FP1	Runway 36	10	3	15	50
FP2	Runway 18	190	3	15	50

This copied document to be made available for the sole purpose of enabling its consideration and review as part of a planning process under the Planning and Environment Act 1987. The document must not be used for any purpose which may breach any copyright

Table 4 Flight path receptors parameters

ID	Point type	Latitude (°)	Longitude (°)	Ground elevation (m)	Height above ground (m)	Total elevation (m)
FP 1	Threshold	-36.432291	145.390619	114.00	15.24	129.24
	Two-mile	-36.460764	145.384371	113.62	184.31	297.92
FP2	Threshold	-36.422067	145.392975	113.58	15.24	128.82
	Two-mile	-36.393594	145.399222	113.95	183.55	297.51

4.3 Route receptors

The SGHAT route receptor function can simulate observers traveling along continuous paths such as roads or railways. This function was used to represent both light vehicles (LVs) and heavy vehicles (HVs) travelling along the nearby roads. SGHAT nominates a default observer viewing angle of 50° left and right of the visual center line (total field of view 100°).

The glare impact was assessed on four of the nearest roads bounding the site of the proposed PV plant location. These route receptors, ranging between 2 km to 3 km, are depicted in Figure 11 below. To simulate the impact for day-to-day users of the highway, a receptor height of 2 m was selected for this assessment. The route receptor parameters for the roads are provided in Table 5 below.

ADVERTISED
PLAN



Figure 11 Route receptors and observation points

Table 5 Route receptors parameters

ID	Vertex	Latitude (deg)	Longitude (°)	Ground elevation (m)	Height above ground (m)	Total elevation (m)
Route 1	1	-36.468774	145.241051	115.69	2	117.69
	2	-36.491481	145.241065	116.64	2	118.64
Route 2	1	-36.484178	145.216174	116.86	2	118.86
	2	-36.484264	145.250786	118.76	2	120.76
Route 3	1	-36.468649	145.222612	114.75	2	116.75
	2	-36.491355	145.222698	117.00	2	119.00
Route 4	1	-36.469478	145.221110	114.00	2	116.00
	2	-36.469478	145.242181	114.74	2	116.74

This copied document to be made available for the sole purpose of enabling its consideration and review as part of a planning process under the Planning and Environment Act 1987. The document must not be used for any purpose which may breach any copyright

ADVERTISED PLAN

4.4 Observer points

In ForgeSolar, an Observation Point (OP) receptor enables the simulation of an observer at a specific, defined location, characterized by latitude, longitude, elevation, and height above the ground. OP receptors were employed to evaluate viewpoints (VP) identified as sensitive visual receptors in relation to the solar farm's location. The selection of OPs was guided by satellite imagery, taking into account the presence of dwellings and human activities. The parameters and descriptions for the OPs are provided in Table 6 below, and their locations are depicted in Figure 11 above.

Table 6 Discrete observation point receptors

ID	Latitude (°)	Longitude (°)	Ground Elevation (m)	Height above ground (m)	Total elevation (m)	Comments
OP 1	-36.480271	145.244307	118.13	1.76	119.89	Building located 500 m east of proposed array
OP 2	-36.483644	145.253508	117.42	1.76	119.18	Building located 1.2 km east of south-east corner of proposed array
OP 3	-36.480711	145.254688	116.48	1.76	118.24	Building located 1.2 km east of north-east corner of proposed array
OP 4	-36.476852	145.256694	116.81	1.76	118.57	Building located 1.4 km north-east of north-east corner of proposed array
OP 5	-36.484994	145.248461	118.28	1.76	120.04	Building located 750 m south-east of south-east corner of proposed array
OP 6	-36.489607	145.230892	117.03	1.76	118.07	Building located 770 m south-west of south-west corner of proposed array
OP 7	-36.491806	145.239133	116.61	1.76	118.37	Building located 850 m south of south-east corner of proposed array
OP 8	-36.492195	145.242834	116.24	1.76	118.00	Building located 930 m south-east of south-east corner of proposed array
OP 9	-36.481423	145.225613	117.01	1.76	118.77	Building located 1.2 km west of proposed array
OP 10	-36.487059	145.217942	116.30	1.76	118.06	Building located 1.9 km south-west of proposed array
OP 11	-36.475652	145.219933	116.44	1.76	118.20	Building located 1.8 km north-west of proposed array
OP 12	-36.474414	145.225983	116.47	1.76	118.23	Building located 1.4 km north-west of proposed array

**ADVERTISED
PLAN**

ID	Latitude (°)	Longitude (°)	Ground Elevation (m)	Height above ground (m)	Total elevation (m)	Comments
OP 13	-36.470720	145.217188	116.86	1.76	118.62	Building located 2.2 km north-west of proposed array
OP 14	-36.479978	145.215468	115.89	1.76	117.65	Building located 2.1 km west of proposed array
OP 15	-36.467382	145.224824	116.07	1.76	117.83	Building located 2 km north-west of proposed array
OP 16	-36.465743	145.220597	116.83	1.76	118.59	Building located 2.4 km north-west of proposed array
OP 17	-36.459237	145.230467	115.00	1.76	116.76	Building located 2.6 km north-west of proposed array
OP 18	-36.468959	145.242778	113.90	1.76	115.66	Building located 1.4 km north-east of proposed array
OP 19	-36.466516	145.236207	115.34	1.76	117.10	Building located 1.4 km north of north-west corner of proposed array

ADVERTISED PLAN

This copied document to be made available for the sole purpose of enabling its consideration and review as part of a planning process under the Planning and Environment Act 1987. The document must not be used for any purpose which may breach any copyright

ADVERTISED PLAN

5. Results

5.1 Summary

Glare simulations were completed using ForgeSolar and the results are summarized in Table 7 below. Potential for glare is expressed in total annual hours of either green, yellow, or red glare as specified in section 2.3.

Table 7 Potential total annual glare duration

Observers	Receptor Type	Receptor ID	Total annual glare predicted (hours)		
			Green	Yellow	Red
Airport	Flight Path	FP 1	0	0	0
		FP 2	4.4	0	0
Drivers Commuters Pedestrians	Route Receptor	Route 1	0	0	0
		Route 2	5.5	16.2	0
		Route 3	0	0	0
		Route 4	0	0	0
People	Observation Point	OP 1	5.3	0	0
		OP 2	0	0	0
		OP 3	0	0	0
		OP 4	0	0	0
		OP 5	0	0	0
		OP 6	0	0	0
		OP 7	0	0	0
		OP 8	0	0	0
		OP 9	0	0	0
		OP 10	0	0	0
		OP 11	0	0	0
		OP 12	0	0	0
		OP 13	0	0	0
		OP 14	0	0	0
		OP 15	0	0	0
		OP 16	0	0	0
		OP 17	0	0	0
		OP 18	0	0	0
		OP 19	0	0	0

This copied document to be made available
 for the sole purpose of enabling
 its consideration and review as
 part of a planning process under the
 Planning and Environment Act 1987.
 The document must not be used for any
 purpose which may breach any
 copyright

5.2 Shepparton Airport receptors

Only potential for green glare was forecasted for Flight Path 2 (Runway 18 running north to south) between late-November to mid-January. The glare is predicted to last up to 8 minutes per day, between the evening hours of 7:00 pm to 8:00 pm. It is noted that glare will not cause any problems for the normal operation of the airport. Figure 12 shows the annual predicted glare occurrence and daily duration of glare for Flight Path 2.

A total of 4.4 hours of green glare is expected to occur each year for Flight Path 2.

ADVERTISED PLAN

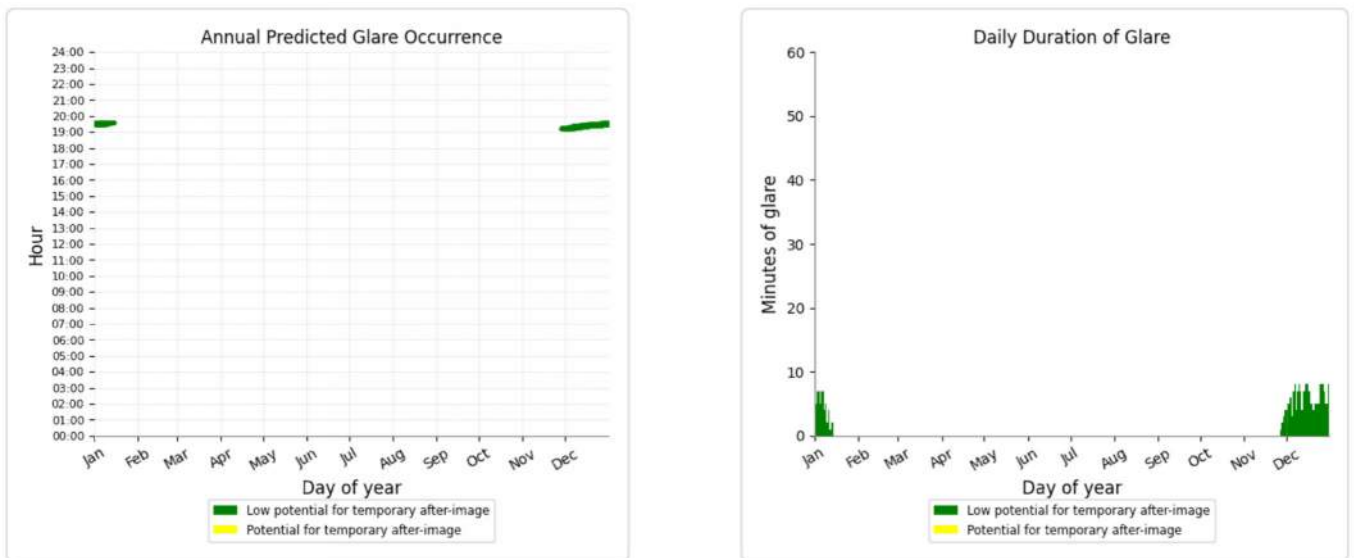

Figure 12 Predicted glare for Flight Path 2 (Runway 18) receptors for Shepparton Airport

5.3 Route receptors

Green and yellow glare have been forecasted for Route 2 receptors along Toolamba-Rushworth Road, the nearest road south of the site. Potential glare is expected through late-March to mid-October each year, with an average of about 10 minutes per day of yellow glare. Both yellow and green glare are predicted during the morning hours between 6:00 am to 8:00 am, and in the evening between 4:45 pm and 6:15 pm. Green glare is expected for less than 1 minute per day from May to early August, and up to 8 minutes per day throughout April and early-August to mid-September. The annual predicted glare occurrence and daily duration of glare are provided below in Figure 13.

Annually it is predicted that 5.5 hours of green glare and 16.2 hours of yellow glare will occur along Toolamba-Rushworth Road.

This copied document to be made available for the sole purpose of enabling its consideration and review as part of a planning process under the Planning and Environment Act 1987. The document must not be used for any purpose which may breach any copyright

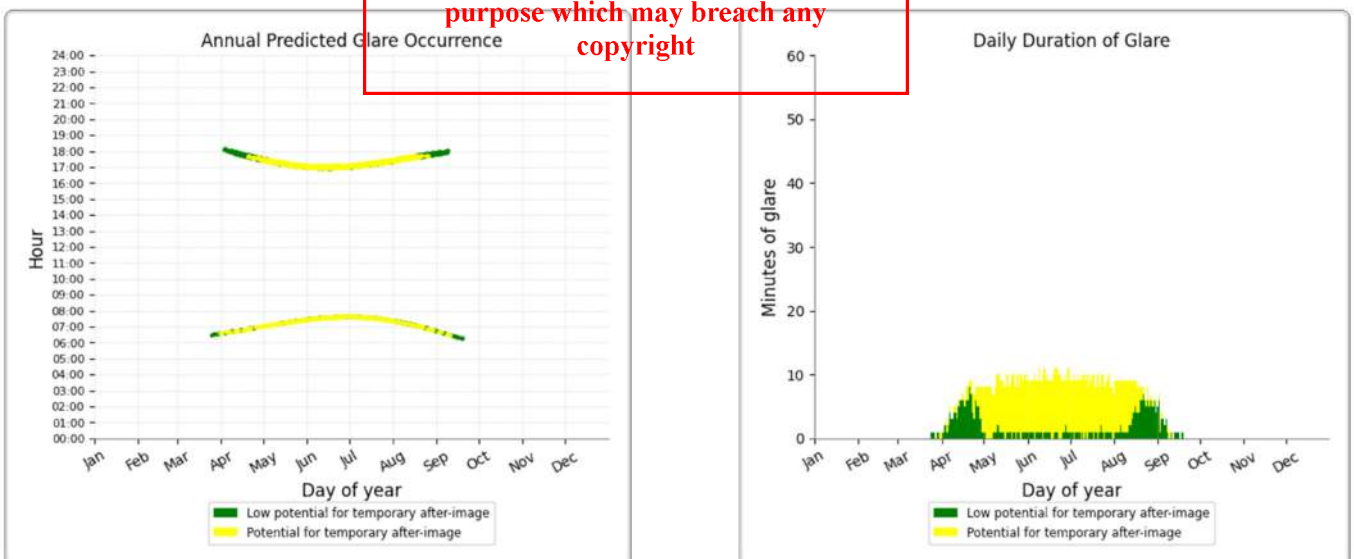

Figure 13 Predicted glare for Route 2 along Toolamba-Rushworth Road

5.4 Observer point receptors

Only OP 1, the nearest observer point to the site, is predicted to experience potential for glare. At OP 1, green glare potential is predicted throughout November and December to early-January between the evening hours of 6:30 pm to 8:00 pm, lasting for up to 7 minutes per day.

Less than 1 minute of green glare potential is also predicted for a single day at the very end of August. No yellow glare is predicted. Figure 14 below depicts annual predicted glare occurrence and daily duration of glare.

Annually it is predicted that 5.3 hours of green glare will occur at observer point 1.

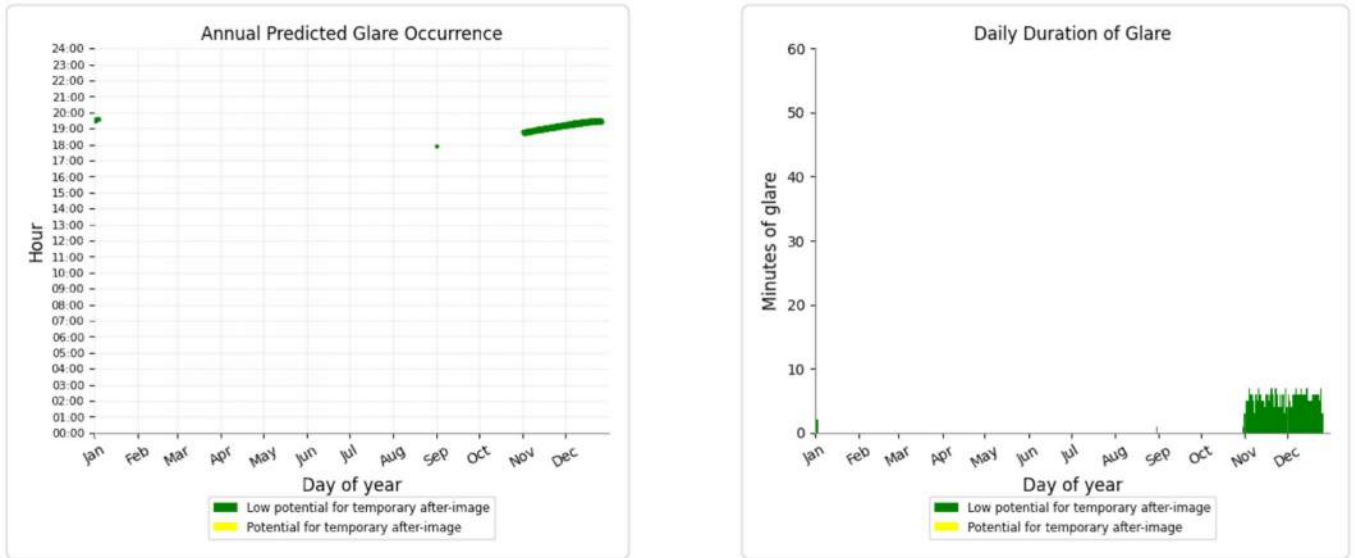

Figure 14 Predicted glare for OP 1 (Observer Point 1)

For details on the hazard plot, predicted PV glare luminance, and for validation, three reports have been exported from the ForgeSolar tool and are attached as Appendices to this report as per Table 8.

Table 8 ForgeSolar Results

Appendix	Description
Appendix A	ForgeSolar Aviation Report (FAA 2021)
Appendix B	ForgeSolar Aviation Report (FAA 2013)
Appendix C	ForgeSolar Complete Analysis Report

This copied document to be made available for the sole purpose of enabling its consideration and review as part of a planning process under the Planning and Environment Act 1987. The document must not be used for any purpose which may breach any copyright

ADVERTISED PLAN

6. Conclusion and recommendations

From the results, it is concluded that during the autumn to spring months, when the sun angle is low in the morning and evening, (predominantly during 6:00 am to 8:00 am and 4:45 pm to 6:15 pm), there is potential glare for route receptors located along the road south of the PV array.

During summer months in the evening between the hours of 6:30 pm to 8 pm, only glare with a low potential to cause an after-image was predicted for nearby point observers to the east of the array, and for flight path receptors north-east of the array.

Table 9 below summarises the number of flight paths, route receptors and observer points out of the data sample which have been predicted to be impacted by green, yellow and red glare.

Table 9 Summary of receptors and observer points impacted by glare

	Green Glare	Yellow Glare	Red Glare
Flight Paths	1	0	0
Route Receptors	1	1	0
Observer Points	1	0	0

A total of 15.2 hours of green glare has been predicted amongst the various flight paths, route receptors and observer points. Green glare has a low potential for after-image and poses little to no threat of damage to the observer during the impacted times.

A total of 16.2 hours of yellow glare has been predicted across the one impacted route receptors. Whilst yellow glare typically has the potential to cause after-image in the observer, where yellow glare has been predicted, the retinal irradiance relative to the subtended source angle is relatively small, and thus is borderline 'green glare' and unlikely to pose any threat or damage to the observer.

No red glare is predicted within the vicinity and surrounds of the proposed PV system, thus at any position relative to the proposed array there is no threat of permanent retinal damage to an observer.

For the route receptors where yellow glare is predicted, the following are recommended as mitigation measures:

- Project owners should consult with the community and ensure that community members, visitors, and airport and aircraft operators are made aware of the potential glare intensity, duration, and occurrence times.
- As a mitigation plan, consider planting vegetation screening or installing glare screening of sufficient height along the route (Toolamba-Rushworth Rd) where the SGHAT model indicates potential yellow glare impact.

This report is intended to be made available for the sole purpose of providing its consideration and review as part of a planning process under the Planning and Environment Act 1987. The document must not be used for any other purpose without the written consent of GHD.

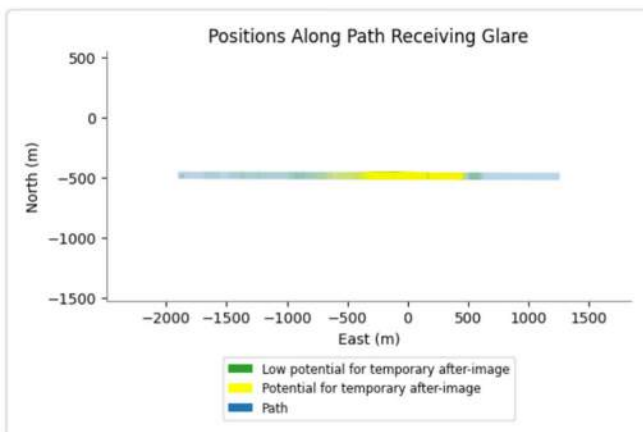

Route 2 – Toolamba-Rushworth Road

Figure 15 Areas impacted by yellow glare

ADVERTISED
PLAN

Appendices

**ADVERTISED
PLAN**

**This copied document to be made available
for the sole purpose of enabling
its consideration and review as
part of a planning process under the
Planning and Environment Act 1987.
The document must not be used for any
purpose which may breach any
copyright**

Appendix A

ForgeSolar Aviation Report (FAA 2021)

This copied document to be made available for the sole purpose of enabling its consideration and review as part of a planning process under the Planning and Environment Act 1987. The document must not be used for any purpose which may breach any copyright

ADVERTISED
PLAN

FORGESOLAR GLARE ANALYSIS

Project: **GVW-Tatura Site**

Proposed 5.23 MWp solar farm with SAT

Site configuration: **SAT system based on concept design-temp-1**

Client: Goulburn Valley Water

Created 13 Dec, 2023

Updated 13 Dec, 2023

Time-step 1 minute

Timezone offset UTC10

Minimum sun altitude 0.0 deg

DNI peaks at 1,000.0 W/m²

Site ID 107786.18693

Ocular transmission coefficient 0.5

Pupil diameter 0.002 m

Eye focal length 0.017 m

Sun subtended angle 9.3 mrad

PV analysis methodology V2



Glare Policy Adherence

The following table estimates the policy adherence of this glare analysis according to the **2021** U.S. Federal Aviation Administration Policy:

Review of Solar Energy System Projects on Federally-Obligated Airports

This policy may require the following criteria be met for solar energy systems on airport property:

- No glare of any kind for Air Traffic Control Tower(s) ("ATCT") at cab height.
- Default analysis and observer characteristics, including 1-minute time step.

ForgeSolar is not affiliated with the U.S. FAA and does not represent or speak officially for the U.S. FAA. ForgeSolar cannot approve or deny projects - results are informational only. Contact the relevant airport and FAA district office for information on policy and requirements.

COMPONENT	STATUS	DESCRIPTION
Analysis parameters	PASS	Analysis time interval and eye characteristics used are acceptable
ATCT(s)	N/A	No ATCT receptors assessed

The referenced policy can be read at <https://www.federalregister.gov/d/2021-09862>

**ADVERTISED
PLAN**

This copied document to be made available for the sole purpose of enabling its consideration and review as part of a planning process under the Planning and Environment Act 1987. The document must not be used for any purpose which may breach any copyright

Component Data

This report includes results for PV arrays and Observation Point ("OP") receptors marked as ATCTs. Components that are not pertinent to the policy, such as routes, flight paths, and vertical surfaces, are excluded.

PV Arrays

Name: PV array 1
Axis tracking: Single-axis rotation
Backtracking: Shade-slope
Tracking axis orientation: 0.0°
Max tracking angle: 60.0°
Resting angle: 0.0°
Ground Coverage Ratio: 0.4
Rated power: 5227.0 kW
Panel material: Smooth glass with AR coating
Reflectivity: Vary with sun
Slope error: correlate with material



Vertex	Latitude (°)	Longitude (°)	Ground elevation (m)	Height above ground (m)	Total elevation (m)
1	-36.479848	145.237066	112.00	1.60	113.60
2	-36.483644	145.237109	113.32	1.60	114.92
3	-36.483600	145.240231	116.87	1.60	118.47
4	-36.479822	145.240177	112.83	1.60	114.43

Observation Point ATCT Receptors

No ATCT receptors were included in the analysis.

**ADVERTISED
PLAN**

This copied document to be made available for the sole purpose of enabling its consideration and review as part of a planning process under the Planning and Environment Act 1987. The document must not be used for any purpose which may breach any copyright

Glare Analysis Results

Summary of Results No glare predicted

PV Array	Tilt	Orient	Annual Green Glare		Annual Yellow Glare		Energy
	°	°	min	hr	min	hr	kWh
PV array 1	SA tracking	SA tracking	0	0.0	0	0.0	14,640,000.0

No ATCT receptors were included in the analysis.

PV: PV array 1

No ATCT receptors assessed.

**ADVERTISED
PLAN**

This copied document to be made available for the sole purpose of enabling its consideration and review as part of a planning process under the Planning and Environment Act 1987. The document must not be used for any purpose which may breach any copyright

Assumptions

"Green" glare is glare with low potential to cause an after-image (flash blindness) when observed prior to a typical blink response time.

"Yellow" glare is glare with potential to cause an after-image (flash blindness) when observed prior to a typical blink response time.

Times associated with glare are denoted in Standard time. For Daylight Savings, add one hour.

The algorithm does not rigorously represent the detailed geometry of a system; detailed features such as gaps between modules, variable height of the PV array, and support structures may impact actual glare results. However, we have validated our models against several systems, including a PV array causing glare to the air-traffic control tower at Manchester-Boston Regional Airport and several sites in Albuquerque, and the tool accurately predicted the occurrence and intensity of glare at different times and days of the year.

Several V1 calculations utilize the PV array centroid, rather than the actual glare spot location, due to algorithm limitations. This may affect results for large PV footprints. Additional analyses of array sub-sections can provide additional information on expected glare. This primarily affects V1 analyses of path receptors.

Random number computations are utilized by various steps of the annual hazard analysis algorithm. Predicted minutes of glare can vary between runs as a result. This limitation primarily affects analyses of Observation Point receptors, including ATCTs. Note that the SGHAT/ ForgeSolar methodology has always relied on an analytical, qualitative approach to accurately determine the overall hazard (i.e. green vs. yellow) of expected glare on an annual basis.

The analysis does not automatically consider obstacles (either man-made or natural) between the observation points and the prescribed solar installation that may obstruct observed glare, such as trees, hills, buildings, etc.

The subtended source angle (glare spot size) is constrained by the PV array footprint size. Partitioning large arrays into smaller sections will reduce the maximum potential subtended angle, potentially impacting results if actual glare spots are larger than the sub-array size. Additional analyses of the combined area of adjacent sub-arrays can provide more information on potential glare hazards. (See previous point on related limitations.)

The variable direct normal irradiance (DNI) feature (if selected) scales the user-prescribed peak DNI using a typical clear-day irradiance profile. This profile has a lower DNI in the mornings and evenings and a maximum at solar noon. The scaling uses a clear-day irradiance profile based on a normalized time relative to sunrise, solar noon, and sunset, which are prescribed by a sun-position algorithm and the latitude and longitude obtained from Google maps. The actual DNI on any given day can be affected by cloud cover, atmospheric attenuation, and other environmental factors.

The ocular hazard predicted by the tool depends on a number of environmental, optical, and human factors, which can be uncertain. We provide input fields and typical ranges of values for these factors so that the user can vary these parameters to see if they have an impact on the results. The speed of SGHAT allows expedited sensitivity and parametric analyses.

The system output calculation is a DNI-based approximation that assumes clear, sunny skies year-round. It should not be used in place of more rigorous modeling methods.

Hazard zone boundaries shown in the Glare Hazard plot are an approximation and visual aid based on aggregated research data. Actual ocular impact outcomes encompass a continuous, not discrete, spectrum.

Glare locations displayed on receptor plots are approximate. Actual glare-spot locations may differ.

Refer to the Help page at www.forgesolar.com/help/ for assumptions and limitations not listed here.

Default glare analysis parameters and observer eye characteristics (for reference only):

- Analysis time interval: 1 minute
- Ocular transmission coefficient: 0.5
- Pupil diameter: 0.002 meters
- Eye focal length: 0.017 meters
- Sun subtended angle: 9.3 milliradians

This copied document to be made available for the sole purpose of enabling its consideration and review as part of a planning process under the Planning and Environment Act 1987. The document must not be used for any purpose which may breach any copyright

2016 © Sims Industries d/b/a ForgeSolar, All Rights Reserved.

**ADVERTISED
PLAN**

Appendix B

ForgeSolar Aviation Report (FAA 2013)

This copied document to be made available
for the sole purpose of enabling
its consideration and review as
part of a planning process under the
Planning and Environment Act 1987.
The document must not be used for any
purpose which may breach any
copyright

ADVERTISED
PLAN

FORGESOLAR GLARE ANALYSIS

Project: **GVW-Tatura Site**

Proposed 5.23 MWp solar farm with SAT

Site configuration: **SAT system based on concept design-temp-1**

Analysis conducted by Anto Jose (anto.jose@ghd.com) at 03:28 on 13 Dec, 2023.

U.S. FAA 2013 Policy Adherence

The following table summarizes the policy adherence of the glare analysis based on the 2013 U.S. Federal Aviation Administration Interim Policy 78 FR 63276. This policy requires the following criteria be met for solar energy systems on airport property:

- No "yellow" glare (potential for after-image) for any flight path from threshold to 2 miles
- No glare of any kind for Air Traffic Control Tower(s) ("ATCT") at cab height.
- Default analysis and observer characteristics (see list below)

ForgeSolar does not represent or speak officially for the FAA and cannot approve or deny projects. Results are informational only.

COMPONENT	STATUS	DESCRIPTION
Analysis parameters	PASS	Analysis time interval and eye characteristics used are acceptable
2-mile flight path(s)	PASS	Flight path receptor(s) do not receive yellow glare
ATCT(s)	N/A	No ATCT receptors designated

Default glare analysis parameters and observer eye characteristics (for reference only):

- Analysis time interval: 1 minute
- Ocular transmission coefficient: 0.5
- Pupil diameter: 0.002 meters
- Eye focal length: 0.017 meters
- Sun subtended angle: 9.3 milliradians

FAA Policy 78 FR 63276 can be read at <https://www.federalregister.gov/d/2013-24729>

This copied document to be made available for the sole purpose of enabling its consideration and review as part of a planning process under the Planning and Environment Act 1987. The document must not be used for any purpose which may breach any copyright

**ADVERTISED
PLAN**

SITE CONFIGURATION

Analysis Parameters

DNI: peaks at 1,000.0 W/m²
 Time interval: 1 min
 Ocular transmission coefficient: 0.5
 Pupil diameter: 0.002 m
 Eye focal length: 0.017 m
 Sun subtended angle: 9.3 mrad
 Site Config ID: 107786.18693
 Methodology: V2

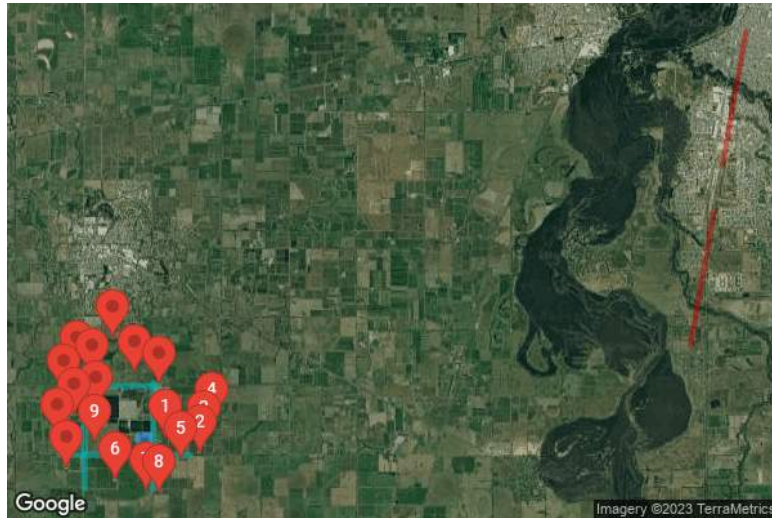

PV Array(s)

Name: PV array 1
Axis tracking: Single-axis rotation
Backtracking: Shade-slope
Tracking axis orientation: 0.0°
Max tracking angle: 60.0°
Resting angle: 0.0°
Ground Coverage Ratio: 0.4
Rated power: 5227.0 kW
Panel material: Smooth glass with AR coating
Reflectivity: Vary with sun
Slope error: correlate with material



Vertex	Latitude (°)	Longitude (°)	Ground elevation (m)	Height above ground (m)	Total elevation (m)
1	-36.479848	145.237066	112.00	1.60	113.60
2	-36.483644	145.237109	113.32	1.60	114.92
3	-36.483600	145.240231	116.87	1.60	118.47
4	-36.479822	145.240177	112.83	1.60	114.43

ADVERTISED PLAN

This copied document to be made available for the sole purpose of enabling its consideration and review as part of a planning process under the Planning and Environment Act 1987. The document must not be used for any purpose which may breach any copyright

Flight Path Receptor(s)

Name: FP 1

Description:

Threshold height: 15 m

Direction: 10.0°

Glide slope: 3.0°

Pilot view restricted? Yes

Vertical view: 30.0°

Azimuthal view: 50.0°



Point	Latitude (°)	Longitude (°)	Ground elevation (m)	Height above ground (m)	Total elevation (m)
Threshold	-36.432291	145.390619	114.00	15.24	129.24
Two-mile	-36.460764	145.384371	113.62	184.31	297.92

Name: FP 2

Description:

Threshold height: 15 m

Direction: 190.0°

Glide slope: 3.0°

Pilot view restricted? Yes

Vertical view: 30.0°

Azimuthal view: 50.0°



Point	Latitude (°)	Longitude (°)	Ground elevation (m)	Height above ground (m)	Total elevation (m)
Threshold	-36.422067	145.392975	113.58	15.24	128.82
Two-mile	-36.393594	145.399222	113.95	183.55	297.51

**ADVERTISED
PLAN**

This copied document to be made available for the sole purpose of enabling its consideration and review as part of a planning process under the Planning and Environment Act 1987. The document must not be used for any purpose which may breach any copyright

Discrete Observation Receptors

Name	ID	Latitude (°)	Longitude (°)	Elevation (m)	Height (m)
OP 1	1	-36.480271	145.244307	118.13	1.76
OP 2	2	-36.483644	145.253508	117.42	1.76
OP 3	3	-36.480711	145.254688	116.48	1.76
OP 4	4	-36.476852	145.256694	116.81	1.76
OP 5	5	-36.484994	145.248461	118.28	1.76
OP 6	6	-36.489607	145.230892	116.31	1.76
OP 7	7	-36.491806	145.239133	116.61	1.76
OP 8	8	-36.492195	145.242834	116.24	1.76
OP 9	9	-36.481423	145.225613	117.01	1.76
OP 10	10	-36.487059	145.217942	116.30	1.76
OP 11	11	-36.475652	145.219933	116.44	1.76
OP 12	12	-36.474414	145.225983	116.47	1.76
OP 13	13	-36.470720	145.217188	116.86	1.76
OP 14	14	-36.479978	145.215468	115.89	1.76
OP 15	15	-36.467382	145.224824	116.07	1.76
OP 16	16	-36.465743	145.220597	116.83	1.76
OP 17	17	-36.459237	145.230467	115.00	1.76
OP 18	18	-36.468959	145.242778	113.90	1.76
OP 19	19	-36.466516	145.236207	115.34	1.76

Route Receptor(s)

Name: Route 1
Path type: Two-way
Observer view angle: 50.0°

Note: Route receptors are excluded from this FAA policy review. Use the 2-mile flight path receptor to simulate flight paths according to FAA guidelines.



Vertex	Latitude (°)	Longitude (°)	Ground elevation (m)	Height above ground (m)	Total elevation (m)
1	-36.468774	145.241051	115.69	2.00	117.69
2	-36.491481	145.241065	116.64	2.00	118.64

**ADVERTISED
PLAN**

This copied document to be made available for the sole purpose of enabling its consideration and review as part of a planning process under the Planning and Environment Act 1987. The document must not be used for any purpose which may breach any copyright

Name: Route 2
Path type: Two-way
Observer view angle: 50.0°

Note: Route receptors are excluded from this FAA policy review. Use the 2-mile flight path receptor to simulate flight paths according to FAA guidelines.



Vertex	Latitude (°)	Longitude (°)	Ground elevation (m)	Height above ground (m)	Total elevation (m)
1	-36.484178	145.216174	116.86	2.00	118.86
2	-36.484264	145.250786	118.76	2.00	120.76

Name: Route 3
Path type: Two-way
Observer view angle: 50.0°

Note: Route receptors are excluded from this FAA policy review. Use the 2-mile flight path receptor to simulate flight paths according to FAA guidelines.



Vertex	Latitude (°)	Longitude (°)	Ground elevation (m)	Height above ground (m)	Total elevation (m)
1	-36.468649	145.222612	114.75	2.00	116.75
2	-36.491355	145.222698	117.00	2.00	119.00

This copied document to be made available for the sole purpose of enabling its consideration and review as part of a planning process under the Planning and Environment Act 1987. The document must not be used for any purpose which may breach any copyright

Name: Route 4
Path type: Two-way
Observer view angle: 50.0°

Note: Route receptors are excluded from this FAA policy review. Use the 2-mile flight path receptor to simulate flight paths according to FAA guidelines.



Vertex	Latitude (°)	Longitude (°)	Ground elevation (m)	Height above ground (m)	Total elevation (m)
1	-36.469478	145.221110	114.00	2.00	116.00
2	-36.469478	145.242181	114.74	2.00	116.74

ADVERTISED PLAN

GLARE ANALYSIS RESULTS

Summary of Glare

PV Array Name	Tilt (°)	Orient (°)	"Green" Glare min	"Yellow" Glare min	Energy kWh
PV array 1	SA tracking	SA tracking	913	975	14,640,000.0

Total annual glare received by each receptor

Receptor	Annual Green Glare (min)	Annual Yellow Glare (min)
FP 1	0	0
FP 2	263	0
OP 1	318	0
OP 2	0	0
OP 3	0	0
OP 4	0	0
OP 5	0	0
OP 6	0	0
OP 7	0	0
OP 8	0	0
OP 9	0	0
OP 10	0	0
OP 11	0	0
OP 12	0	0
OP 13	0	0
OP 14	0	0
OP 15	0	0
OP 16	0	0
OP 17	0	0
OP 18	0	0
OP 19	0	0
Route 1	0	0
Route 2	332	975
Route 3	0	0
Route 4	0	0

This copied document to be made available
 for the sole purpose of enabling
 its consideration and review as
 part of a planning process under the
 Planning and Environment Act 1987.
 The document must not be used for any
 purpose which may breach any
 copyright

ADVERTISED
 PLAN

Results for: PV array 1

Receptor	Green Glare (min)	Yellow Glare (min)
FP 1	0	0
FP 2	263	0
OP 1	318	0
OP 2	0	0
OP 3	0	0
OP 4	0	0
OP 5	0	0
OP 6	0	0
OP 7	0	0
OP 8	0	0
OP 9	0	0
OP 10	0	0
OP 11	0	0
OP 12	0	0
OP 13	0	0
OP 14	0	0
OP 15	0	0
OP 16	0	0
OP 17	0	0
OP 18	0	0
OP 19	0	0
Route 1	0	0
Route 2	332	975
Route 3	0	0
Route 4	0	0

Flight Path: FP 1

0 minutes of yellow glare

0 minutes of green glare

**ADVERTISED
PLAN**

This copied document to be made available for the sole purpose of enabling its consideration and review as part of a planning process under the Planning and Environment Act 1987. The document must not be used for any purpose which may breach any copyright

Flight Path: FP 2

0 minutes of yellow glare

263 minutes of green glare

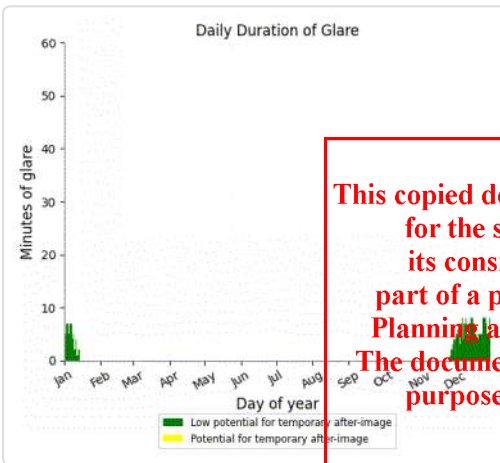
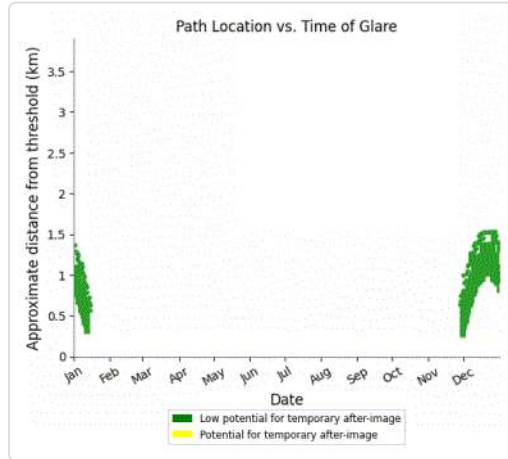
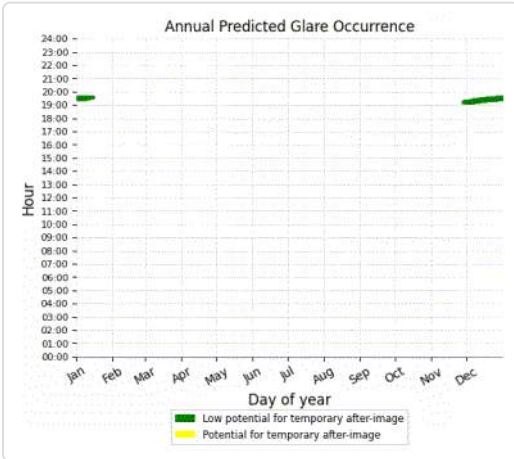

This copied document to be made available for the sole purpose of enabling its consideration and review as part of a planning process under the Planning and Environment Act 1987. The document must not be used for any purpose which may breach any copyright

ADVERTISED PLAN

Point Receptor: OP 1

0 minutes of yellow glare

318 minutes of green glare

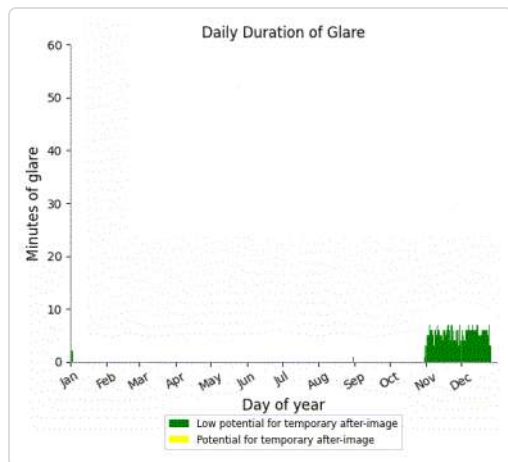
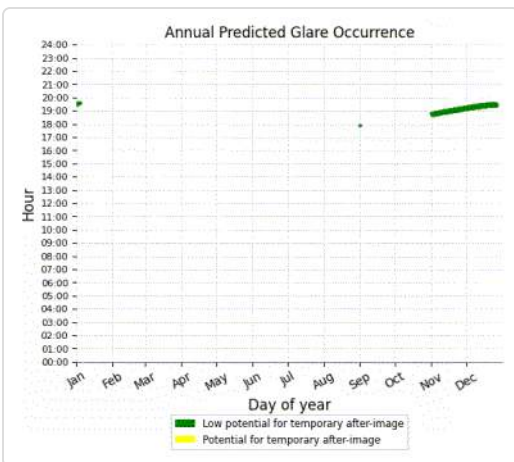

Point Receptor: OP 2

0 minutes of yellow glare
0 minutes of green glare

Point Receptor: OP 3

0 minutes of yellow glare
0 minutes of green glare

Point Receptor: OP 4

0 minutes of yellow glare
0 minutes of green glare

Point Receptor: OP 5

0 minutes of yellow glare
0 minutes of green glare

Point Receptor: OP 6

0 minutes of yellow glare
0 minutes of green glare

Point Receptor: OP 7

0 minutes of yellow glare
0 minutes of green glare

Point Receptor: OP 8

0 minutes of yellow glare
0 minutes of green glare

Point Receptor: OP 9

0 minutes of yellow glare
0 minutes of green glare

Point Receptor: OP 10

0 minutes of yellow glare
0 minutes of green glare

Point Receptor: OP 11

0 minutes of yellow glare
0 minutes of green glare

**ADVERTISED
PLAN**

This copied document to be made available for the sole purpose of enabling its consideration and review as part of a planning process under the Planning and Environment Act 1987. The document must not be used for any purpose which may breach any copyright

Point Receptor: OP 12

0 minutes of yellow glare
0 minutes of green glare

Point Receptor: OP 13

0 minutes of yellow glare
0 minutes of green glare

Point Receptor: OP 14

0 minutes of yellow glare
0 minutes of green glare

Point Receptor: OP 15

0 minutes of yellow glare
0 minutes of green glare

Point Receptor: OP 16

0 minutes of yellow glare
0 minutes of green glare

Point Receptor: OP 17

0 minutes of yellow glare
0 minutes of green glare

Point Receptor: OP 18

0 minutes of yellow glare
0 minutes of green glare

Point Receptor: OP 19

0 minutes of yellow glare
0 minutes of green glare

Route: Route 1

0 minutes of yellow glare
0 minutes of green glare

This copied document to be made available for the sole purpose of enabling its consideration and review as part of a planning process under the Planning and Environment Act 1987. The document must not be used for any purpose which may breach any copyright

**ADVERTISED
PLAN**

Route: Route 2

975 minutes of yellow glare

332 minutes of green glare

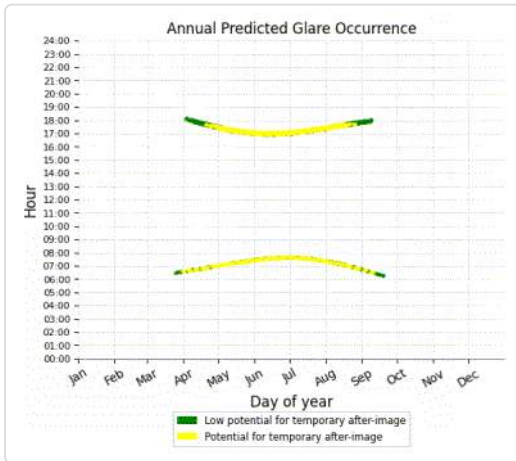

This copied document to be made available for the sole purpose of enabling its consideration and review as part of a planning process under the Planning and Environment Act 1987. The document must not be used for any purpose which may breach any copyright

Route: Route 3

0 minutes of yellow glare

0 minutes of green glare

Route: Route 4

0 minutes of yellow glare

0 minutes of green glare

**ADVERTISED
PLAN**

Assumptions

"Green" glare is glare with low potential to cause an after-image (flash blindness) when observed prior to a typical blink response time.

"Yellow" glare is glare with potential to cause an after-image (flash blindness) when observed prior to a typical blink response time.

Times associated with glare are denoted in Standard time. For Daylight Savings, add one hour.

Glare analyses do not account for physical obstructions between reflectors and receptors. This includes buildings, tree cover and geographic obstructions.

Several calculations utilize the PV array centroid, rather than the actual glare spot location, due to V1 algorithm limitations. This may affect results for large PV footprints. Additional analyses of array sub-sections can provide additional information on expected glare.

The subtended source angle (glare spot size) is constrained by the PV array footprint size. Partitioning large arrays into smaller sections will reduce the maximum potential subtended angle, potentially impacting results if actual glare spots are larger than the sub-array size. Additional analyses of the combined area of adjacent sub-arrays can provide more information on potential glare hazards. (See previous point on related limitations.)

Glare locations displayed on receptor plots are approximate. Actual glare-spot locations may differ.

Glare vector plots are simplified representations of analysis data. Actual glare emanations and results may differ.

The glare hazard determination relies on several approximations including observer eye characteristics, angle of view, and typical blink response time. Actual results and glare occurrence may differ.

Hazard zone boundaries shown in the Glare Hazard plot are an approximation and visual aid based on aggregated research data. Actual ocular impact outcomes encompass a continuous, not discrete, spectrum.

Refer to the Help page at www.forgesolar.com/help/ for assumptions and limitations not listed here.

Appendix C

ForgeSolar Complete Analysis Report

This copied document to be made available for the sole purpose of enabling its consideration and review as part of a planning process under the Planning and Environment Act 1987. The document must not be used for any purpose which may breach any copyright

ADVERTISED
PLAN

ADVERTISED PLAN

FORGESOLAR GLARE ANALYSIS

Project: **GVW-Tatura Site**

Proposed 5.23 MWp solar farm with SAT

Site configuration: **SAT system based on concept design-temp-1**

Client: Goulburn Valley Water

Created 13 Dec, 2023

Updated 13 Dec, 2023

Time-step 1 minute

Timezone offset UTC10

Minimum sun altitude 0.0 deg

DNI peaks at 1,000.0 W/m²

Category 5 MW to 10 MW

Site ID 107786.18693

Ocular transmission coefficient 0.5

Pupil diameter 0.002 m

Eye focal length 0.017 m

Sun subtended angle 9.3 mrad

PV analysis methodology V2

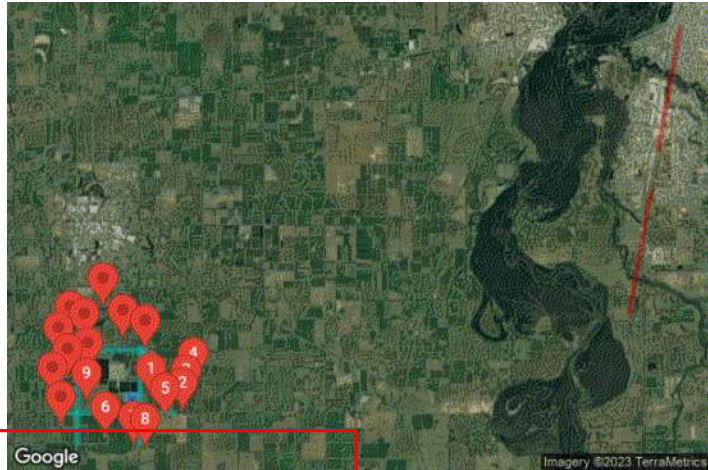

This copied document to be made available for the sole purpose of enabling it to be considered and reviewed as part of a planning process under the Planning and Environment Act 1987. The document must not be used for any purpose which may breach any copyright.

Summary of Results

Glare with potential for temporary after image predicted

PV Array	Tilt °	Annual Green Glare			Annual Yellow Glare	Energy	
		min	hr	min	hr	kWh	
PV array 1	SAT tracking	SA tracking	913	15.2	975	16.2	14,640,000.0

Total glare received by each receptor; may include duplicate times of glare from multiple reflective surfaces.

Receptor	Annual Green Glare		Annual Yellow Glare	
	min	hr	min	hr
Route 1	0	0.0	0	0.0
Route 2	332	5.5	975	16.2
Route 3	0	0.0	0	0.0
Route 4	0	0.0	0	0.0
FP 1	0	0.0	0	0.0
FP 2	263	4.4	0	0.0
OP 1	318	5.3	0	0.0
OP 2	0	0.0	0	0.0
OP 3	0	0.0	0	0.0
OP 4	0	0.0	0	0.0
OP 5	0	0.0	0	0.0
OP 6	0	0.0	0	0.0
OP 7	0	0.0	0	0.0

Receptor	Annual Green Glare		Annual Yellow Glare	
	min	hr	min	hr
OP 8	0	0.0	0	0.0
OP 9	0	0.0	0	0.0
OP 10	0	0.0	0	0.0
OP 11	0	0.0	0	0.0
OP 12	0	0.0	0	0.0
OP 13	0	0.0	0	0.0
OP 14	0	0.0	0	0.0
OP 15	0	0.0	0	0.0
OP 16	0	0.0	0	0.0
OP 17	0	0.0	0	0.0
OP 18	0	0.0	0	0.0
OP 19	0	0.0	0	0.0

ADVERTISED PLAN

This copied document to be made available for the sole purpose of enabling its consideration and review as part of a planning process under the Planning and Environment Act 1987. The document must not be used for any purpose which may breach any copyright

Component Data

PV Arrays

Name: PV array 1
Axis tracking: Single-axis rotation
Backtracking: Shade-slope
Tracking axis orientation: 0.0°
Max tracking angle: 60.0°
Resting angle: 0.0°
Ground Coverage Ratio: 0.4
Rated power: 5227.0 kW
Panel material: Smooth glass with AR coating
Reflectivity: Vary with sun
Slope error: correlate with material



Vertex	Latitude (°)	Longitude (°)	Ground elevation (m)	Height above ground (m)	Total elevation (m)
1	-36.479848	145.237066	112.00	1.60	113.60
2	-36.483644	145.237109	113.32	1.60	114.92
3	-36.483600	145.240231	116.87	1.60	118.47
4	-36.479822	145.240177	112.83	1.60	114.43

Route Receptors

Name: Route 1
Path type: Two-way
Observer view angle: 50.0°



Vertex	Latitude (°)	Longitude (°)	Ground elevation (m)	Height above ground (m)	Total elevation (m)
1	-36.468774	145.241051	115.69	2.00	117.69
2	-36.491481	145.241065	116.64	2.00	118.64

ADVERTISED
 PLAN

This copied document to be made available for the sole purpose of enabling its consideration and review as part of a planning process under the Planning and Environment Act 1987. The document must not be used for any purpose which may breach any copyright

Name: Route 2
Path type: Two-way
Observer view angle: 50.0°



Vertex	Latitude (°)	Longitude (°)	Ground elevation (m)	Height above ground (m)	Total elevation (m)
1	-36.484178	145.216174	116.86	2.00	118.86
2	-36.484264	145.250786	118.76	2.00	120.76

Name: Route 3
Path type: Two-way
Observer view angle: 50.0°



This copied document to be made available
for the sole purpose of enabling
its consideration and review as
part of a planning process under the
Planning and Environment Act 1987.
The document must not be used for any
purpose which may breach any
copyright

Vertex	Latitude (°)	Longitude (°)	Ground elevation (m)	Height above ground (m)	Total elevation (m)
1	-36.468649	145.222612	114.75	2.00	116.75
2	-36.491355	145.222698	117.00	2.00	119.00

Name: Route 4
Path type: Two-way
Observer view angle: 50.0°

**ADVERTISED
PLAN**



Vertex	Latitude (°)	Longitude (°)	Ground elevation (m)	Height above ground (m)	Total elevation (m)
1	-36.469478	145.221110	114.00	2.00	116.00
2	-36.469478	145.242181	114.74	2.00	116.74

Flight Path Receptors

Name: FP 1
Description:
Threshold height: 15 m
Direction: 10.0°
Glide slope: 3.0°
Pilot view restricted? Yes
Vertical view: 30.0°
Azimuthal view: 50.0°



Point	Latitude (°)	Longitude (°)	Ground elevation (m)	Height above ground (m)	Total elevation (m)
Threshold	-36.432291	145.390619	114.00	15.24	129.24
Two-mile	-36.460764	145.384371	113.62	184.31	297.92

Name: FP 2
Description:
Threshold height: 15 m
Direction: 190.0°
Glide slope: 3.0°
Pilot view restricted? Yes
Vertical view: 30.0°
Azimuthal view: 50.0°

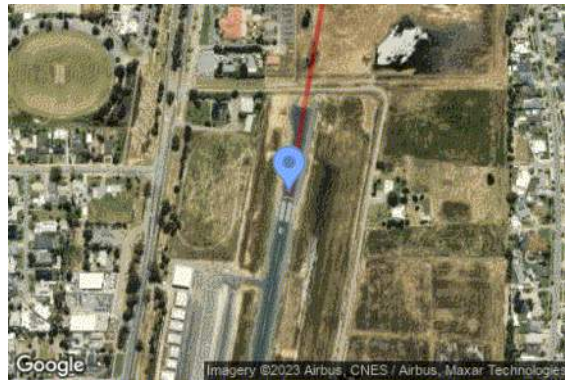

Point	Latitude (°)	Longitude (°)	Ground elevation (m)	Height above ground (m)	Total elevation (m)
Threshold	-36.422067	145.392975	113.58	15.24	128.82
Two-mile	-36.393594	145.399222	113.95	183.55	297.51

**ADVERTISED
PLAN**

This copied document to be made available for the sole purpose of enabling its consideration and review as part of a planning process under the Planning and Environment Act 1987. The document must not be used for any purpose which may breach any copyright

Discrete Observation Point Receptors

Name	ID	Latitude (°)	Longitude (°)	Elevation (m)	Height (m)
OP 1	1	-36.480271	145.244307	118.13	1.76
OP 2	2	-36.483644	145.253508	117.42	1.76
OP 3	3	-36.480711	145.254688	116.48	1.76
OP 4	4	-36.476852	145.256694	116.81	1.76
OP 5	5	-36.484994	145.248461	118.28	1.76
OP 6	6	-36.489607	145.230892	116.31	1.76
OP 7	7	-36.491806	145.239133	116.61	1.76
OP 8	8	-36.492195	145.242834	116.24	1.76
OP 9	9	-36.481423	145.225613	117.01	1.76
OP 10	10	-36.487059	145.217942	116.30	1.76
OP 11	11	-36.475652	145.219933	116.44	1.76
OP 12	12	-36.474414	145.225983	116.47	1.76
OP 13	13	-36.470720	145.217188	116.86	1.76
OP 14	14	-36.479978	145.215468	115.89	1.76
OP 15	15	-36.467382	145.224824	116.07	1.76
OP 16	16	-36.465743	145.220597	116.83	1.76
OP 17	17	-36.459237	145.230467	115.00	1.76
OP 18	18	-36.468959	145.242778	113.90	1.76
OP 19	19	-36.466516	145.236207	115.34	1.76

ADVERTISED PLAN

This copied document to be made available for the sole purpose of enabling its consideration and review as part of a planning process under the Planning and Environment Act 1987. The document must not be used for any purpose which may breach any copyright

Glare Analysis Results

Summary of Results Glare with potential for temporary after-image predicted

PV Array	Tilt °	Orient °	Annual Green Glare		Annual Yellow Glare		Energy kWh
			min	hr	min	hr	
PV array 1	SA tracking	SA tracking	913	15.2	975	16.2	14,640,000.0

Total glare received by each receptor; may include duplicate times of glare from multiple reflective surfaces.

Receptor	Annual Green Glare		Annual Yellow Glare	
	min	hr	min	hr
Route 1	0	0.0	0	0.0
Route 2	332	5.5	975	16.2
Route 3	0	0.0	0	0.0
Route 4	0	0.0	0	0.0
FP 1	0	0.0	0	0.0
FP 2	269	4.4	0	0.0
OP 1	318	5.3	0	0.0
OP 2	0	0.0	0	0.0
OP 3	0	0.0	0	0.0
OP 4	0	0.0	0	0.0
OP 5	0	0.0	0	0.0
OP 6	0	0.0	0	0.0
OP 7	0	0.0	0	0.0
OP 8	0	0.0	0	0.0
OP 9	0	0.0	0	0.0
OP 10	0	0.0	0	0.0
OP 11	0	0.0	0	0.0
OP 12	0	0.0	0	0.0
OP 13	0	0.0	0	0.0
OP 14	0	0.0	0	0.0
OP 15	0	0.0	0	0.0
OP 16	0	0.0	0	0.0
OP 17	0	0.0	0	0.0
OP 18	0	0.0	0	0.0
OP 19	0	0.0	0	0.0

This copied document to be made available for the sole purpose of enabling its consideration and review as part of a planning process under the Planning and Environment Act 1987. The document must not be used for any purpose which may breach any copyright

**ADVERTISED
PLAN**

PV: PV array 1 potential temporary after-image

Receptor results ordered by category of glare

Receptor	Annual Green Glare		Annual Yellow Glare	
	min	hr	min	hr
Route 2	332	5.5	975	16.2
Route 1	0	0.0	0	0.0
Route 3	0	0.0	0	0.0
Route 4	0	0.0	0	0.0
FP 2	263	4.4	0	0.0
FP 1	0	0.0	0	0.0
OP 1	318	5.3	0	0.0
OP 2	0	0.0	0	0.0
OP 3	0	0.0	0	0.0
OP 4	0	0.0	0	0.0
OP 5	0	0.0	0	0.0
OP 6	0	0.0	0	0.0
OP 7	0	0.0	0	0.0
OP 8	0	0.0	0	0.0
OP 9	0	0.0	0	0.0
OP 10	0	0.0	0	0.0
OP 11	0	0.0	0	0.0
OP 12	0	0.0	0	0.0
OP 13	0	0.0	0	0.0
OP 14	0	0.0	0	0.0
OP 15	0	0.0	0	0.0
OP 16	0	0.0	0	0.0
OP 17	0	0.0	0	0.0
OP 18	0	0.0	0	0.0
OP 19	0	0.0	0	0.0

**ADVERTISED
PLAN**

This copied document to be made available for the sole purpose of enabling its consideration and review as part of a planning process under the Planning and Environment Act 1987. The document must not be used for any purpose which may breach any copyright

PV array 1 and Route: Route 2

Yellow glare: 975 min.

Green glare: 332 min.

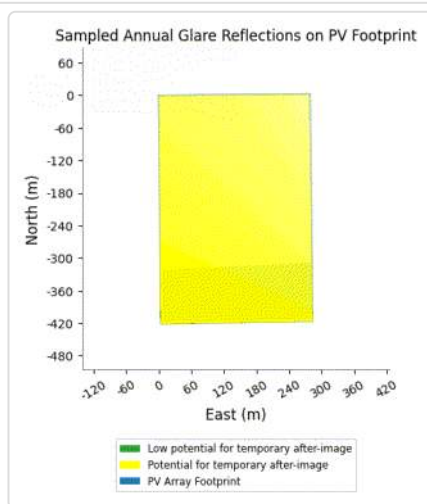
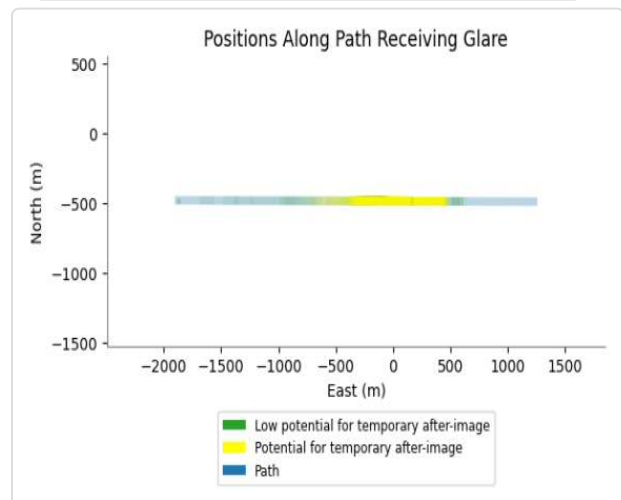
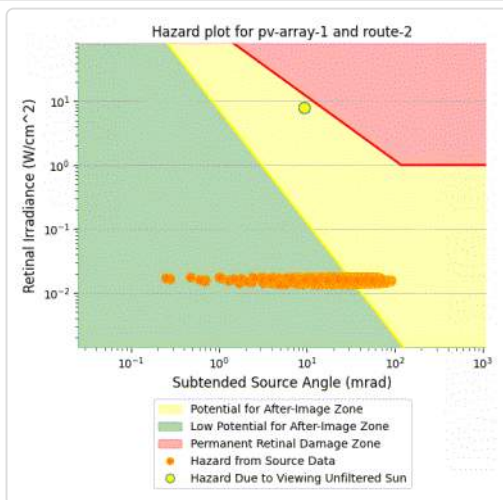
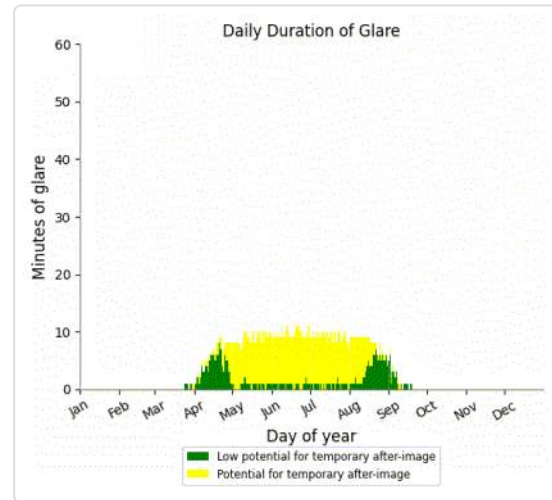
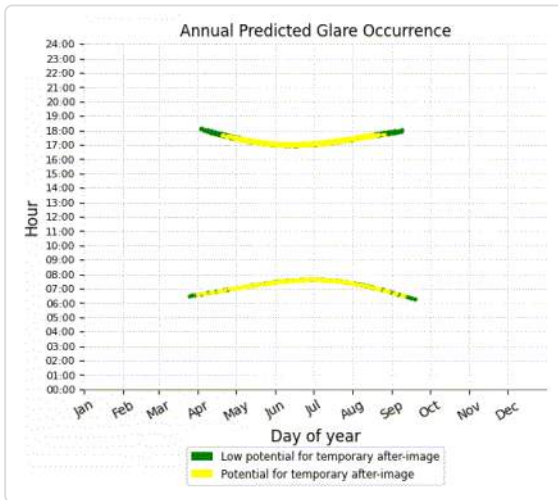

PV array 1 and Route: Route 1

No glare found

ADVERTISED PLAN

This copied document to be made available for the sole purpose of enabling its consideration and review as part of a planning process under the Planning and Environment Act 1987. The document must not be used for any purpose which may breach any copyright

PV array 1 and Route: Route 3

No glare found

PV array 1 and Route: Route 4

No glare found

ADVERTISED PLAN

This copied document to be made available for the sole purpose of enabling its consideration and review as part of a planning process under the Planning and Environment Act 1987. The document must not be used for any purpose which may breach any copyright

ADVERTISED PLAN

PV array 1 and FP: FP 2

Yellow glare: none
Green glare: 263 min.

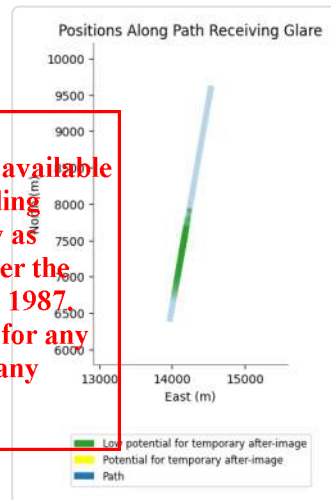
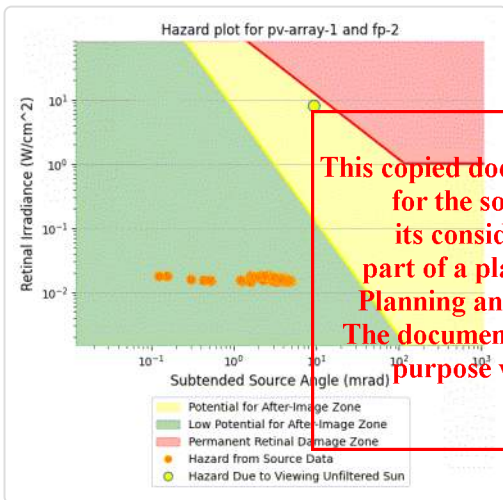
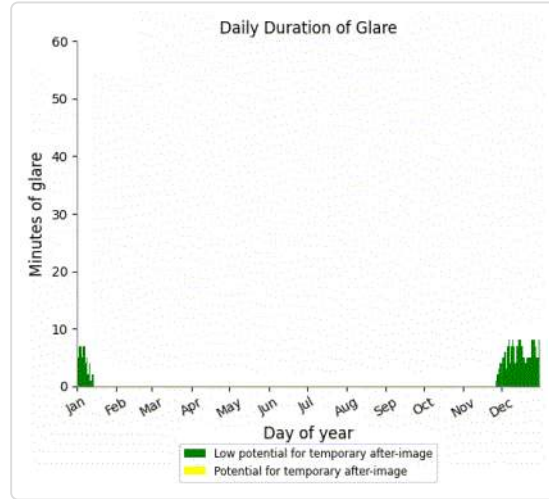
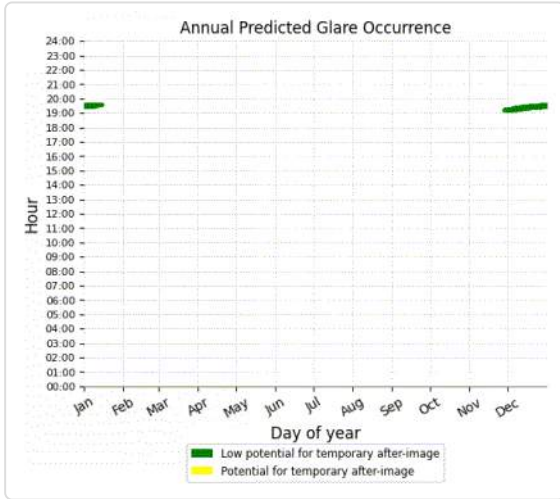

This copied document to be made available for the sole purpose of enabling its consideration and review as part of a planning process under the Planning and Environment Act 1987. The document must not be used for any purpose which may breach any copyright

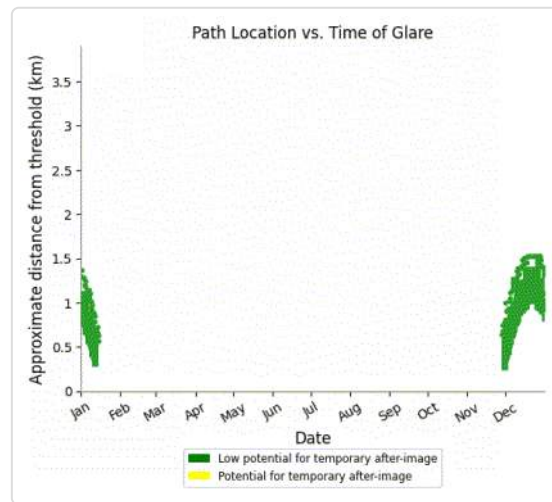
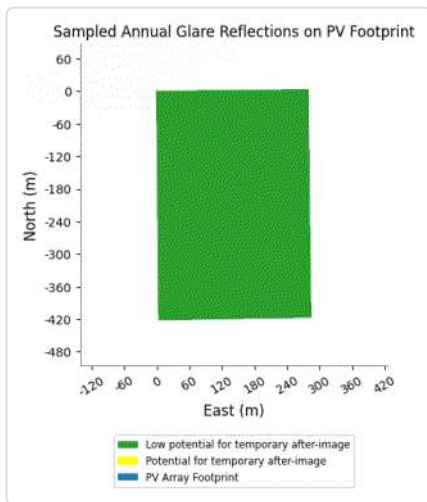

PV array 1 and FP: FP 1

No glare found

PV array 1 and OP 1

Yellow glare: none

Green glare: 318 min.

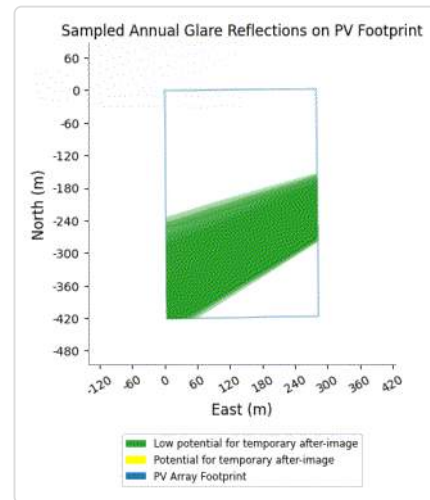
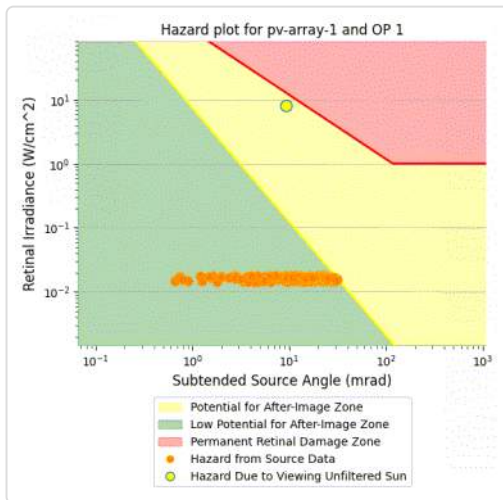
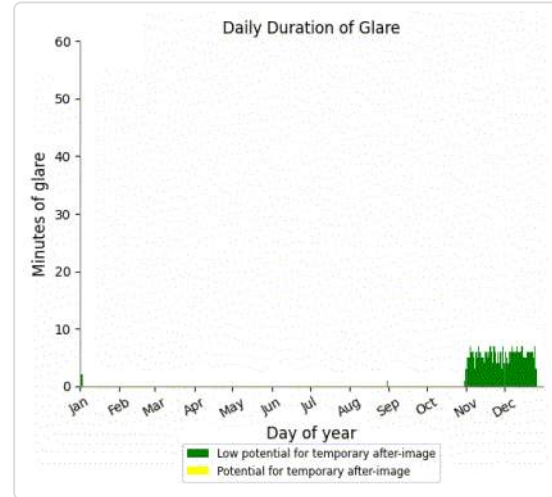
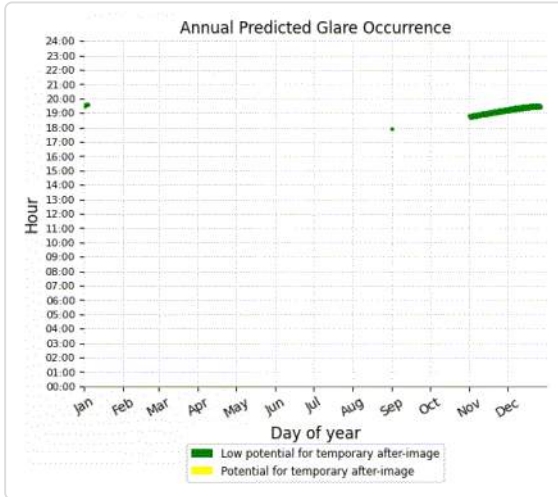

PV array 1 and OP 2

No glare found

PV array 1 and OP 3

No glare found

PV array 1 and OP 4

No glare found

PV array 1 and OP 5

No glare found

PV array 1 and OP 6

No glare found

**ADVERTISED
PLAN**

This copied document to be made available for the sole purpose of enabling its consideration and review as part of a planning process under the Planning and Environment Act 1987. The document must not be used for any purpose which may breach any copyright

PV array 1 and OP 7

No glare found

PV array 1 and OP 8

No glare found

PV array 1 and OP 9

No glare found

PV array 1 and OP 10

No glare found

PV array 1 and OP 11

No glare found

PV array 1 and OP 12

No glare found

PV array 1 and OP 13

No glare found

PV array 1 and OP 14

No glare found

PV array 1 and OP 15

No glare found

PV array 1 and OP 16

No glare found

PV array 1 and OP 17

No glare found

PV array 1 and OP 18

No glare found

PV array 1 and OP 19

No glare found

**ADVERTISED
PLAN**

This copied document to be made available for the sole purpose of enabling its consideration and review as part of a planning process under the Planning and Environment Act 1987. The document must not be used for any purpose which may breach any copyright

Assumptions

"Green" glare is glare with low potential to cause an after-image (flash blindness) when observed prior to a typical blink response time.

"Yellow" glare is glare with potential to cause an after-image (flash blindness) when observed prior to a typical blink response time.

Times associated with glare are denoted in Standard time. For Daylight Savings, add one hour.

The algorithm does not rigorously represent the detailed geometry of a system; detailed features such as gaps between modules, variable height of the PV array, and support structures may impact actual glare results. However, we have validated our models against several systems, including a PV array causing glare to the air-traffic control tower at Manchester-Boston Regional Airport and several sites in Albuquerque, and the tool accurately predicted the occurrence and intensity of glare at different times and days of the year.

Several V1 calculations utilize the PV array centroid, rather than the actual glare spot location, due to algorithm limitations. This may affect results for large PV footprints. Additional analyses of array sub-sections can provide additional information on expected glare. This primarily affects V1 analyses of path receptors.

Random number computations are utilized by various steps of the annual hazard analysis algorithm. Predicted minutes of glare can vary between runs as a result. This limitation primarily affects analyses of Observation Point receptors, including ATCTs. Note that the SGHAT/ ForgeSolar methodology has always relied on an analytical, qualitative approach to accurately determine the overall hazard (i.e. green vs. yellow) of expected glare on an annual basis.

The analysis does not automatically consider obstacles (either man-made or natural) between the observation points and the prescribed solar installation that may obstruct observed glare, such as trees, hills, buildings, etc.

The subtended source angle (glare spot size) is constrained by the PV array footprint size. Partitioning large arrays into smaller sections will reduce the maximum potential subtended angle, potentially impacting results if actual glare spots are larger than the sub-array size. Additional analyses of the combined area of adjacent sub-arrays can provide more information on potential glare hazards. (See previous point on related limitations.)

The variable direct normal irradiance (DNI) feature (if selected) scales the user-prescribed peak DNI using a typical clear-day irradiance profile. This profile has a lower DNI in the mornings and evenings and a maximum at solar noon. The scaling uses a clear-day irradiance profile based on a normalized time relative to sunrise, solar noon, and sunset, which are prescribed by a sun-position algorithm and the latitude and longitude obtained from Google maps. The actual DNI on any given day can be affected by cloud cover, atmospheric attenuation, and other environmental factors.

The ocular hazard predicted by the tool depends on a number of environmental, optical, and human factors, which can be uncertain. We provide input fields and typical ranges of values for these factors so that the user can vary these parameters to see if they have an impact on the results. The speed of SGHAT allows expedited sensitivity and parametric analyses.

The system output calculation is a DNI-based approximation that assumes clear, sunny skies year-round. It should not be used in place of more rigorous modeling methods.

Hazard zone boundaries shown in the Glare Hazard plot are an approximation and visual aid based on aggregated research data. Actual ocular impact outcomes encompass a continuous, not discrete, spectrum.

Glare locations displayed on receptor plots are approximate. Actual glare-spot locations may differ.

Refer to the Help page at www.forgesolar.com/help/ for assumptions and limitations not listed here.

Default glare analysis parameters and observer eye characteristics (for reference only):

- Analysis time interval: 1 minute
- Ocular transmission coefficient: 0.5
- Pupil diameter: 0.002 meters
- Eye focal length: 0.017 meters
- Sun subtended angle: 9.3 milliradians

© Sims Industries d/b/a ForgeSolar, All Rights Reserved.

This copied document to be made available for the sole purpose of enabling its consideration and review as part of a planning process under the Planning and Environment Act 1987. The document must not be used for any purpose which may breach any copyright

**ADVERTISED
PLAN**



This copied document to be made available
for the sole purpose of enabling
its consideration and review as
part of a planning process under the
Planning and Environment Act 1987.
The document must not be used for any
purpose which may breach any
copyright

Appendix E

Cultural Heritage Due Diligence Assessment

This copied document to be made available for the sole purpose of enabling its consideration and review as part of a planning process under the Planning and Environment Act 1987. The document must not be used for any purpose which may breach any copyright

ADVERTISED
PLAN



ADVERTISED
PLAN

Goulburn Valley Water Solar Farm - Tatura

Cultural Heritage Due Diligence Assessment

Goulburn Valley Water

7 December, 2023

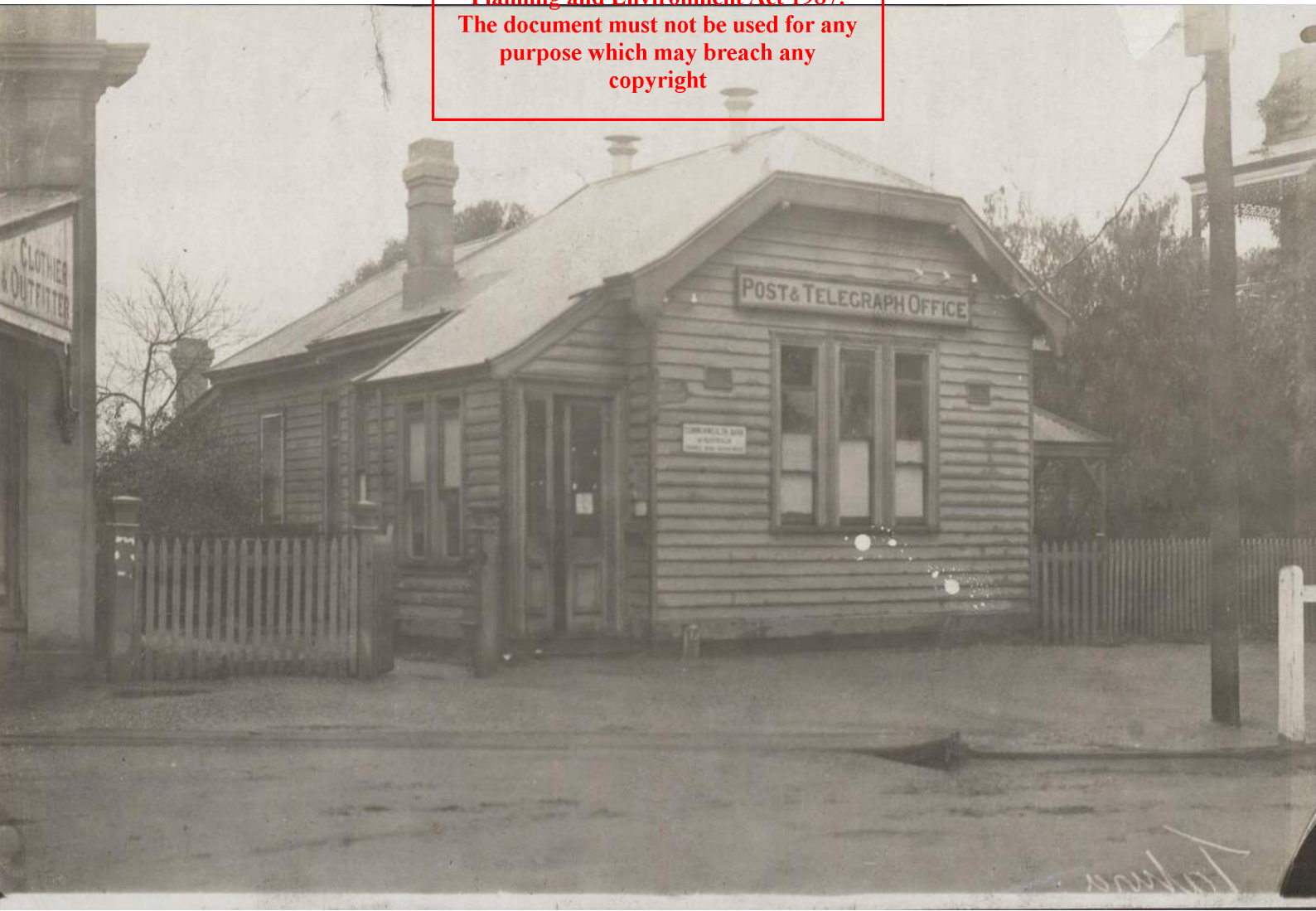

This copied document to be made available for the sole purpose of enabling its consideration and review as part of a planning process under the Planning and Environment Act 1987. The document must not be used for any purpose which may breach any copyright

The Power of Commitment



This copied document to be made available for the sole purpose of enabling its consideration and review as part of a planning process under the Planning and Environment Act 1987. The document must not be used for any purpose which may breach any copyright

ADVERTISED PLAN

Project name		Goulburn Valley Water Solar Farm					
Document title		Goulburn Valley Water Solar Farm - Tatura Cultural Heritage Due Diligence Assessment					
Project number		12579414					
File name		12579414-REP-A-CulturalHeritageDueDiligenceAssessmentCHDDA_Tatura.docx					
Status Code	Revision	Author	Reviewer		Approved for issue		
			Name	Signature	Name	Signature	Date
S3		Glenn McDonald	David Tutchener		Michael Goode		07/12/23

GHD Pty Ltd ABN 39 008 488 373

Level 9, 180 Lonsdale Street

Melbourne, VIC, 3000, Australia

T +61 3 8687 8000 | **F** +61 3 8732 7046 | **E** melmail@ghd.com | **GHD.com**

© GHD 2023

This document is and shall remain the property of GHD. The document may only be used for the purpose for which it was commissioned and in accordance with the Terms of Engagement for the commission. Unauthorised use of this document in any form whatsoever is prohibited.

Executive Summary

Goulburn Valley Water has engaged GHD Pty Ltd (GHD) to undertake a cultural heritage due diligence (CHDDA) assessment of the proposed solar farm development at the Tatura Wastewater Management Facility (WMF) at Dhurringile Road, Tatura, Victoria. The proposed works involve the potential design and delivery of a large-scale solar generation facility.

This CHDDA is being prepared as part of a larger planning permit application.

This CHDDA provides information and advice on heritage considerations for the proposed works. Legislative considerations for the project have been assessed under the *Environment Protection and Biodiversity Conservation Act 1999* (EPBC Act), *Planning and Environment Act 1987*, *Aboriginal Heritage Act 2006*, and *Heritage Act 2017*. This CHDDA is a desktop assessment and does not constitute an approval under the Acts identified above.

This assessment concludes that there are no statutory approvals required for heritage matters under the *Environment Protection and Biodiversity Conservation Act 1999* (EPBC Act), *Planning and Environment Act 1987*, *Aboriginal Heritage Act 2006*, and *Heritage Act 2017*.

The study area's history has been evaluated to assess the potential for archaeological sites within the study area. There are no heritage overlays (HO) within the study area and a planning permit is not required under the *Planning and Environment Act 1987*.

This report is subject to, and must be read in conjunction with, the limitations set out in section 1.5 and the assumptions and qualifications contained throughout the CHDDA. A summary of the findings is presented in Table 1 based on the results of the legislative risk assessments undertaken in sections 3 and 4.

Table 1 Legislative heritage requirements

Act	Requirements
EPBC Act 1999	No approvals for the proposed works are required under the <i>Environment Protection and Biodiversity Conservation Act 1999</i> (EPBC Act) for heritage matters. Please note that this does not include approval requirements under the EPBC Act for any other matters of National Environmental Significance.
Aboriginal Heritage Act 2006	The study area is not within an area of cultural heritage sensitivity (CHS) and is not considered a high impact activity under Regulation 46(3) of the Aboriginal Heritage Regulations 2018. Therefore, a mandatory CHMP is not required. Please note: Under Section 27 and 28 of the Aboriginal Heritage Act 2006, harming Aboriginal cultural heritage is an offence unless it has been permitted under the approval of a cultural heritage permit, cultural heritage management plan or other listed approval mechanism.
Heritage Act 2017 and Planning and Environment Act 1987	No approvals for the proposed works are required under the Heritage Act 2017 or the Planning and Environment act 1987. There are no places listed on the Victorian Heritage Inventory, or the Victorian Heritage Register, and there are no Heritage Overlays present within the study area. Please note, however, any historical heritage over 75 years in age is protected under the Heritage Act 2017, regardless of its recorded status. It is not recommended that further historical heritage investigations be undertaken.

This copied document to be made available for the sole purpose of enabling its consideration and review as part of a planning process under the Planning and Environment Act 1987. The document must not be used for any purpose which may breach any copyright

ADVERTISED PLAN

Contents

	ADVERTISED PLAN	1
Abbreviations		1
1. Introduction		2
1.1 Purpose of this report		2
1.2 Study area		2
1.3 Traditional Owners		2
1.4 Proposed works		2
1.5 Scope and limitations		2
2. Desktop assessment		4
2.1 Statutory context		4
2.1.1 Environment Protection and Biodiversity Conservation Act 1999		4
2.1.2 Aboriginal Heritage Act 2006		4
2.1.3 Heritage Act 2017		4
2.1.4 Planning and Environment Act 1987		5
2.2 Environmental Context		5
2.2.1 Topography		5
2.3 Historical context		5
2.3.1 Ethnohistory		5
2.3.2 Historical settlement		5
2.3.3 Historical land use Before You Dig Australia		6
2.4 Archaeological context		9
2.4.1 Historical heritage place patterning		9
2.4.2 Aboriginal cultural heritage place patterning		10
2.4.3 Previous studies		10
2.5 Summary of desktop assessment		10
3. Aboriginal cultural heritage		12
3.1 Regulatory triggers		12
3.1.1 Area of cultural heritage sensitivity		12
3.1.2 High impact activity		12
3.1.3 Mandatory CHMP requirements		12
3.2 Assessment of risk to Aboriginal cultural heritage		12
3.2.1 Risk assessment		12
4. Historic cultural heritage		13
4.1 Regulatory triggers		13
4.1.1 Environment Protection and Biodiversity Conservation Act		13
4.1.2 Heritage Act 2017		13
4.1.3 Planning and Environment Act 1987		13
4.2 Assessment of risk to historic cultural heritage		13
Policy for determining archaeological value		13
5. Conclusion		15
6. Bibliography		16

This copied document to be made available for the sole purpose of enabling its consideration and review as part of a planning process under the Planning and Environment Act 1987. The document must not be used for any purpose which may breach any copyright

Table index

Table 1	Legislative heritage requirements	i
Table 2	VAHR Aboriginal places within 5km of the study area	10
Table 3	Legislative heritage requirements	15

Figure index

Figure 1	Location of study area with various heritage considerations shown.	3
Figure 2	c.1940 map showing the approximate study area in red (Department of Crown Lands and Survey, 1940).	7
Figure 3	1945 aerial image showing extent of vegetation clearance with the approximate study area in red (Adastra Airways, 1945).	8
Figure 4	Tatura aerial photo map 1971 with project area marked in red (Adastra Airways, 1971)	8
Figure 5	1981 aerial image of the sewage treatment works with the approximate study area in red (Victoria State Rivers and Water Supply Commission, 1981)	9

Appendices

Appendix A	Before You Dig Australia
------------	--------------------------

**ADVERTISED
PLAN**

This copied document to be made available for the sole purpose of enabling its consideration and review as part of a planning process under the Planning and Environment Act 1987. The document must not be used for any purpose which may breach any copyright

Abbreviations

ACHRIS	Aboriginal Cultural Heritage Register and Information Services
BYDA	Before You Dig Australia
CHDDA	Cultural Heritage Due Diligence Assessment
CHL	Commonwealth Heritage List
CHMP	Cultural Heritage Management Plan
CHS	Cultural Heritage Sensitivity
DCCEEW	Department of Climate Change, Energy, the Environment and Water
EPBC Act	<i>Environment Protection and Biodiversity Conservation Act 1999</i>
FP – SR	First Peoples – State Relations
GHD	GHD Pty Ltd
HO	Heritage Overlay
HV	Heritage Victoria
LDAD	Low Density Artefact Distribution
NHL	National Heritage List
SPS	Sewage Pump Station
RAP	Registered Aboriginal Party
VAHR	Victorian Aboriginal Heritage Register
VHI	Victorian Heritage Industry
VHR	Victorian Heritage Register
WHL	World Heritage List
WMF	Wastewater Management Facility

This copied document to be made available for the sole purpose of enabling its consideration and review as part of a planning process under the Planning and Environment Act 1987. The document must not be used for any purpose which may breach any copyright

**ADVERTISED
PLAN**

1. Introduction

Goulburn Valley Water has engaged GHD Pty Ltd (GHD) to undertake a Cultural Heritage Due Diligence Assessment (CHDDA) to inform heritage legislative requirements for the proposed solar farm at the existing Tatura WMF site at Dhurringile Road, Tatura, VIC, 3616. The proposed works the planning, design and delivery of a large-scale solar generation project. The site is owned by GVW and all power generated by the solar facilities will be exported directly to the national electricity transmission network.

1.1 Purpose of this report

This CHDDA provides information and advice on heritage considerations for the proposed works. Legislative considerations for the project have been assessed under the *Environment Protection and Biodiversity Conservation Act 1999* (EPBC Act), *Planning and Environment Act 1987*, *Aboriginal Heritage Act 2006*, and *Heritage Act 2017*.

This CHDDA is a desktop assessment and does not constitute an approval under the Acts identified above.

1.2 Study area

The study area is the existing Tatura WMF to the south of Tatura township bordered to the south by Toolamba Rushworth Lane, and Dhurringile Road to the east. The study area is approximately 150 km northeast of Melbourne. The property is approximately .25km² and contains infrastructure related to the WMF (See Figure 1 below).

1.3 Traditional Owners

The Yorta Yorta Nation Aboriginal Corporation are the Registered Aboriginal Party (RAP) for the study area. It is outside of the scope of this CHDDA to consult with the RAP.

1.4 Proposed works

GVW is seeking to install a large-scale solar facility within its Seymour and/or Tatura WMF sites. Both sites are located within GVW owned land and all power generated by the solar facilities will be exported directly to the national electricity transmission network. GHD anticipates that the potential system sizes to meet the targeted annual electricity generation volume, each system will be approximately 5MW.

1.5 Scope and limitations

This report: has been prepared by GHD for Goulburn Valley Water and may only be used and relied on by Goulburn Valley Water for the purpose agreed between GHD and Goulburn Valley Water as set out in section 1 of this report.

GHD otherwise disclaims responsibility to any person other than Goulburn Valley Water arising in connection with this report. GHD also excludes implied warranties and conditions, to the extent legally permissible.

The services undertaken by GHD in connection with preparing this report were limited to those specifically detailed in the report and are subject to the scope limitations set out in the report.

The opinions, conclusions and any recommendations in this report are based on conditions encountered and information reviewed at the date of preparation of the report. GHD has no responsibility or obligation to update this report to account for events or changes occurring subsequent to the date that the report was prepared.

The opinions, conclusions and any recommendations in this report are based on assumptions made by GHD described in this report (refer section(s) 1 of this report). GHD disclaims liability arising from any of the assumptions being incorrect.

Accessibility of documents

If this report is required to be accessible in any other format, this can be provided by GHD upon request and at an additional cost if necessary.

**ADVERTISED
PLAN**



ADVERTISED PLAN

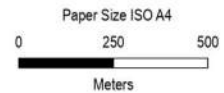

Map Projection: Transverse Mercator
 Horizontal Datum: GDA2020
 Grid: GDA2020 MGA Zone 55



Goulburn Valley Water
 Goulburn Valley Water Solar Farms

Goulburn Valley Water Solar Farms (Tatura)
 Cultural Heritage Due Diligence Assessment

Project No. 12579414
 Revision No. A
 Date 28/11/2023

FIGURE 1

2. Desktop assessment

This desktop assessment examines technical data to establish a high-level cultural, environmental, statutory, archaeological, and historic context for the study area. This context is provided to understand the potential for built, archaeological, and cultural heritage values to be present in the study area and associated heritage risks or legislative obligations for the project.

2.1 Statutory context

2.1.1 Environment Protection and Biodiversity Conservation Act 1999

Commonwealth requirements in relation to environmental (includes heritage) assessment and management are principally specified in the EPBC Act administered by the Commonwealth Department of Climate Change, Energy, the Environment and Water (DCCEEW).

The EPBC Act provides for the listing of natural, historic or Indigenous heritage values on Commonwealth lands, lands under Australian Government control or that are of outstanding heritage value. Listings include the World Heritage List (WHL), National Heritage List (NHL), and Commonwealth Heritage List (CHL).

The EPBC Protected Matters Search Tool was accessed on 13 November 2023. There are no heritage values registered on the WHL, NHL or CHL within the study area.

Please note that this does not include approval requirements under the *EPBC Act* for any other non-heritage MNES.

2.1.2 Aboriginal Heritage Act 2006

The *Aboriginal Heritage Act 2006* and Aboriginal Heritage Regulations 2018 stipulate the requirements for the assessment, management, and protection of Aboriginal heritage in Victoria. Requirements for assessment and approvals relating to Aboriginal heritage linked with the Victorian planning system are regulated by First Peoples – State Relations (FP – SR). FP – SR maintains the Victorian Aboriginal Heritage Register (VAHR), which lists sites containing both tangible and intangible Aboriginal cultural heritage values.

FP – SR maintains a dataset that is a spatial representation of "Areas of Cultural Heritage Sensitivity" (CHS) as specified in Division 3, Part 2 of the Aboriginal Heritage Regulations 2018. Mapping of CHS is continually revised; however, a major update of CHS occurred in May 2018 when the current Regulations came into effect.

The Aboriginal Cultural Heritage Register and Information System (ACHRIS) was searched using access number 12821 on 13 November 2023. There are no registered Aboriginal cultural heritage places within the study area, and the study area is not within an area of cultural heritage sensitivity (CHS) as defined in Division 3 of the Aboriginal Heritage Regulations 2018.

2.1.3 Heritage Act 2017

The *Heritage Act 2017* is the principal legislation covering the assessment, management, and protection of non-Aboriginal heritage in Victoria included on the Victorian Heritage Register. Heritage Victoria (HV) regulates heritage assessment and approvals and administers the Act. HV maintains the Victorian Heritage Register (VHR), which lists items of State significance, and the Victorian Heritage Inventory (VHI), which lists items with significant historic archaeological heritage values.

There are no VHR or VHI places recorded within the study area at the time of the assessment.

This copied document to be made available for the sole purpose of enabling its consideration and review as part of a planning process under the Planning and Environment Act 1987. The document must not be used for any purpose which may breach any copyright

**ADVERTISED
PLAN**

2.1.4 Planning and Environment Act 1987

The *Planning and Environment Act 1987* is the primary legislation for planning the use, development, and management of land in Victoria. The Act includes as an objective of planning in Victoria *to conserve and enhance those buildings, areas or other places which are of scientific, aesthetic, architectural or historical interest, or otherwise of special cultural value*. Planning Schemes provide for the management of items of local heritage significance through Heritage Overlays (HO).

There are no Heritage Overlays that intersect with the study area at the time of the assessment.

2.2 Environmental Context

2.2.1 Topography

The study area is situated at approximately 490 m Australian Height Datum, is 7km west of the nearest major waterway, the Goulburn River. The Goulburn River is one of the major waterways of the region and in this area flows through plains with leveed channels. The study area is situated on the Shepparton Formation geomorphological unit, which is comprised of clay, sand, silt, and gravel. Terraces are sometimes present above river channels, and the area generally contains well developed soil 2-3m thick (GeoVic, 2023).

2.3 Historical context

2.3.1 Ethnohistory

During European colonisation, the region was occupied by clans of the Yorta Yorta People, whose traditional Country encompassed what has become known as the central Murray – Goulburn Region, extending north encompassing both sides of the Murray River, roughly from Cohuna to Albury/Wodonga. Prior to colonisation, clans comprised the basic 'land owning' group in Aboriginal society (Clark I. , 1990). In Victoria, clans were patrilineal descent groups with territories defined by ritual and economic responsibilities.

Clans that shared a common dialect and political and economic interests distinguished themselves from others by the use of a language name (Barwick, 1984). Barwick (1984) and Clark (1990, p. 20) note that Tatura is situated on the lands of the Ngurai-Illam Wurrung group, whose territory extended throughout the Goulburn Valley Region bordered by the Campaspe River, and the towns of Murchison, Mooroopna, and Violet Town. According to Clark, there are three known Ngurai-illam-wurrung Clans; The Benbedora balug occupied the Elmore area, the Gunung willam occupied the Campaspe River and the Ngurai-illam balug were located around Murchison (Clark I. , 1990, p. 364). It has been suggested that the word 'tatura' comes from the Ngurai Illam wurrung word '*tatchera*' has been reported to mean large plain (Clark & Heydon, 2002).

The Victorian Aboriginal Corporation for Languages (VACL) (2023) notes that the Ngurai-Illam Wurrung 'clan' is part of the Yorta Yorta language group, and for the purposes of the Cultural Heritage Due Diligence Assessment, the study area is situated on the lands of the Yorta Yorta People, who are the Registered Aboriginal Party (RAP) for the study area.

2.3.2 Historical settlement

Prior to establishment of Tatura township, the area was a pastoral run held by squatters. Tatura township was proclaimed in March of 1874 and the first land sales took place in January of 1875. The initial development concentrated on the northwest corner of the town later following to the south and south-east (Heritage Concepts, 2010). The town prospered following the introduction of irrigation in 1889 when the Tatura Waterworks Trust was gazette, assisting Tatura to reach a population of 2500 by the year 1890.

This copied document to be made available for the sole purpose of enabling its consideration and review as part of a planning process under the Planning and Environment Act 1987. The document must not be used for any purpose which may breach any copyright

**ADVERTISED
PLAN**

World War 1 impacted the social fabric of Tatura, by initially serving as a recruitment centre for the recruitment trains that came through the area. Horses from the area were also used to support the war effort, and later by settling many returned servicemen on land made available under the *Discharged Soldiers Settlement Act of 1917*. A period of relative prosperity followed World War 1, with the establishment of several industries, including local cannery in 1919, and the continued expansion of irrigated pasture. Tatura again playing a key role following the breakout of World War II as POW internment camps were established near Tatura and Rushworth, where over 250 soldiers were stationed, influencing the social fabric of the town. Military history has had significant influence on the town of Tatura, which is evident in the historical monuments, memorials, and heritage listed places within the Tatura Township, particularly around the Hogan Street area, that became the commercial centre of Tatura following World War 1 (Heritage Concepts, 2010).

Following the Wars, Tatura continued to grow into a pastoral centre of Victoria, aided by post-war migration, the establishment of an increasingly vibrant civil society throughout the 1950s, 60s, and 70s and the growth of agricultural and pastoral industries such as dairy, fruit, and (less so), wool, all heavily reliant on irrigated farmland. Irrigation also resulted in a shift of some industries from seasonal to year-round.

2.3.3 Historical land use

The study area is situated approximately 4.7km south of the centre of Tatura Township, 1km east of the Murchison-Tatura Road. Prior to the construction of the Tatura WMF, the land on which it is situated was primarily pastoral, with little evidence of structural development or buildings. The Sewage Treatment Facility has played an integral role in the town, with treated water contributing to the irrigation networks that support agricultural and pastoral industry in the broader Shepparton/Tatura area.

Goulburn Valley Water became the registered owner of the Tatura WMF site in 1999, prior to which it was owned by the relevant sewerage authority. Infrastructure improvements and expansion has taken place at the site since at least 1979 however, there is no information to suggest that infrastructure that meets the criteria for a historic heritage place registration is likely to be present at the site.

The Tatura Wastewater Management Facility upgrade was initiated in 1999 to enable zero discharge through the construction of additional winter storage, and increased land for irrigation (Hebard & Keir, 2000). Prior to this, emergency discharges were common and caused potential detrimental environmental impacts (Hebard & Keir, 2000).

**This copied document to be made available
for the sole purpose of enabling
its consideration and review as
part of a planning process under the
Planning and Environment Act 1987.
The document must not be used for any
purpose which may breach any
copyright**

**ADVERTISED
PLAN**

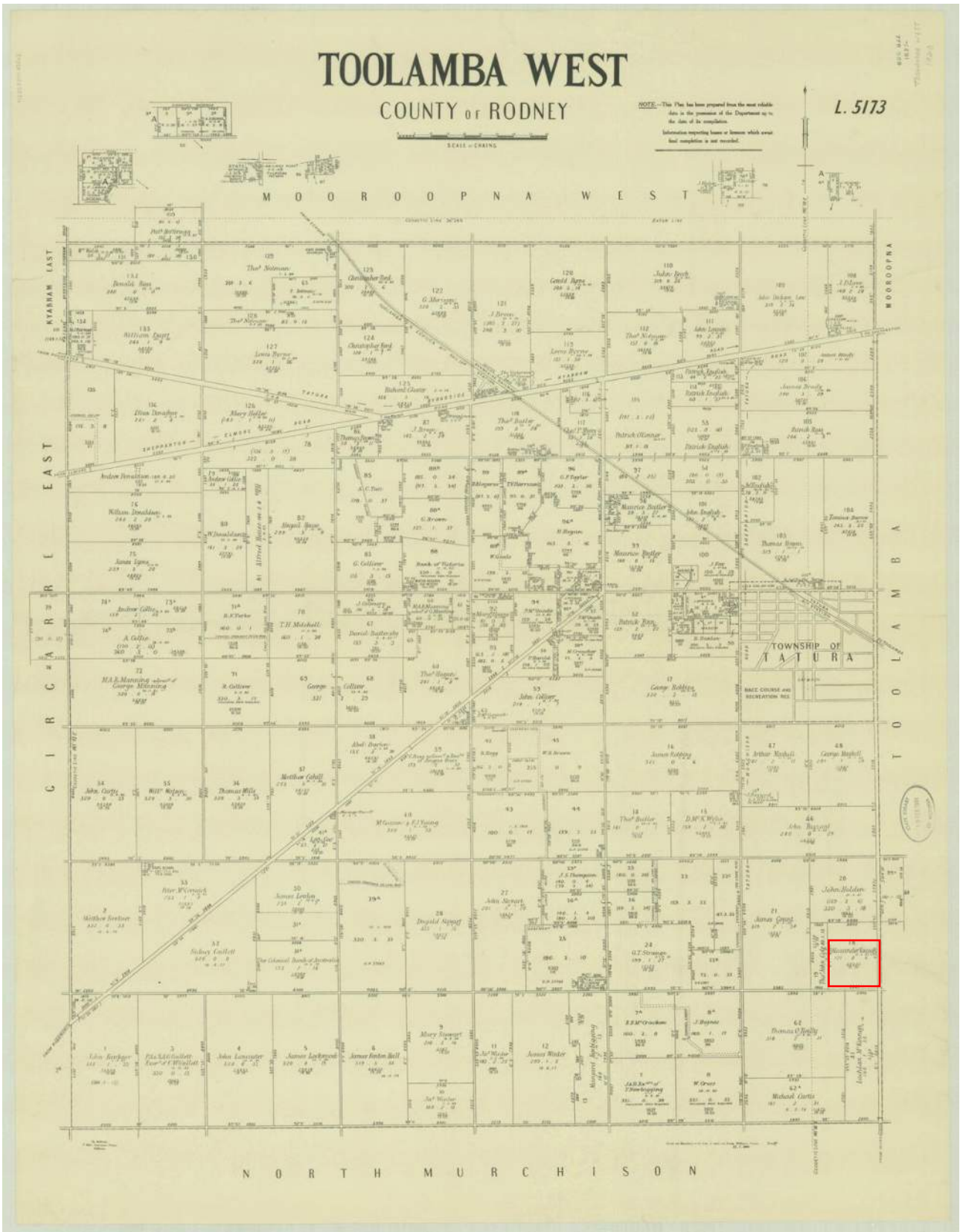

Figure 2 c.1940 map showing the approximate study area in red (Department of Crown Lands and Survey, 1940).

This copied document to be made available for the sole purpose of enabling its consideration and review as part of a planning process under the Planning and Environment Act 1987. The document must not be used for any purpose which may breach any copyright

ADVERTISED PLAN



Figure 3 1945 aerial image showing extent of vegetation clearance with the approximate study area in red (Adastra Airways, 1945).



Figure 4 Tatura aerial photo map 1971 with project area marked in red (Adastra Airways, 1971)

This copied document to be made available for the sole purpose of enabling its consideration and review as part of a planning process under the Planning and Environment Act 1987. The document must not be used for any purpose which may breach any copyright

ADVERTISED PLAN



Figure 5 1981 aerial image of the sewage treatment works with the approximate study area in red (Victoria State Rivers and Water Supply Commission, 1981)

Before You Dig Australia

A Before You Dig Australia search was undertaken on 21 September 2023 in order to document the presence of subsurface utilities and services that may have had an impact on the ground surfaces within the study area. The following services are located within the study area and documented in Appendix A:

- Telstra: The Telstra report shows that there are cables and pits located along the eastern edge of the project area, and in the south-eastern corner.
- Citipower Powercor: Citipower Powercor report shows underground electrical infrastructure within the south-eastern corner of the project area.
- NBN: NBN showed that there is NBN infrastructure located in the south-east corner and eastern edge of the project area.
- Goulburn Valley Water: The Goulburn Valley Water Report notes that there are high-risk assets located along the eastern edge of the project area.

This copied document to be made available for the sole purpose of enabling its consideration and review as part of a planning process under the Planning and Environment Act 1987. The document must not be used for any purpose which may breach any copyright.

2.4 Archaeological context

2.4.1 Historical heritage place patterning

There are no known historical sites registered on the VHR or VHI within the study area and there are no Heritage Overlays that intersect with the study area.

There are no VHR or VHI sites within 4km of the study area, with the nearest being the Tatura WWII internment and POW camp on the corner of Hogan and Ross Streets within Tatura Township.

The majority of Heritage Overlays within the Tatura township are related to early colonial built heritage related to the development of Tatura township. These are generally distributed within the centre of Tatura, where development spread from. The historical land use assessment has shown no evidence of similar buildings within the study area.

The desktop assessment's land use history and aerial imagery shows that the Tatura WMF covered the area to the north of the study area from 1971 and appears to extend to within the study area by 1981. Prior to this the area was cleared of vegetation since at least 1945, and no prior waterways or major geographic features intersect with the study area.

ADVERTISED
PLAN

ADVERTISED PLAN

2.4.2 Aboriginal cultural heritage place patterning

ACHRIS was searched on 27 September 2023 in order to obtain a better understanding of known Aboriginal places in the area, what types they were, and how this could inform assessment of the study area. There are no VAHR registered Aboriginal places within the study area. There are three registered Aboriginal places within 5km of the study area which are both scarred trees. This suggests that it is unlikely that Aboriginal heritage is located within the study area.

Table 2 VAHR Aboriginal places within 5km of the study area

VAHR site name	Site number	Component Type
CRAVEN RD 2	7925-0443-1	Scarred Tree
CRAVEN RD 1	7925-0442-1	Scarred Tree
STEWART RD 4	7925-0261-1	Scarred Tree

2.4.3 Previous studies

There have not been any Cultural Heritage Management Plans within 500 m of the study area which can inform the likelihood of Aboriginal heritage within the study area however Archaeological Consulting Services (2005) conducted a useful study into the Central Goulburn (CG) 1234 Channel System near Tatura that offers useful insights into the broader cultural landscape.

The report notes the long history of grazing and cropping in the area surrounding the CH 1234 Channel System, particularly in relation to its impacts on Aboriginal heritage. The report notes that Scarred trees would have likely been removed for timber or agricultural purposes, and that surface sites such as oven mounds and middens would have been disturbed by extensive pastoral and agricultural activities. (Archaeological Consulting Services, 2005, p. 16).

2.5 Summary of desktop assessment

The study area is the existing Tatura WMF to the south of Tatura township bordered to the south by Toolamba Rushworth Lane, and Dhurringile Road to the east and is situated approximately 150 km northeast of Melbourne. The property is approximately 25km² and contains infrastructure related to the Tatura WMF.

The Aboriginal Cultural Heritage Register and Information System (ACHRIS) was searched using access number 12821 on 13 November 2023. There are no registered Aboriginal cultural heritage places within the study area, and the study area is not within an area of cultural heritage sensitivity (CHS) as defined in Division 3 of the Aboriginal Heritage Regulations 2018.

The Yorta Yorta Nation Aboriginal Corporation are the Registered Aboriginal Party (RAP) for the study area. It is outside of the scope of this CHDDA to consult with the RAP.

Tatura township was proclaimed in March of 1874 and the first land sales took place in January of 1875. The initial development concentrated on the northwest corner of the town later following to the south and south-east (Heritage Concepts, 2010). Prior to the construction of the Tatura WMF, the land on which it is situated was primarily pastoral, with little evidence of structural development or buildings. The Sewage Treatment Facility has played an integral role in the town, with treated water contributing to the irrigation networks that support agricultural and pastoral industry in the broader Shepparton/Tatura area.

Analysis of registered heritage sites in and around the Tatura township has been used to estimate the historic place patterning within the study area at Tatura WMF. The majority of heritage sites in the Tatura township relate to built heritage and early buildings relating to the settlement and development of the town, and are generally distributed within the centre of Tatura, particularly around Hogan Street. The historical land use assessment has shown no evidence of similar buildings within the study area. Early maps indicate the study area was farmland until the Tatura WMF was constructed in 19XX. Because of this it is unlikely that heritage predating construction of the c.19XX sewage treatment plant would be located within the study area.

Analysis of previous archaeological assessments and registered Aboriginal places near to the study area has been used to assess Aboriginal place patterning. There are three registered Aboriginal places within 5km of the study area which are both scarred trees. Previous assessments of the area suggest that Aboriginal places are more likely to be found on elevated land features adjacent to waterways. This suggests that it is unlikely that Aboriginal heritage is located within the study area.

ADVERTISED PLAN

**This copied document to be made available
for the sole purpose of enabling
its consideration and review as
part of a planning process under the
Planning and Environment Act 1987.
The document must not be used for any
purpose which may breach any
copyright**

3. Aboriginal cultural heritage

This section assesses legislative obligations and risk management options for Aboriginal heritage.

3.1 Regulatory triggers

Under the Aboriginal Heritage Regulations 2018, Regulation 7, a mandatory CHMP is required if the activity is located in an area of CHS and is classified as a high impact activity.

3.1.1 Area of cultural heritage sensitivity

According to the Aboriginal Heritage Regulations 2018, the study area is not within an area of CHS.

3.1.2 High impact activity

The proposed works include the construction of a solar energy generation facility, which is a high impact activity under Regulation 46(1)(b)(xxvii) as utility installation.

46 Buildings and works for specified uses

- (1) The construction of a building or the construction or carrying out of works on land is a high impact activity if the construction of the building or the construction or carrying out of the works –
 - (a) Would result in significant ground disturbance; and
 - (b) Is for, or associated with, the use of the land for any one or more of the following purposes –
 - (xxvii) a utility installation, other than a telecommunications facility, if –
- (2) The terms used in subregulation (1)(b) have the same meaning as they have in the Victorian Planning Provisions.
- (3) Despite Subregulation (1), the construction of a building or the construction or carrying out of work on land is not a high impact activity if it is for, or associated with, a purpose listed under subregulation (1)(b) for which the land was being lawfully used immediately before 28 May 2007.

3.1.3 Mandatory CHMP requirements

The project does not trigger the Mandatory CHMP requirements as it is not within an area of cultural heritage sensitivity.

3.2 Assessment of risk to Aboriginal cultural heritage

3.2.1 Risk assessment

Under Sections 27 and 28 of the *Aboriginal Heritage Act 2006*, it is an offence to knowingly or negligently harm, or undertake an act that is likely to cause harm, to Aboriginal cultural heritage. The likelihood of causing harm to potentially unrecorded Aboriginal cultural heritage within the study area therefore needs to be assessed.

There are no VAHR registered Aboriginal places within the study area. Previous CHMPs in the area have identified that areas adjacent to waterways are more sensitive to Aboriginal cultural heritage and as the study area is over 3.5km from the nearest major waterway, and contains no significant landforms relevant to Aboriginal heritage, it is considered unlikely that Aboriginal heritage is present within the study area.

This copied document to be made available for the sole purpose of enabling its consideration and review as part of a planning process under the Planning and Environment Act 1987. The document must not be used for any purpose which may breach any copyright

**ADVERTISED
PLAN**

4. Historic cultural heritage

This section assesses legislative obligations and risk management options for historic (non-Aboriginal) heritage.

4.1 Regulatory triggers

Regulatory triggers for heritage approvals under the EPBC Act, *Heritage Act 2017* and *Planning and Environment Act 1987* are documented below.

4.1.1 Environment Protection and Biodiversity Conservation Act

Approvals are required under the EPBC Act if:

- A proposed action is likely to have a significant impact on a matter of national environmental significance; or
- If the proposed action likely to have a significant impact on the environment in general (for actions by Commonwealth agencies or actions on Commonwealth land) or the environment on Commonwealth land (for actions outside Commonwealth land)

A search of the EPBC Protected Matters Search Tool has indicated that there are no heritage places registered on the WHL, NHL or CHL within the study area. The proposed works are not located on Commonwealth Land. No approvals under the EPBC Act are required for heritage matters.

4.1.2 Heritage Act 2017

Under the *Heritage Act 2017*, a permit or permit exemption is required to change any place or object listed on the VHR. The Act also requires a Consent for any actions that will uncover, excavate or damage an archaeological site listed on the VHI. There are no historical archaeological sites registered on the VHR or VHI within the study area.

4.1.3 Planning and Environment Act 1987

There are no Heritage Overlay within the study area under the Mitchell Planning Scheme and no requirements for approvals relating to heritage matters under the *Planning and Environment Act 1987*.

4.2 Assessment of risk to historic cultural heritage

Under the *Heritage Act 2017* (3)(1) an archaeological site includes a place that contains an artefact, deposit or feature which is 75 years or more years old. Archaeological sites are protected under the *Heritage Act 2017* and require consent to damage, uncover, or otherwise impact the site.

Policy for determining archaeological value

With the introduction of the *Heritage Act 2017*, the VHI transitioned from listing all known historical archaeological sites to listing only archaeological sites that met a threshold for inclusion. Under the *Heritage Act 2017*, an archaeological site is defined as a place (other than a shipwreck) which:

- Contains an artefact, deposit or feature which is 75 years or more old; and
- Provides information of past activity in the State; and
- Requires archaeological methods to reveal information about settlement, development or use of the place; and
- Is not associated only with Aboriginal occupation of the place

This copied document to be made available for the sole purpose of enabling its consideration and review as part of a planning process under the Planning and Environment Act 1987. The document must not be used for any purpose which may breach any copyright

**ADVERTISED
PLAN**

Under the *Heritage Act 2017*, the VHI records all archaeological sites other than those which have been determined by the Executive Director to have low archaeological value. HV have released a Policy for Determining Low Archaeological Value (2017), which provides two thresholds which must be met for an archaeological site to have more than low archaeological value. These thresholds are:

Threshold A (archaeology):

- The place meets the definition of an archaeological site under the Act; and
- It can be demonstrated that the site contains archaeological features, associated artefacts and/or deposits; and/or
- Documentary evidence and/or oral history, landscape features, visible site fabric or other information indicates a likelihood that the site contains archaeological remains; and
- The archaeological remains are, or are likely to be, in a condition that will allow information to be obtained that will contribute to an understanding of the site

Threshold B (place history):

- The site evidences (or is likely to evidence) an association with a historical event, phase, period, process, function, tradition, movement, custom or way of life; and
- The site history is of significance within a state, regional, local, thematic, or other relevant framework

Historic archaeological potential

An examination of the previous land use indicates that the land where the Tatura WMF is currently located has primarily been pastoral land (see image above). The majority of the historical places in Tatura are associated with early town infrastructure and early buildings within the township itself.

Due to the lack of buildings and infrastructure situated on the Tatura WMF site that are associated with the early development of the town, there is low potential for historic archaeological places to be situated within the study area.

**ADVERTISED
PLAN**

This copied document to be made available for the sole purpose of enabling its consideration and review as part of a planning process under the Planning and Environment Act 1987. The document must not be used for any purpose which may breach any copyright

5. Conclusion

This section of the report summarises findings and makes recommendations to ensure the proposed works legislative compliance and to manage heritage risk. The recommendations are based on the results of the legislative risk assessments undertaken in section 3 and 4 and are summarised in Table 3 below.

Table 3 Legislative heritage requirements

Act	Requirements
EPBC Act 1999	No approvals for the proposed works are required under the <i>Environment Protection and Biodiversity Conservation Act 1999</i> (EPBC Act) for heritage matters. Please note that this does not include approval requirements under the EPBC Act for any other matters of National Environmental Significance.
Aboriginal Heritage Act 2006	The study area is not within an area of cultural heritage sensitivity (CHS) and is not considered a high impact activity under Regulation 46(3) of the Aboriginal Heritage Regulations 2018. Therefore, a mandatory CHMP is not required. <i>Please note: Under Section 27 and 28 of the Aboriginal Heritage Act 2006, harming Aboriginal cultural heritage is an offence unless it has been permitted under the approval of a cultural heritage permit, cultural heritage management plan or other listed approval mechanism.</i>
Heritage Act 2017 and Planning and Environment Act 1987	No approvals for the proposed works are required under the Heritage Act 2017 or the Planning and Environment act 1987. There are no places listed on the Victorian Heritage Inventory, or the Victorian Heritage Register, and there are no Heritage Overlays present within the study area. <i>Please note, however, any historical heritage over 75 years in age is protected under the Heritage Act 2017, regardless of its recorded status. It is not recommended that further historical heritage investigations be undertaken.</i>

This copied document to be made available for the sole purpose of enabling its consideration and review as part of a planning process under the Planning and Environment Act 1987. The document must not be used for any purpose which may breach any copyright

**ADVERTISED
PLAN**

6. Bibliography

Adastra Airways. (1945). *Shepparton C4 or 789 C4*. Retrieved from Map Share Historical Photo-Maps Index: <https://mapshare.vic.gov.au/webmap/historical-photomaps/>

Adastra Airways. (1971). *Shepparton C4 or 789C4*. Retrieved from Map Share Historical Photo-Maps index: <https://mapshare.vic.gov.au/webmap/historical-photomaps>

Archaeological Consulting Services. (2005, January). *Cultural Heritage Assessment CG1234 Channel System, Near Tatura, Northeast Victoria*. Mildura: Archaeological Consulting Services.

Barwick, D. (1984). Mapping the past: an atlas of Victorian Clans 1835 - 1904. *Aboriginal History*, 8, 100-132.

Clark, I. (1990). *Aboriginal Language and Clans: An Historical Atlas of Western and Central Victoria 1800-1900*. Melbourne: Department of Geography and Environmental Science, Monash University.

Clark, I. D., & Heydon, T. (2002). *Dictionary of Aboriginal Placenames in Victoria*. Melbourne: Victorian Aboriginal Corporation for Languages.

Department of Crown Lands and Survey. (1940). Toolamba West Parish Map. Melbourne. Retrieved from State Library Victoria.

GeoVic. (2023, November 23). *Resources Victoria - GeoVic*. Retrieved from Geovic: <https://resources.vic.gov.au/geology-exploration/maps-reports-data/geovic>

Hebard, V., & Keir, G. (2000). Issues for Reclaimed Water Re-use at Tatura WWTP. *63rd Annual Water Industry Engineers and Operators' Conference*, (pp. 59-67). Warrnambool.

Heritage Concepts. (2010). *Volume 2: Greater Shepparton City Council Heritage Study Stage IIB: Tatura Contextual History*. Shepparton: Greater Shepparton City Council.

Heritage Victoria. (2017). *Policy for determining low archaeological value*. Victoria: Heritage Victoria.

Victoria State Rivers and Water Supply Commission. (1981). Tatura Photomap 1:25000 series . Melbourne, Victoria, Australia.

Victorian Aboriginal Corporation for Languages. (2023, Nov 22). *Victorian Aboriginal Corporation for Languages*. Retrieved from <https://www.vacl.org.au/language/yorta-yorta/>

**This copied document to be made available
for the sole purpose of enabling
its consideration and review as
part of a planning process under the
Planning and Environment Act 1987.
The document must not be used for any
purpose which may breach any
copyright**

**ADVERTISED
PLAN**

Appendix A

Before You Dig Australia

This copied document to be made available for the sole purpose of enabling its consideration and review as part of a planning process under the Planning and Environment Act 1987. The document must not be used for any purpose which may breach any copyright

ADVERTISED
PLAN



Job No 35460873

Phone: 1100
www.byda.com.au

Caller Details

Contact: Glenn McDonald **Caller Id:** 3475497 **Phone:** 0401 826 531
Company: GHD
Address: Level 9 180 Lonsdale Street **Email:** glenn.mcdonald@ghd.com
Melbourne VIC 3000

Dig Site and Enquiry Details

WARNING: The map below only displays the location of the proposed dig site and does not display any asset owners' pipe or cables. The area highlighted has been used only to identify the participating asset owners, who will send information to you directly.



User Reference: Job #12579414 (Tatura)
Working on Behalf of: Private
Enquiry Date: 13/11/2023 **Start Date:** 27/11/2023 **End Date:** 01/07/2024
Address: 765 Dhurringile Road, Toolamba West VIC 3614
Job Purpose: Design **Onsite Activities:** Planning & Design
Location of Workplace: Private **Location in Road:**

- Check that the location of the dig site is correct. If not you must submit a new enquiry.
- Should the scope of works change, or plan validity dates expire, you must submit a new enquiry.
- Do NOT dig without plans. Safe excavation is your responsibility. If you do not understand the plans how to proceed, contact the relevant asset owners.

This copied document to be made available for the description of works enabling its consideration and review as part of a planning process under the Planning and Environment Act 1987. The document must not be used for any purpose which may breach any copyright.

ADVERTISED PLAN

Your Responsibilities and Duty of Care

- The lodgement of an enquiry does not authorise the project to commence. You must obtain all necessary information from any and all likely impacted asset owners prior to excavation.
- If plans are not received within 2 working days, contact the asset owners directly & quote their Sequence No.
- ALWAYS perform an onsite inspection for the presence of assets. Should you require an onsite location, contact the asset owners directly. Please remember, plans do not detail the exact location of assets.
- Pothole to establish the exact location of all underground assets using a hand shovel, before using heavy machinery.
- Ensure you adhere to any State legislative requirements regarding Duty of Care and safe digging requirements.
- If you damage an underground asset you MUST advise the asset owner immediately.
- By using this service, you agree to Privacy Policy and the terms and disclaimers set out at www.byda.com.au
- **For more information on safe excavation practices, visit www.byda.com.au**

Asset Owner Details

The assets owners listed below have been requested to contact you with information about their asset locations within 2 working days. Additional time should be allowed for information issued by post. It is **your responsibility** to identify the presence of any underground assets in and around your proposed dig site. Please be aware, that not all asset owners are registered with the Before You Dig service, so it is **your responsibility** to identify and contact any asset owners not listed here directly.

** Asset owners highlighted by asterisks ** require that you visit their offices to collect plans.
Asset owners highlighted with a hash # require that you call them to discuss your enquiry or to obtain plans.

Seq. No.	Authority Name	Phone	Status
232072251	APA Group Gas Networks (70303)	1800 085 628	NOTIFIED
232072252	Goulburn Valley Water	1800 454 500	NOTIFIED
232072253	Greater Shepparton City Council	(03) 5832 9828	NOTIFIED
232072248	NBN Co VicTas	1800 687 626	NOTIFIED
232072250	Powercor - Shepparton	13 22 06	NOTIFIED
232072249	Telstra VICTAS	1800 653 935	NOTIFIED

END OF UTILITIES LIST

Lodge Your Free Enquiry Online - 24 Hours a Day, Seven Days a Week

Cable Plan

This copied document to be made available for the sole purpose of enabling its consideration and review as part of a planning process under the Planning and Environment Act 1987. The document must not be used for any purpose which may breach any copyright

ADVERTISED PLAN

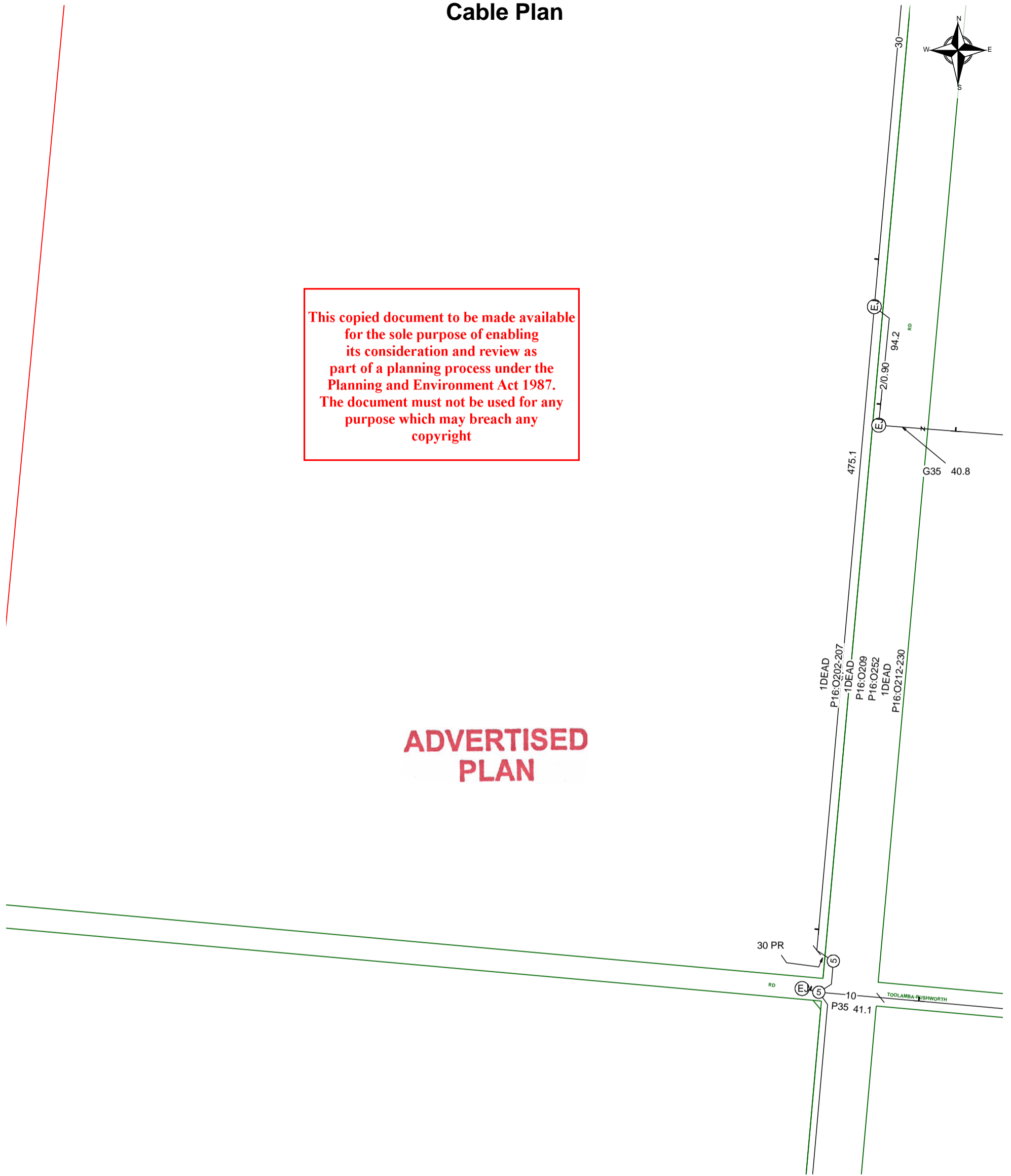

Report Damage: <https://service.telstra.com.au/customer/general/forms/report-damage-to-telstra-equipment>
 Ph - 13 22 03
 Email - Telstra.Plans@team.telstra.com
 Planned Services - ph 1800 653 935 (AEST bus hrs only) General Enquiries

TELSTRA LIMITED A.C.N. 086 174 781

Generated On 13/11/2023 16:07:07

Sequence Number: 232072249

Please read Duty of Care prior to any excavating

WARNING

Telstra plans and location information conform to Quality Level "D" of the Australian Standard AS 5488-Classification of Subsurface Utility Information.

As such, Telstra supplied location information is indicative only. Spatial accuracy is not applicable to Quality Level D.

Refer to AS 5488 for further details. The exact position of Telstra assets can only be validated by physically exposing it.

Telstra does not warrant or hold out that its plans are accurate and accepts no responsibility for any inaccuracy.

Further on site investigation is required to validate the exact location of Telstra plant prior to commencing construction work.

A Certified Locating Organisation is an essential part of the process to validate the exact location of Telstra assets and to ensure the asset is protected during construction works.

See the Steps- Telstra Duty of Care that was provided in the email response.



OPENING ELECTRONIC MAP ATTACHMENTS -

Telstra Cable Plans are generated automatically in either PDF or DWF file types dependant on the site address and the size of area selected. You may need to download and install free viewing software from the internet e.g.



PDF Map Files (max size A3)

Adobe Acrobat Reader (<http://get.adobe.com/reader/>),



DWF Map Files (all sizes over A3)

Autodesk Viewer (Browser) (<https://viewer.autodesk.com/>) or

Autodesk Design Review (<http://usa.autodesk.com/design-review/>) for DWF files. (Windows)



Telstra BYDA map related enquiries

email - Telstra.Plans@team.telstra.com

1800 653 935 (AEST Business Hours only)

This copied document to be made available for the sole purpose of enabling its consideration and review as part of a planning process under the Planning and Environment Act 1987. The document must not be used for any purpose which may breach any copyright



REPORT ANY DAMAGE TO THE TELSTRA NETWORK IMMEDIATELY

Report online - <https://www.telstra.com.au/forms/report-damage-to-telstra-equipment>

Ph: 13 22 03

If you receive a message asking for a phone or account number say:

“I don’t have one” then say “Report Damage” then press 1 to speak to an operator.



Telstra New Connections / Disconnections

13 22 00

ADVERTISED PLAN

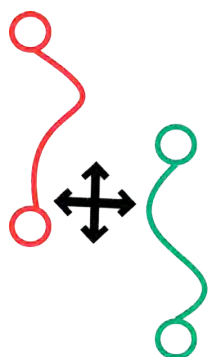

Telstra asset relocation enquiries: 1800 810 443 (AEST business hours only).

NetworkIntegrity@team.telstra.com

<https://www.telstra.com.au/consumer-advice/digging-construction>

Certified Locating Organisation (CLO)

<https://dbydlocator.com/certified-locating-organisation/>

Please refer to attached Accredited Plant Locator.pdf

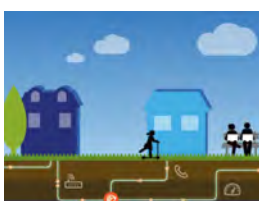

Telstra Smart Communities

Information for new developments (developers, builders, homeowners)

<https://www.telstra.com.au/smart-community>

LEGEND



For more info contact a [Certified Locating Organisation](#) or Telstra Plan Services 1800 653 935

	Exchange (Major Cable Present)		Cable Jointing Pit (number / Letter indicating Pit Type)
	Footway Access Chamber (can vary from 1-lid to 12-lid)		Elevated Joint (above ground joint on buried cable)
	Pillar / Cabinet (above ground / free standing)		Telstra Plant in shared Utility trench
	Above ground complex equipment housing (eg RIM) Please Note: This equipment is powered by 240V Electricity		Aerial Cable / Overhead (includes on wall)
	Other Carrier Telecommunications Cable/Asset		Aerial Cable (attached to joint Use Pole eg. Power)
	Distribution cables in Main Cable ducts Main Cable ducts on a Distribution plan Blocked or damaged duct.		Direct Buried Cable
	Roadside / Front Boundary 2 pair lead-in to property from pit in street 1 O59 pair working (pair ID 059) 1 DEAD 1 pair dead (i.e. spare, not connected) Side / Rear Property Boundary Property Number		Marker Post Installed
	Single to multiple round conduit Configurations 1,2,4,9 respectively (attached text denotes conduit type and size)		Buried Transponder
	Multiple square conduit Configurations 2, 4, 6 respectively (attached text denotes conduit type and size)		Marker Post, Transponder
			Optical Fibre cable direct buried

Some examples of conduit type and size:

A - Asbestos cement, P - PVC / Plastic, C - Concrete,
GI - Galanised iron, E - Earthenware
Conduit sizes *nominally* range from 20mm to 100mm
P50 50mm PVC conduit
P100 100mm PVC conduit
A100 100mm asbestos cement conduit

Some Examples of how to read Telstra Plans

Diagram 1: 50-pair cable in P50 conduit between two pits (6). Dimensions: 10m depth, 20.0m length.

Diagram 2: Two separate conduit runs between two footway access chambers (manholes) approximately 245m apart. One run contains a nest of four 100mm PVC conduits (P100) containing assorted cables in three ducts (one being empty) and one empty 100mm concrete duct (C100).

WARNING: Telstra plans and location information conform to Quality Level 'D' of the Australian Standard AS 5488 - Classification of Subsurface Utility Information. As such, Telstra supplied location information is indicative only. Spatial accuracy is not applicable to Quality Level D. Refer to AS 5488 for further details. Telstra does not warrant or hold out that its plans are accurate and accepts no responsibility for any inaccuracy shown on the plans. FURTHER ON SITE INVESTIGATION IS REQUIRED TO VALIDATE THE EXACT LOCATION OF TELSTRA PLANT PRIOR TO COMMENCING CONSTRUCTION WORK. A plant location service is an essential part of the process to validate the exact location of Telstra assets and to ensure the assets are protected during construction works. The exact position of Telstra assets can only be validated by physically exposing them. Telstra will seek compensation for damages caused to its property and losses caused to Telstra and its customers.

ADVERTISED
PLAN

This copied document to be made available for the sole purpose of enabling its consideration and review as part of a planning process under the Planning and Environment Act 1987. The document must not be used for any purpose which may breach any copyright



Before You Dig Australia

Think before you dig

This copied document to be made available for the sole purpose of enabling its consideration and review as part of a planning process under the Planning and Environment Act 1987. The document must not be used for any purpose which may breach any copyright

This document has been sent to you because you requested plans of the Telstra network through Before You Dig Australia (BYDA).

If you are working or excavating near telecommunications cables, or there is a chance that cables are located near your site, you are responsible to avoid causing damage to the Telstra network.

Please read this document carefully. Taking your time now and following the steps below can help you avoid damaging our network, interrupting services, and potentially incurring civil and criminal penalties.

Our network is complex and working near it requires expert knowledge. Do not attempt these activities if you are not qualified to do so.

**ADVERTISED
PLAN**

ADVERTISED PLAN



1. Plan

Plan your work with the latest plans of our network.

Plans provided through the BYDA process are indicative only*.

This means the actual location of our asset may differ substantially from that shown on the plans.

Refer to steps 2 and 3 to determine actual location prior to proceeding with construction.



2. Prepare

Engage a DBYD Certified Locating Organisation (CLO) via dbydlocator.com to identify, validate and protect Telstra assets before you commence work.



3. Pothole

Validate underground assets by potholing by hand or using non-destructive vacuum extraction methods.

Electronic detection alone (step 2) is not deemed to validate underground assets and must not be used for construction purposes.

If you cannot validate the Telstra network, you must not proceed with construction.

This copied document to be made available for the sole purpose of enabling its consideration and review as part of an asset by potholing the Planning and Environment Act 1987. The document must not be used for any purpose which may breach any copyright.



4. Protect

Protect our network by maintaining the following distances from our assets:

- › 1.0m Mechanical Excavators, Farm Ploughing, Tree Removal
- › 500mm Vibrating Plate or Wacker Packer Compactor
- › 600mm Heavy Vehicle Traffic (over 3 tonnes) not to be driven across Telstra ducts or plant
- › 1.0m Jackhammers/Pneumatic Breakers
- › 2.0m Boring Equipment (in-line, horizontal and vertical)



5. Proceed

You can proceed with your work only once you have completed all the appropriate preparation, potholing and protection.

Report any damage immediately



<https://www.telstra.com.au/forms/report-damage-to-telstra-equipment>



13 22 03

If you receive a message asking for an account or phone number say "I Don't have one" Then say "Report Damage" then press 1 to speak to an operator.

Relocating assets

If your project requires the relocation of a Telstra asset, please contact the Telstra Network Integrity Group:



RequestAssetRelocation@team.telstra.com



NetworkIntegrity@team.telstra.com



1800 810 443 (AEST business hours only)

This copied document to be made available for the sole purpose of enabling its consideration and review as part of a planning process under the Planning and Environment Act 1987. The document must not be used for any purpose which may breach any copyright

Never try to move or alter our network infrastructure without authorisation. By law, only authorised people can work on our assets or enter a facility owned or operated by us. Any interference, including unauthorised entry or tampering, may result in legal action.

Further information

Plan enquiries



1800 653 935 (AEST business hours only)



Telstra.Plans@team.telstra.com

Information on how to find cables and request asset relocations:

<https://www.telstra.com.au/consumer-advice/digging-construction>

Asset Plan Readers

PDF [Adobe Acrobat Reader DC Install for all versions](#)

DWF [Download Design Review | DWF Viewer | Autodesk](#)

**ADVERTISED
PLAN**

Disclaimer and legal details



*Telstra advises that the accuracy of the information provided by Telstra conforms to Quality Level D as defined in AS5488-2013.

It is a criminal offence under the Criminal Code Act 1995 (Cth) to tamper or interfere with telecommunications infrastructure.

Telstra will also take action to recover costs and damages from persons who damage assets or interfere with the operation of Telstra's networks.

By receiving this information including the indicative plans that are provided as part of this information package you confirm that you understand and accept the risks of working near Telstra's network and the importance of taking all of the necessary steps to confirm the presence, alignments and various depths of Telstra's network. This in addition to, and not in replacement of, any duties and obligations you have under applicable law.

When working in the vicinity of a telecommunications plant you have a "Duty of Care" that must be observed. Please read and understand all the information and disclaimers provided below.

The Telstra network is complex and requires expert knowledge to interpret information, to identify and locate components, to pothole underground assets for validation and to safely work around assets without causing damage. If you are not an expert and/or qualified in these areas, then you must not attempt these activities. Telstra will seek compensation for damages caused to its property and losses caused to Telstra and its customers. The 5 P's to prevent damage to Telstra assets are listed above. Construction activities and/or any activities that potentially may impact on Telstra's assets must not commence without first undertaking these steps. Construction activities can include anything that involves breaking ground, potentially affecting Telstra assets.

If you are designing a project, it is recommended that you also undertake these steps to validate underground assets prior to committing to your design.

This Notice has been provided as a guide only and may not provide you with all the information that is required for you to determine what assets are on or near your site of interest. You will also need to collate and understand all of the information received from other Utilities and understand that some Utilities are not a part of the BYDA program and make your own enquiries as appropriate. It is the responsibility of the entities undertaking the works to protect Telstra's network during excavation / construction works.

Telstra owns and retains the copyright in all plans and details provided in conjunction with the applicant's request. The applicant is authorised to use the plans and details only for the purpose indicated in the applicant's request. The applicant must not use the plans or details for any other purpose.

Telstra plans or other details are provided only for the use of the applicant, its servants, agents, or Certified Locating Organisation. The applicant must not give the plans or details to any parties other than these and must not generate profit from commercialising the plans or details.

Telstra, its servants or agents shall not be liable for any loss or damage caused or occasioned by the use of plans and or details so supplied to the applicant, its servants and agents, and the applicant agrees to indemnify Telstra against any claim or demand for any such loss or damage.

Please ensure Telstra plans and information provided always remains on-site throughout the inspection, location, and construction phase of any works.

Telstra plans are valid for 60 days after issue and must be replaced if required after the 60 days.

This copy document to be made available for the sole purpose of enabling its consideration and review as part of a planning process under the Planning and Environment Act 1987. The document must not be used for any purpose which may breach any copyright

Data Extraction Fees

In some instances, a data extraction fee may be applicable for the supply of Telstra information. Typically, a data extraction fee may apply to large projects, planning and design requests or requests to be supplied in non-standard formats. For further details contact Telstra Planned Services.

Telstra does not accept any liability or responsibility for the performance of or advice given by a Certified Locating Organisation. Certification is an initiative taken by Telstra towards the establishment and maintenance of competency standards. However, performance and the advice given will always depend on the nature of the individual engagement.

Neither the Certified Locating Organisation nor any of its employees are an employee or agent for Telstra. Telstra is not liable for any damage or loss caused by the Certified Locating Organisation or its employees.

Once all work is completed, the excavation should be reinstated with the same type of excavated material unless specified by Telstra

The information contained within this pamphlet must be used in conjunction with other material supplied as part of this request for information to adequately control the risk of potential asset damage.

When using excavators and other machinery, also check the location of overhead power lines.

Workers and equipment must maintain safety exclusion zones around power lines

WARNING: Telstra plans and location information conform to Quality Level 'D' of the Australian Standard AS 5488 - Classification of Subsurface Utility Information. As such, Telstra supplied location information is indicative only. Spatial accuracy is not applicable to Quality Level D. Refer to AS 5488 for further details. Telstra does not warrant or hold out that its plans are accurate and accepts no responsibility for any inaccuracy shown on the plans. FURTHER ON SITE INVESTIGATION IS REQUIRED TO VALIDATE THE EXACT LOCATION OF TELSTRA PLANT PRIOR TO COMMENCING CONSTRUCTION WORK. A plant location service is an essential part of the process to validate the exact location of Telstra assets and to ensure the assets are protected during construction works. The exact position of Telstra assets can only be validated by physically exposing them. Telstra will seek compensation for damages caused to its property and losses caused to Telstra and its customers.

Privacy Note

Your information has been provided to Telstra by BYDA to enable Telstra to respond to your BYDA request. Telstra keeps your information in accordance with its privacy statement. You can obtain a copy at www.telstra.com.au/privacy or by calling us at 1800 039 059 (business hours only).

ADVERTISED
PLAN



Certified Locating Organisations (CLO)

Find the closest CLO to your worksite on: <https://dbydlocator.com/certified-locating-organisation/>

Read the disclaimer and click:

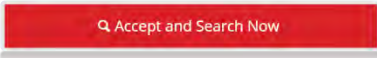

A national map and an A-Z list of Certified Locating Organisations is displayed.

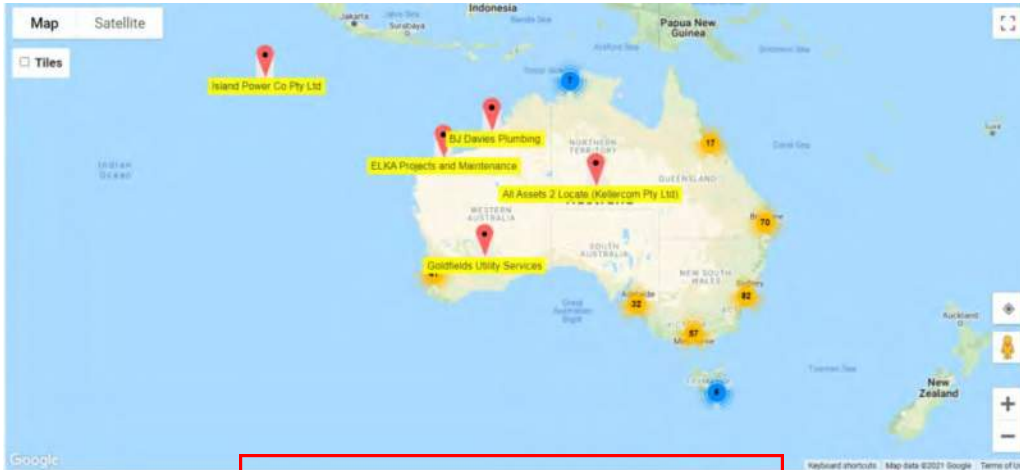

This copied document to be made available for the sole purpose of enabling its consideration and reviews part of a planning process under the Planning and Environment Act 1987. The document must not be used for any purpose which may breach any copyright

Use the map to zoom to your work area and choose the closest Locator indicated.

OR search by entering the postcode of your work area.

1. Enter the post/zip code
2. Choose your search radius
3. Click filter (If there is no result, you may have to increase the search radius)
4. Click on the closest Locator for CLO details or view the results displayed below the map

Only valid while employed by:
TEST COMPANY DCL



L-27000
Anne Locator



Expires: 01/01/2030

CERTIFIED LOCATING ORGANISATION

Locator skills have been tested, and the Organisation has calibrated location and safety equipment.

Telstra is aware of each Certified Locating Organisation and their employee locators.

Only a DBYD Certified Locator registered with a Certified Locating Organisation is authorised to access Telstra network for locating purposes.

Each Certified Locator working for a CLO is issued with a photo ID Card, authorising them to access Telstra pits and manholes for the purpose of cable and plant locations.

Please ask to see your Locators' CLO ID Card.

ADVERTISED PLAN



CitiPower Pty
 ABN 76 064 651 056
www.citipower.com.au

Head Office: 40 Market Street
 Telephone: (03) 9683 4444 Facsimile: (03) 9683 4499 DX 433 Melbourne
 Postal Address: Locked Bag 14090 Melbourne Victoria 8001 Australia



Powercor Australia
 ABN 89 064 651 109
www.powercor.com.au

13/11/2023

Glenn McDonald
 GHD
 Level 9,180 Lonsdale Street
 Melbourne VIC 3000

Reference Number 232072250



Dear Customer

Thankyou for your enquiry on 13/11/2023 regarding the work at: 765 Dhurringile Road, Toolamba West

A SEARCH OF OUR RECORDS SHOWS THAT THERE ARE UNDERGROUND ELECTRICITY ASSETS WITHIN THE AREA OF YOUR REQUEST

DO NOT PROCEED UNTIL YOU HAVE READ THIS NOTICE IN FULL

The following information is attached for your reference:

- Underground Electricity Asset location details
- Underground Electricity Hazard Awareness Instructions

To ensure that your proposed works do not impact on your safety or our assets please proceed as follows:

- Read all attached documents and observe the Exclusion Zones defined in the
- Underground Electricity Hazard Awareness Instructions
- Identify the locations of our Underground Electricity Assets from the attached documents

Are our Underground Electricity Assets located where you are planning to dig?

YES - contact us for further advice. Contact details are available on the first page of the attached Underground

Electricity Hazard Awareness Instructions (including **Request for Site Visit**)

NO - proceed with caution

UNSURE - contact us for further advice. Contact details are available on the first page of the attached Underground Electricity Hazard Awareness Instructions (including **Request for Site Visit**)

Please note that **no work is to be undertaken in the vicinity of our Underground Electricity Assets that may breach the Exclusion Zones** (as defined by the Underground Electricity Hazard Awareness Instructions) until the completion of a further technical assessment of the area.

Upon receipt of your **Request for Site Visit** form you will be contacted by a responsible officer to assess your requirements. A site visit will be organised if required. During the site visit we will determine the location of our assets and any Permit to Work conditions applicable to your works. We will also be able to provide further details of any additional works which may be required to enable you to safely complete your proposed works.

Please note that the Permit to Work site visit timeframes are subject to enquiry volumes and specific site locations, therefore it may require up to 10 working days to contact you and arrange a site visit

Regards, CitiPower & Powercor Dial Before You Dig (DBYD) response team

**ADVERTISED
 PLAN**



Dial Before You Dig (DBYD) Electrical Asset Location Information

CitiPower/Powercor

Locked Bag 14090, Melbourne VIC 8001

General Enquiries Telephone: 132 206

**ADVERTISED
PLAN**

To: ('Enquirer')

Glenn McDonald

Level 9,180 Lonsdale Street

Melbourne VIC 3000

Enquiry Details

Utility ID	50025
Sequence Number	232072250
Enquiry Date	13/11/2023
Response	DANGER - Permit May Be Required
Address	765 Dhurringile Road Toolamba West, VIC 3014
Location in Road	
Activity	Planning & Design

This copied document to be made available for the sole purpose of enabling consideration and review as part of a planning process under the Planning and Environment Act 1987. The document must not be used for any purpose which may breach any copyright

Enquirer Details

Customer ID	3475497
Contact	Glenn McDonald
Company	GHD
Email	wwbw7btvh7yl70.v4ktsx9wfwe9js@smarterwx-mail.1100.com.au
Phone	+61401826531

Enquirer Responsibilities

This notification is valid for 28 days from the issue date. CitiPower/Powercor assets are critical infrastructure and great care must be taken to avoid asset damage and risk to public safety. The information supplied in the DBYD Response is intended to be indicative only. External parties should make their own enquiries to ensure the accuracy of the information, including but not limited to:

- Check that the location of the dig site indicated is correct, if not you must submit a new enquiry.
- Should your scope of works change or the plan validity dates expire, you must submit a new enquiry.
- If you do not understand the plans provided please contact CitiPower/Powercor prior to works commencing.
- Always perform an onsite inspection to establish the presence of assets.
- Ensure you adhere to any State legislative requirements regarding Duty of Care and safe digging requirements.

Report any asset damage immediately on 132 206. Note: CitiPower/Powercor reserves the right to recover compensation for damages.

UNDERGROUND SERVICE CABLE RECORD

CUSTOMER NAME <u>G.V. WATER</u>	FILE NO. <u>416-1402</u>
PHONE NUMBER	POWERCOR CONTACT PERSON <u>Geoff Hall</u>
STREET <u>Rushworth-Tookamba Road</u>	PHONE NUMBER
TOWN <u>TATURA</u>	JOB NUMBER C8N..... F/C
	FEEDER <u>MNA-14</u>

MATERIAL LIST

PIT1..... EA	5975 257 9973	COVER SLAB2..... EA	5340 450 8328	2X 16 6145 200 2341
LID1..... EA	5680 258 1590	GUARD STEEL1..... EA	5975 915 0779	3X 16 6145 200 2363
BEND EA	5975 985 7287	BLACK POLY (3M)3..... M	4710 207 2972	4X 16 6145 200 2374	1.2m
CONDUIT ORANGE1..... LGTH	5975 094 4922				4X 35 6145 262 2114
						4X 50 6145 258 1271

Target Date: 19/8/98

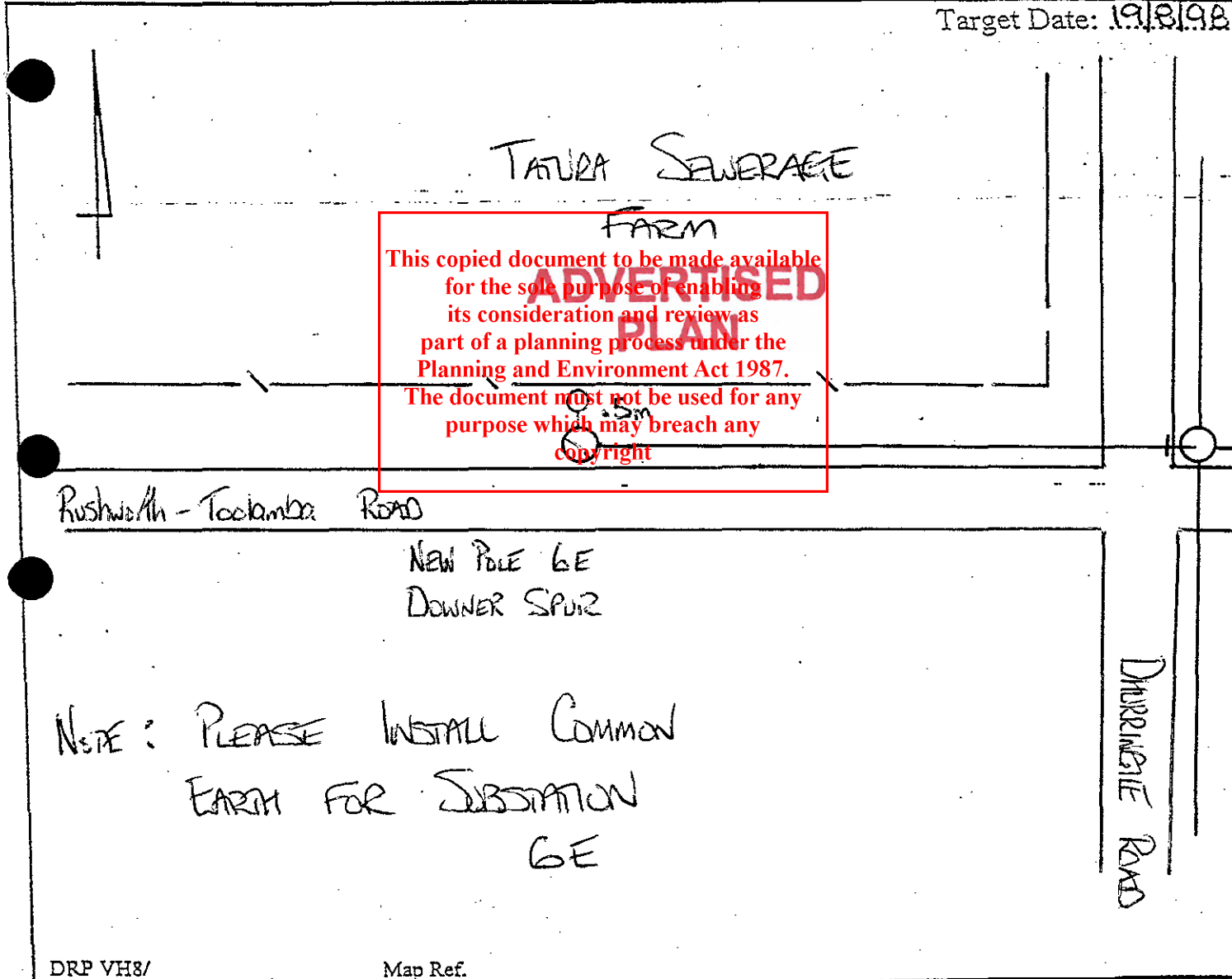

DRP VH8/ Map Ref.

	DATE	INIT.		DATE	INIT.		DATE	INIT.
COMPUTER INPUT	MATERIAL RECD	INV. RECD.
STOREMAN NOTIFIED	INSTALLED	AUTHORISED
ISSUED TO						

**This copied document to be made available
for the sole purpose of enabling
its consideration and review as
part of a planning process under the
Planning and Environment Act 1987.
The document must not be used for any
purpose which may breach any
copyright**

To: Glenn McDonald
Phone: Not Supplied
Fax: Not Supplied
Email: glenn.mcdonald@ghd.com













Dial before you dig Job #:	35460873	
Sequence #	232072248	
Issue Date:	13/11/2023	
Location:	765 Dhurringile Road , Toolamba West , VIC , 3614	

Indicative Plans

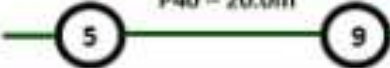
1	5
2	6
3	7
4	8

**ADVERTISED
PLAN**

ADVERTISED PLAN

LEGEND	
	
	Parcel and the location
	Pit with size "5"
	Power Pit with size "2E". Valid PIT Size: e.g. 2E, 5E, 6E, 8E, 9E, E, null.
	Manhole
	Pillar
<p>2 PO – T- 25.0m P40 – 20.0m</p> 	<p>Cable count of trench is 2. One "Other size" PVC conduit (PO) owned by Telstra (-T-), between pits of size "5" and "9" are 25.0m apart. One "Other size" PVC conduit (P40) owned by NBN, between pits of sizes, "5" and "9" are 20.0m apart.</p>
<p>2 10.0m</p> 	2 Direct buried cables between pits of sizes, "5" and "9" are 10.0m apart.
	Trench containing any INSERVICE/CONSTRUCTED (Copper/RF/Fibre) cables.
	Trench containing only DESIGNED/PLANNED (Copper/RF/Fibre/Power) cables.
	Trench containing any INSERVICE/CONSTRUCTED (Power) cables.
	Road and the street name "Broadway ST"
Scale	<p>0 20 40 60 Meters 1:2000 1 cm equals 20 m</p> 

This copied document to be made available for the sole purpose of enabling its consideration and review as part of a planning process under the Planning and Environment Act 1987. The document must not be used for any purpose which may breach any copyright.

1

**ADVERTISED
PLAN**

**This copied document to be made available
for the sole purpose of enabling
its consideration and review as
part of a planning process under the
Planning and Environment Act 1987.
The document must not be used for any
purpose which may breach any
copyright**

2

**ADVERTISED
PLAN**

**This copied document to be made available
for the sole purpose of enabling
its consideration and review as
part of a planning process under the
Planning and Environment Act 1987.
The document must not be used for any
purpose which may breach any
copyright**

3

**ADVERTISED
PLAN**

**This copied document to be made available
for the sole purpose of enabling
its consideration and review as
part of a planning process under the
Planning and Environment Act 1987.
The document must not be used for any
purpose which may breach any
copyright**

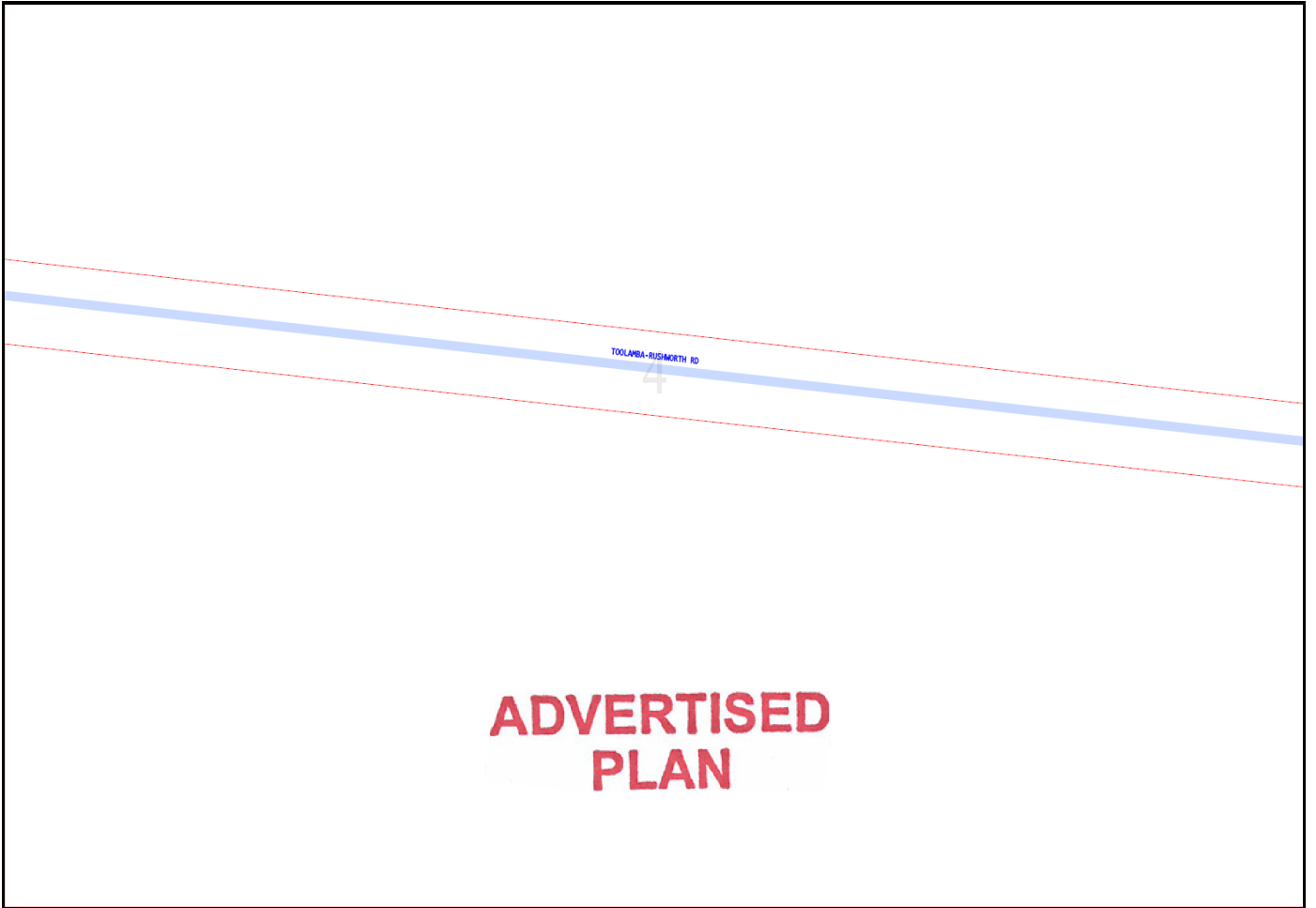

**This copied document to be made available
for the sole purpose of enabling
its consideration and review as
part of a planning process under the
Planning and Environment Act 1987.
The document must not be used for any
purpose which may breach any
copyright**

5

ADVERTISED PLAN

CHARLESTON RD

100-100

100

**This copied document to be made available
for the sole purpose of enabling
its consideration and review as
part of a planning process under the
Planning and Environment Act 1987.
The document must not be used for any
purpose which may breach any
copyright**

6

ADVERTISED PLAN

Ⓢ

UNWAP

765

SP12.10m

**This copied document to be made available
for the sole purpose of enabling
its consideration and review as
part of a planning process under the
Planning and Environment Act 1987.
The document must not be used for any
purpose which may breach any
copyright**

7

**ADVERTISED
PLAN**

DRUMMOND RD

**This copied document to be made available
for the sole purpose of enabling
its consideration and review as
part of a planning process under the
Planning and Environment Act 1987.
The document must not be used for any
purpose which may breach any
copyright**

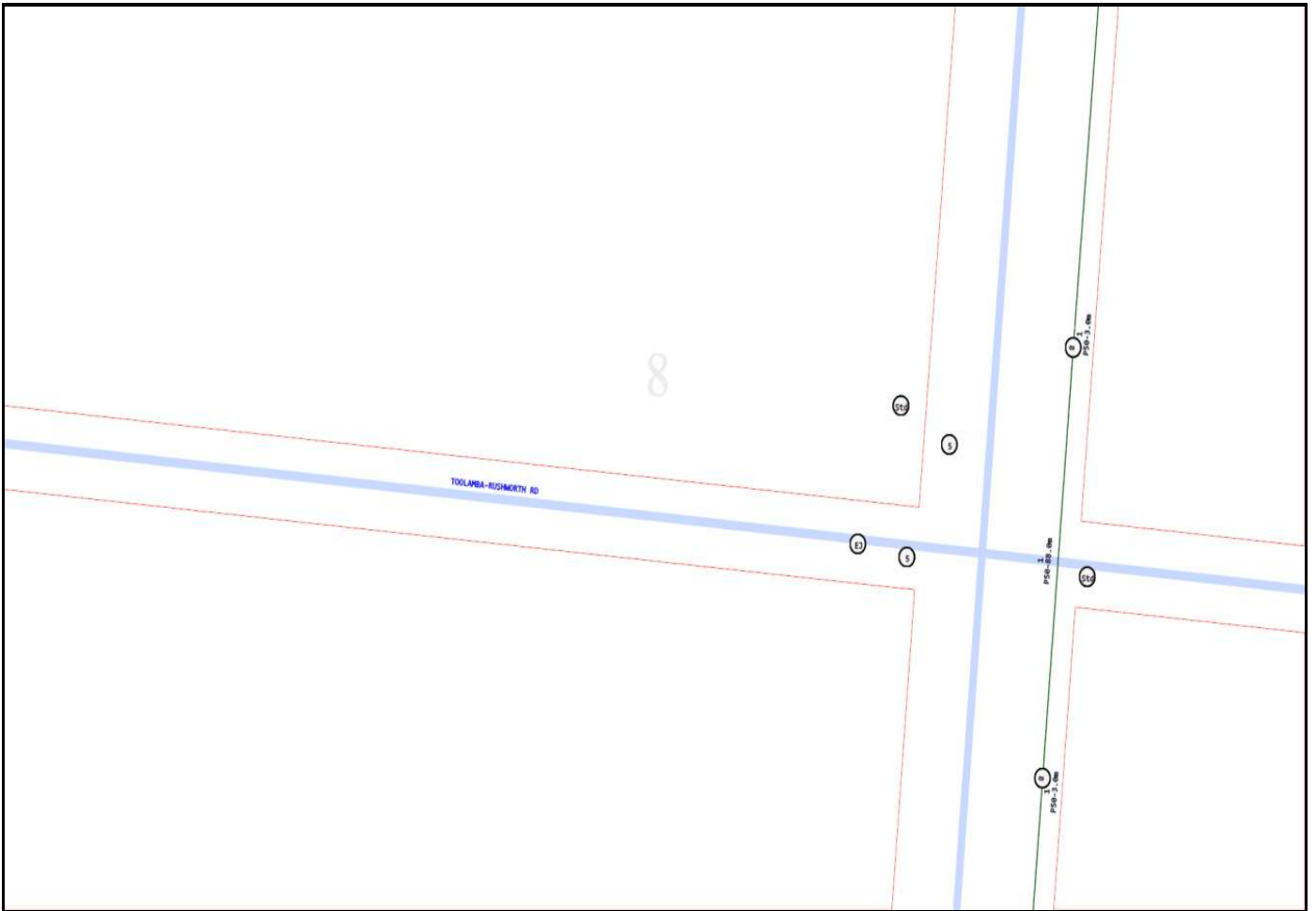

Emergency Contacts

You must immediately report any damage to the **nbn**TM network that you are/become aware of. Notification may be by telephone - 1800 626 329.

**ADVERTISED
PLAN**

This copied document to be made available for the sole purpose of enabling its consideration and review as part of a planning process under the Planning and Environment Act 1987. The document must not be used for any purpose which may breach any copyright



Working near nbn™ cables

nbn has partnered with Dial Before You Dig to give you a single point of contact to get information about **nbn** underground services owned by **nbn** and other utility/service providers in your area including communications, electricity, gas and other services. Contact with underground power cables and gas services can result in serious injury to the worker, and damage and costly repairs. You must familiarise yourself with all of the Referral Conditions (meaning the referral conditions referred to in the DBYD Notice provided by **nbn**).

This copied document to be made available for the sole purpose of enabling users to obtain the DBYD Notice as part of a planning process under the Planning and Environment Act 1987. The document must not be used for any purpose which may breach any copyright

Practice safe work habits

Once the DBYD plans are reviewed, the Five P's of Excavation should be adopted in conjunction with your safe work practices (which must be compliant with the relevant state Electrical Safety Act and Safe Work Australia "Excavation Work Code of Practice", as a minimum) to ensure the risk of any contact with underground **nbn** assets are minimised.



Plan: Plan your job by ensuring the plans received are current and apply to the work to be performed. Also check for any visual cues that may indicate the presence of services not covered in the DBYD plans.



Prepare: Prepare for your job by engaging a DBYD Certified Plant Locator to help interpret plans and identify on-site assets. Contact **nbn** should you require further assistance.

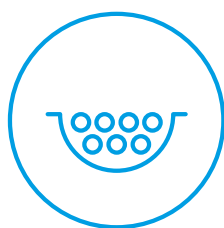

Pothole: Non-destructive potholing (i.e. hand digging or hydro excavation) should be used to positively locate **nbn** underground assets with minimal risk of contact and service damage.

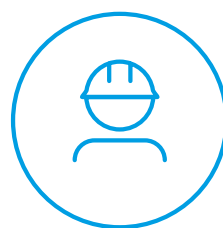

Protect: Protecting and supporting the exposed **nbn** underground asset is the responsibility of the worker. Exclusion zones for **nbn** assets are clearly stated in the plan and appropriate controls must be implemented to ensure that encroachment into the exclusion zone by machinery or activities with the potential to damage the asset is prevented.

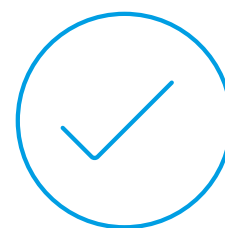

Proceed: Proceed only when the appropriate planning, preparation, potholing and protective measures are in place.

**ADVERTISED
PLAN**

Working near nbn™ cables

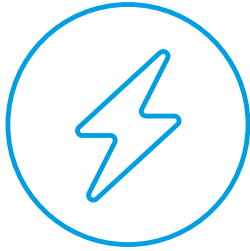

Identify all electrical hazards, assess the risks and establish control measures.

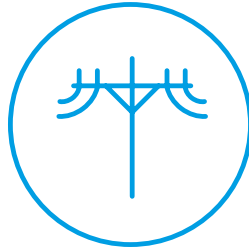

When using excavators and other machinery, also check the location of overhead power lines.

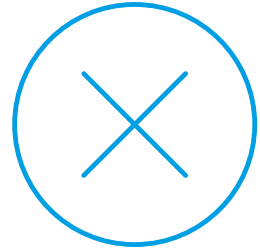

Workers and equipment must maintain safety exclusion zones around power lines.

Once all work is completed, the excavation should be re-instated with the same type of excavated material unless specified by nbn. Please note:

- Construction Partners of nbn may require additional controls to be in place when performing excavation activities.
- The information contained within this pamphlet must be used in conjunction with other material supplied as part of this request for information to adequately control the risk of potential asset damage.

This copied document to be made available for the sole purpose of enabling its consideration and review as part of a planning process under the Planning and Environment Act 1987. The document must not be used for any purpose which may breach any copyright

ADVERTISED PLAN

Contact

All nbn™ network facility damages must be reported online [here](#). For enquiries related to your DBYD request please call 1800 626 329.

Disclaimer

This brochure is a guide only. It does not address all the matters you need to consider when working near our cables. You must familiarise yourself with other material provided (including the Referral Conditions) and make your own inquiries as appropriate.

nbn will not be liable or responsible for any loss, damage or costs incurred as a result of reliance on this brochure.

This document is provided for information purposes only. This document is subject to the information classification set out on this page. If no information classification has been included, this document must be treated as UNCLASSIFIED, SENSITIVE and must not be disclosed other than with the consent of nbn co. The recipient (including third parties) must make and rely on their own inquiries as to the currency, accuracy and completeness of the information contained herein and must not use this document other than with the consent of nbn co. Copyright © 2021 nbn co limited. All rights reserved.



ADVERTISED PLAN

This copied document to be made available for the sole purpose of enabling its consideration and review as part of a planning process under the Planning and Environment Act 1987. The document must not be used for any purpose which may breach any copyright

To: Glenn McDonald
Phone: Not Supplied
Fax: Not Supplied
Email: glenn.mcdonald@ghd.com

Dial before you dig Job #:	35460873	
Sequence #	232072248	
Issue Date:	13/11/2023	
Location:	765 Dhurringile Road , Toolamba West , VIC , 3614	

Information

The area of interest requested by you contains one or more assets.

nbn™ Assets	Search Results
Communications	Asset identified
Electricity	No assets

In this notice **nbn™ Facilities** means *underground fibre optic, telecommunications and/or power facilities, including but not limited to cables, owned and controlled by nbn™*

Location of nbn™ Underground Assets

We thank you for your enquiry. In relation to your enquiry at the above address:

- **nbn's** records indicate that there **ARE nbn™** Facilities in the vicinity of the location identified above ("Location").
- **nbn** indicative plan/s are attached with this notice ("Indicative Plans").
- The Indicative Plan/s show general depth and alignment information only and are not an exact, scale or accurate depiction of the location, depth and alignment of **nbn™** Facilities shown on the Plan/s.
- In particular, the fact that the Indicative Plans show that a facility is installed in a straight line, or at uniform depth along its length cannot be relied upon as evidence that the facility is, in fact, installed in a straight line or at uniform depth.
- You should read the Indicative Plans in conjunction with this notice and in particular, the notes below.
- You should note that, at the present time, the Indicative Plans are likely to be more accurate in showing location of fibre optics and telecommunications cables than power cables. There may be a variation between the line depicted on the Indicative Plans and the location of any power cables. As such, consistent with the notes below, particular care must be taken by you to make your own enquiries and investigations to precisely locate any power cables and manage the risk arising from such cables accordingly.
- The information contained in the Indicative Plan/s is valid for 28 days from the date of issue set out above. You are expected to make your own inquiries and perform your own investigations (including engaging appropriately qualified plant locators, e.g DBYD Certified Locators, at your cost to locate **nbn™**

ADVERTISED PLAN

This copied document to be made available for the sole purpose of enabling its consideration and review as part of a planning process under the Planning and Environment Act 1987. The document must not be used for any purpose which may breach any copyright

Facilities during any activities you carry out on site).

We thank you for your enquiry and appreciate your continued use of the Dial Before You Dig Service. For any enquiries related to moving assets or Planning and Design activities, please visit the [nbn Commercial Works](#) website to complete the online application form. If you are planning to excavate and require further information, please email dbyd@nbnco.com.au or call 1800 626 329.

Notes:

1. You are now aware that there are **nbn**TM Facilities in the vicinity of the above property that could be damaged as a result activities carried out (or proposed to be carried out) by you in the vicinity of the Location.
2. You should have regard to section 474.6 and 474.7 of the *Criminal Code Act 1995* (CoA) which deals with the consequences of interfering or tampering with a telecommunications facility. Only persons authorised by **nbn** can interact with **nbn**'s network facilities.
3. Any information provided is valid only for **28 days** from the date of issue set out above.

Referral Conditions

The following are conditions on which **nbn** provides you with the Indicative Plans. By accepting the plans, you are agreeing to these conditions. These conditions are in addition, and not in replacement of, any duties and obligations you have under applicable law.

1. **nbn** does not accept any responsibility for any inaccuracies of its plans including the Indicative Plans. You are expected to make your own inquiries and perform your own investigations (including engaging appropriately qualified plant locators, e.g DBYD Certified Locators, at your cost to locate **nbn**TM Facilities during any activities you carry out on site).
2. You acknowledge that **nbn** has specifically notified you above that the Indicative Plans are likely to be more accurate in showing location of fibre optics and telecommunications cables than power cables. There may be a variation between the line depicted on the Indicative Plans and the location of any power cables.
3. You should not assume that **nbn**TM Facilities follow straight lines or are installed at uniformed depths along their lengths, even if they are indicated on plans provided to you. Careful onsite investigations are essential to locate the exact position of cables.
4. In carrying out any works in the vicinity of **nbn**TM Facilities, you must maintain the following minimum clearances:
 - 300mm when laying assets inline, horizontally or vertically.
 - 500mm when operating vibrating equipment, for example: jackhammers or vibrating plates.
 - 1000mm when operating mechanical excavators.
 - Adherence to clearances as directed by other asset owner's instructions and take into account any uncertainty for power cables.
5. You are aware that there are inherent risks and dangers associated with carrying out work in the vicinity of underground facilities (such as **nbn**TM fibre optic, copper and coaxial cables, and power cable feed to **nbn**TM assets). Damage to underground electric cables may result in:
 - Injury from electric shock or severe burns, with the possibility of death.
 - Interruption of the electricity supply to wide areas of the city.
 - Damage to your excavating plant.
 - Responsibility for the cost of repairs.
6. You must take all reasonable precautions to avoid damaging **nbn**TM Facilities. These precautions may include but not limited to the following:
 - All excavation sites should be examined for underground cables by careful hand excavation. Cable cover slabs if present must not be disturbed. Hand excavation needs to be undertaken with extreme care to minimise the likelihood of damage to the cable, for example: the blades of hand equipment should be aligned parallel to the line of the cable rather than digging across the cable.
 - If any undisclosed underground cables are located, notify **nbn** immediately.

Response Cover Letter



Goulburn Valley Water
PO Box 185
SHEPPARTON VIC 3632
www.gvwater.vic.gov.au

Date: 13 November 2023

To:
Glenn McDonald
GHD
Level 9 180 Lonsdale Street
Melbourne 3000

**ADVERTISED
PLAN**

Caution!

High Risk Assets found

According to our records your enquiry with the following details impacts our infrastructure. Please review other documents included with this response for additional details.

Sequence No: 232072252
Job No: 35460873
Location: 765 Dhurringile Road
Toolamba West 3614

This copied document to be made available for the sole purpose of enabling its consideration and review as part of a planning process under the Planning and Environment Act 1987. The document must not be used for any purpose which may breach any copyright

If you require further information, please contact Goulburn Valley Water on 1800 454 500 or control@gvwater.vic.gov.au

Important Notice: This enquiry response, including any associated documentation, has been assessed and compiled from the information detailed within the DBYD enquiry outlined above. Please ensure that the DBYD enquiry details and this response accurately reflect your proposed works.

This response is intended for use only by the addressee. If you have received the enquiry response in error, please let us know by telephone and delete all copies; you are advised that copying, distributing, disclosing or otherwise acting in reliance on the response is expressly prohibited.



The Essential First Step.

While reasonable measures have been taken to ensure the accuracy of the information contained in this plan response, neither Goulburn Valley Water or SmarterWX shall have any liability whatsoever in relation to any loss, damage, cost or expense arising from the use of this plan response or the information contained in it or the completeness or accuracy of such information. Use of such information is subject to and constitutes acceptance of these terms.

ADVERTISED PLAN

- All personnel must be properly briefed, particularly those associated with the use of earth-moving equipment, trenching, boring and pneumatic equipment.
 - The safety of the public and other workers must be ensured.
 - All excavations must be undertaken in accordance with all relevant legislation and regulations.
7. You will be responsible for all damage to **nbn**TM Facilities that are connected whether directly, or indirectly with work you carry out (or work that is carried out for you or on your behalf) at the Location. This will include, without limitation, all losses expenses incurred by **nbn** as a result of any such damage.
 8. You must immediately report any damage to the **nbn**TM network that you are/become aware of. Notification may be by telephone - 1800 626 329.
 9. Except to the extent that liability may not be capable of lawful exclusion, **nbn** and its servants and agents and the related bodies corporate of **nbn** and their servants and agents shall be under no liability whatsoever to any person for any loss or damage (including indirect or consequential loss or damage) however caused (including, without limitation, breach of contract negligence and/or breach of statute) which may be suffered or incurred from or in connection with this information sheet or any plans(including Indicative Plans) attached hereto. Except as expressly provided to the contrary in this information sheet or the attached plans(including Indicative Plans), all terms, conditions, warranties, undertakings or representations (whether expressed or implied) are excluded to the fullest extent permitted by law.

All works undertaken shall be in accordance with all relevant legislations, acts and regulations applicable to the particular state or territory of the Location. The following table lists all relevant documents that shall be considered and adhered to.

State/Territory	Documents
National	Work Health and Safety Act 2011
	Work Health and Safety Regulations 2011
	Safe Work Australia - Working in the Vicinity of Overhead and Underground Electric Lines (Draft)
	Occupational Health and Safety Act 1991
NSW	Electricity Supply Act 1995
	Work Cover NSW - Work Near Underground Assets Guide
	Work Cover NSW - Excavation Work: Code of Practice
VIC	Electricity Safety Act 1998
	Electricity Safety (Network Asset) Regulations 1999
QLD	Electrical Safety Act 2002
	Code of Practice for Working Near Exposed Live Parts
SA	Electricity Act 1996
TAS	Tasmanian Electricity Supply Industry Act 1995
WA	Electricity Act 1945
	Electricity Regulations 1947
NT	Electricity Reform Act 2005
	Electricity Reform (Safety and Technical) Regulations 2005
ACT	Electricity Act 1971

Thank You,

nbn DBYD

Date: 13/11/2023

This copied document to be made available for the sole purpose of enabling its consideration and review as part of a planning process under the Planning and Environment Act 1987. The document must not be used for any purpose which may breach any copyright

This document is provided for information purposes only. This document is subject to the information classification set out on this page. If no information classification has been included, this document must be treated as UNCLASSIFIED, SENSITIVE and must not be disclosed other than with the consent of nbn co. The recipient (including third parties) must make and rely on their own inquiries as to the currency, accuracy and completeness of the information contained herein and must not use this document other than with the consent of nbn co.

Copyright © 2021 nbn co Limited. All rights reserved.

ADVERTISED PLAN

**This copied document to be made available
for the sole purpose of enabling
its consideration and review as
part of a planning process under the
Planning and Environment Act 1987.
The document must not be used for any
purpose which may breach any
copyright**



Sequence No 232072252
Job No 35460873

Authority Details			
To:	Glenn McDonald	Enquiry Date:	13 November 2023
Authority ID:		Enquiry Medium:	
Authority Name:	Private		

Customer Details			
Customer ID:	3475497	Phone:	+61401826531
Contact:	Glenn McDonald	Mobile:	-
Company:	GHD	Fax:	-
Email:	glenn.mcdonald@ghd.com		
Address:	Level 9 180 Lonsdale Street Melbourne 3000		

This copied document to be made available for the sole purpose of enabling its consideration and review as part of a planning process under the Planning and Environment Act 1987. The document must not be used for any purpose which may breach any copyright

Proposed Site Location			
User Reference:	3475497		
Working on Behalf of:	Private		
Start Date:	27 November 2023	End Date:	1 July 2024
Address:	765 Dhurringile Road Toolamba West 3000		
For Planning:		Plans Requested:	
Asset Locate:		Preferred Locate Date:	
Workplace Location:		Location in Road:	
Nature of Works:	Planning & Design		
Additional Work Site Notes:			

ADVERTISED PLAN



While reasonable measures have been taken to ensure the accuracy of the information contained in this plan response, neither Goulburn Valley Water or PelicanCorp shall have any liability whatsoever in relation to any loss, damage, cost or expense arising from the use of this plan response or the information contained in it or the completeness or accuracy of such information. Use of such information is subject to and constitutes acceptance of these terms.

Sequence No 232072252
Job No 35460873



ADVERTISED PLAN

**This copied document to be made available
for the sole purpose of enabling
its consideration and review as
part of a planning process under the
Planning and Environment Act 1987.
The document must not be used for any
purpose which may breach any
copyright**



While reasonable measures have been taken to ensure the accuracy of the information contained in this plan response, neither Goulburn Valley Water or PelicanCorp shall have any liability whatsoever in relation to any loss, damage, cost or expense arising from the use of this plan response or the information contained in it or the completeness or accuracy of such information. Use of such information is subject to and constitutes acceptance of these terms.



ADVERTISED PLAN

-RE
6HT
3URYLGHG E\ *RXOEXUQ 9DOOH\ :DWHU

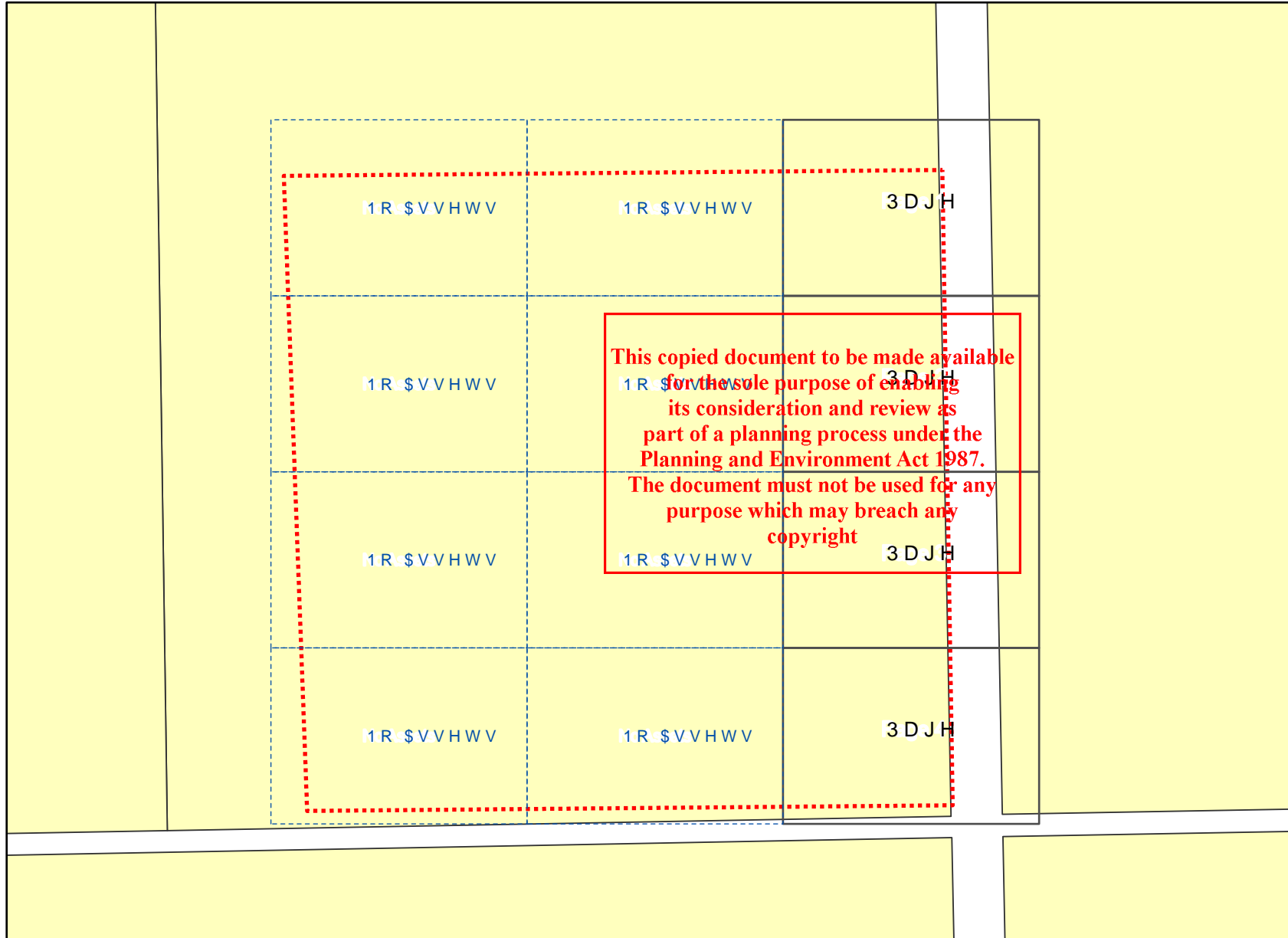

/HJHQQ

▤ % < '\$ (QTXLU)

▭ 'HWDLOHG PDS SDJ

▨ 1R GLJ VLWH DMVH

'6&/\$,0(5 :KLOH UHVRQDEOH
KDYH EHHQ WDNHQ WR HQVXUH
WKH LQIRUPDWLRQ FRQWDLQH
UHVSQVH QHLWKHU *RXOEXUQ
6PDUWHU;; VKDOO KDYH DQ
ZKDWRHYHU LQ UHODWLRQ WR
FRVW RU H[SHQVH DULVLQJ IUR
SODQ UHVSQVH RU WKH LQIRUP
LW RU WKH FRPSOHWHQHVV RU
LQIRUPDWLRQ 8VH RI VXF L
VXEMHFW WR DQG FRQVWLWXW
WKHVH WHUPV

,Q DQ HPHUJHQF\ FRQWDFW *RXOEXUQ 9DOOH\ :DWHU RQ
 ,QGH[6KHHW
 3ODQV JHQHUDWHG E\ 6PDUWHU;;@ \$XWRPDWH

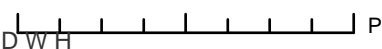

p

6FDOH



ADVERTISED PLAN

-RE
6HT
3URYLGHG E\ *RXOEXUQ 9DOOH\ :DWHU

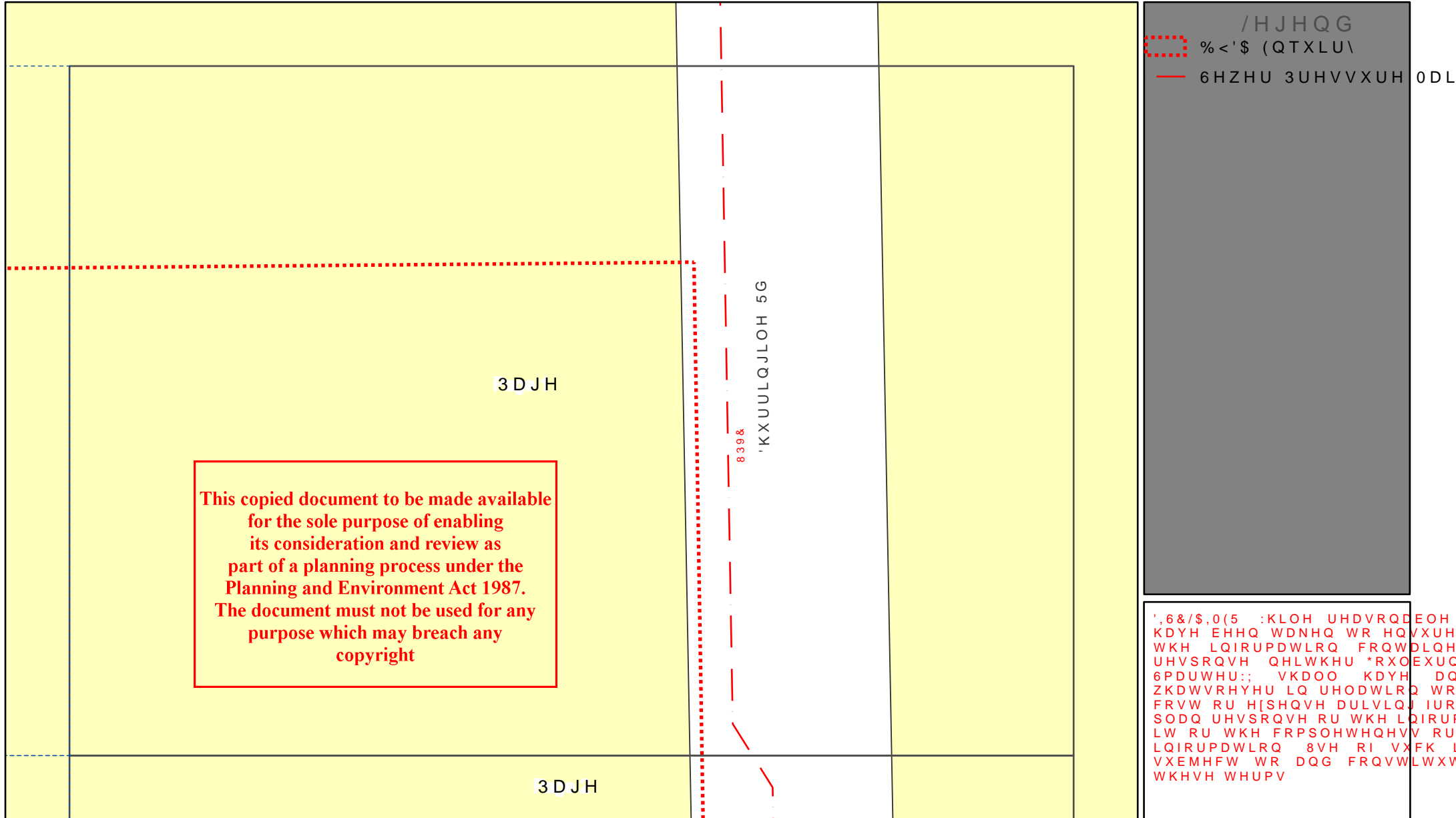

,Q DQ HPHUJHQF\ FRQWDFW *RXOEXUQ 9DOOH\ :DWHU RQ

YDOLG IRU GD\ V

3ODQV JHQHUDWHG E\ 6PDUWUHU::@ \$XWRPDWH



p

6FDOH

/HJHQG
%<'\$(QTXLU\
6HZHU 3UHVXUH 0DL

6&/\$,0(5 :KLOH UHVRQDEOH
KDYH EHHQ WDNHQ WR HQVXUH
WKH LQIRUPDWLRQ FRQWDLQH
UHVSQVH QHLWKHU *RXOEXUQ
6PDUWUHU; VKDOO KDYH DQ
ZKDWRHYHU LQ UHODWLRQ WR
FRVW RU H[SHQVH DULVLQJ IUR
SODQ UHVSQVH RU WKH LQIRUP
LW RU WKH FRPSOHWHQV RU
LQIRUPDWLRQ 8VH RI VXFK L
VXEMHFW WR DQG FRQVWLWXW
WKHVH WHUPV



ADVERTISED PLAN

-RE
6HT
3URYLGHG E\ *RXOEXUQ 9DOOH\ :DWHU

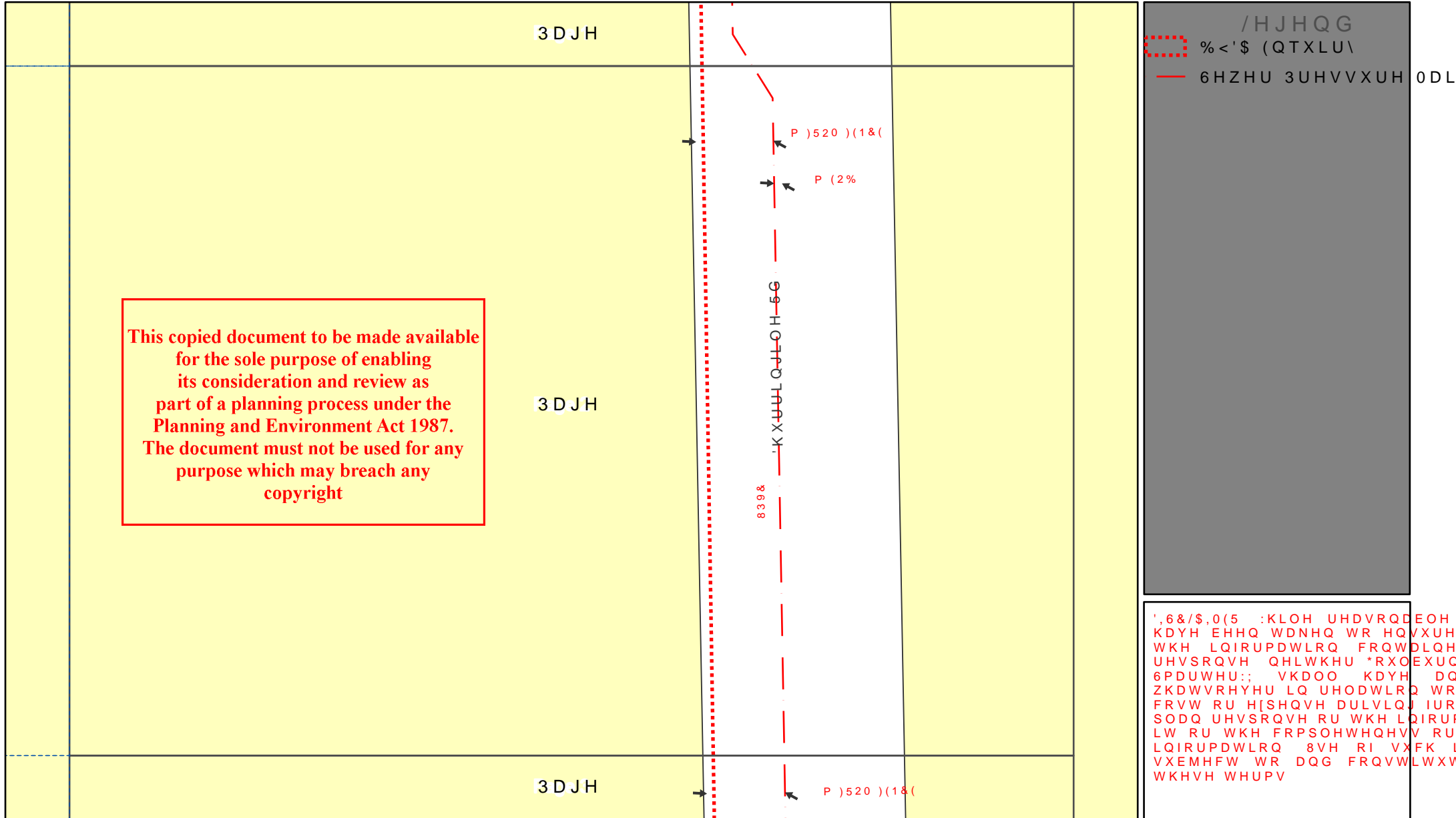

This copied document to be made available for the sole purpose of enabling its consideration and review as part of a planning process under the Planning and Environment Act 1987. The document must not be used for any purpose which may breach any copyright

,Q DQ HPHUJHQF\ FRQWDFW *RXOEXUQ 9DOOH\ :DWHU RQ

YDOLG IRU GD\V

3ODQV JHQHUDWHG E\ 6PDUWHU;;@ \$XWRPDWH

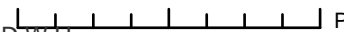

p

6FDOH



ADVERTISED PLAN

-RE
6HT
3URYLGHG E\ *RXOEXUQ 9DOOH\ :DWHU

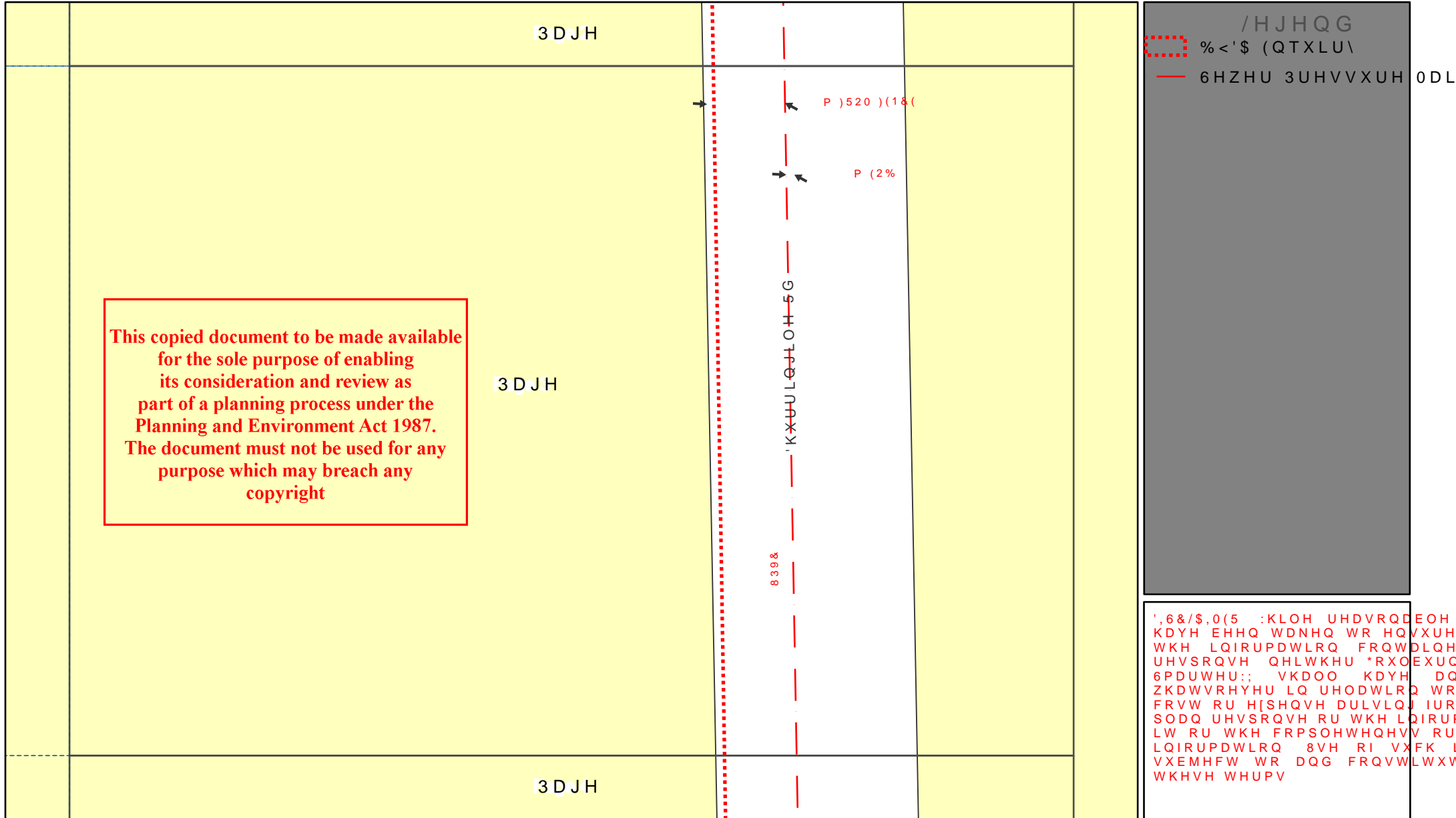

,Q DQ HPHUJHQF\ FRQWDFW *RXOEXUQ 9DOOH\ :DWHU RQ

YDOLG IRU GD\V

3ODQV JHQHUDWHG E\ 6PDUWHU;;@ \$XWRPDWH

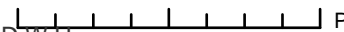

p

6FDOH



ADVERTISED PLAN

-RE
6HT
3URYLGHG E\ *RXOEXUQ 9DOOH\ :DWHU

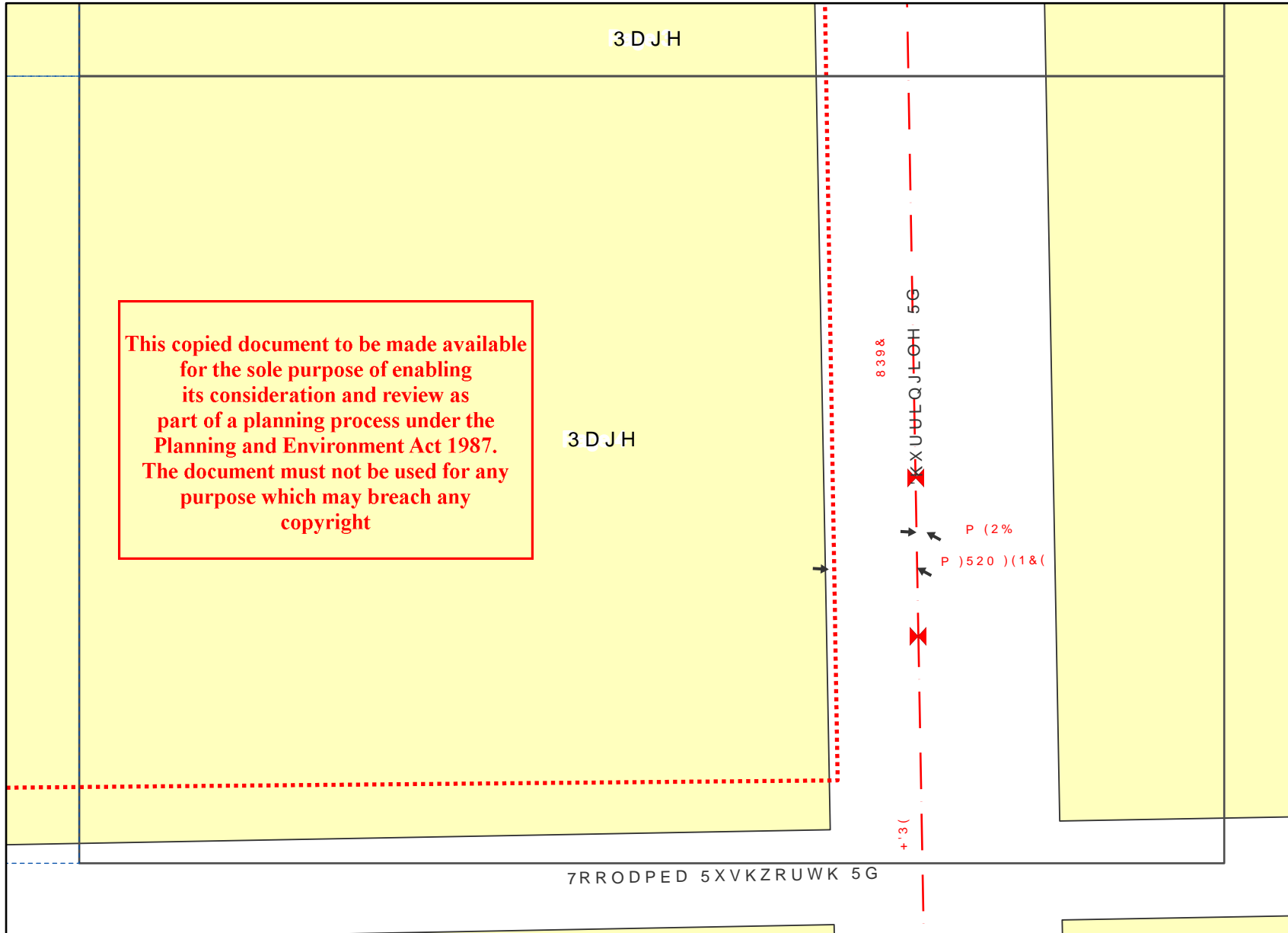

This copied document to be made available for the sole purpose of enabling its consideration and review as part of a planning process under the Planning and Environment Act 1987. The document must not be used for any purpose which may breach any copyright

/HJHQG
%<'\$(QTXLU\
— 6HZHU 3UHVXUH 0DL
✕ 6HZHU 9DOYHV

839&
XUJLQH 5G
P (2% P)520)(1&
+3(

7RRODPED 5XVKZRUK 5G

6&/\$,0(5 :KLOH UHVRQDEOH
KDYH EHHQ WDNHQ WR HQVXUH
WKH LQIRUPDWLRQ FRQWDLQH
UHVSQVH QHLWKHU *RXOEXUQ
6PDUWHU;; VKDOO KDYH DQ
ZKDWVRHYHU LQ UHODWLRQ WR
FRVW RU H[SHQVH DULVLQJ IUR
SODQ UHVSQVH RU WKH LQIRUP
LW RU WKH FRPSOHWHQHVV RU
LQIRUPDWLRQ 8VH RI VXFK L
VXEMHFW WR DQG FRQVWLWXW
WKHVH WHUPV

,Q DQ HPHUJHQF\ FRQWDFW *RXOEXUQ 9DOOH\ :DWHU RQ
YDOLG IRU GD\ V
3ODQV JHQHUDWHG E\ 6PDUWHU;;@ \$XWRPDWH

p 6FDOH



APA Group
PO Box 6014 Halifax
Street,
South Australia 5000

ADVERTISED PLAN

13/11/2023

Company: GHD
Glenn McDonald
Level 9, 180 Lonsdale Street
Melbourne
VIC 3000

glenn.mcdonald@ghd.com

Dear Glenn McDonald

Sequence Number: 232072251
Worksite Address: 765 Dhurringile Road
Toolamba West
VIC 3614

This copied document to be made available for the sole purpose of enabling its consideration and review as part of a planning process under the Planning and Environment Act 1987. The document must not be used for any purpose which may breach any copyright

Thank you for your Before You Dig enquiry regarding the location of APA Group (APA) operated Gas Assets.

We confirm there are **NO** Gas Assets in the vicinity of the above location.

Caution - Damage to gas assets may result in explosion, fire and personal injury.

You are hereby notified the Duty of Care requirements described below apply to any activity in the vicinity of APA operated Gas Assets. Please ensure you read and comply with all the relevant requirements where applicable.

Contacts – APA Group	
Enquiry Type	Contact Numbers
General enquiries or feedback regarding this information or gas assets. <div style="text-align: right;"> QLD Only All other States </div>	APA - Before You Dig Officer Phone: 1800 085 628 Email: PermitsQld@apa.com.au Phone: 1800 085 628 Email: DBYDNetworksAPA@apa.com.au
Gas Emergencies	Phone: 1800 GAS LEAK (1800 427 532)

Please find below the following information:

- Duty of Care** - If you are unclear of your obligations under these requirements please contact the Before You Dig officer for clarification.
- An overview map** highlighting the area of your intended works.
- Map(s) showing APA operated Gas Assets** within the area of your intended works.

Important Information:

- This information is valid for 30 days from the date of this response.
- This information shall be available on site whilst conducting works.
- This information has been generated by an automated system based on the area highlighted in your BYDA request and has not been independently verified. Please check the maps represent the area you requested. If they do not, please contact the APA - Before You Dig officer.
- For some BYDA enquiries, you may receive two (2) responses from APA. Please read both responses carefully as they relate to different assets.

Yours Faithfully,

APA Group

ADVERTISED PLAN

**This copied document to be made available
for the sole purpose of enabling
its consideration and review as
part of a planning process under the
Planning and Environment Act 1987.
The document must not be used for any
purpose which may breach any
copyright**

Duty of Care - Working Around Gas Assets

General Conditions

- BYDA enquiries are valid for 30 days. If your works commence after 30 days from the date of this response a new enquiry is required to validate location information.
- The location information supplied in this document shall be used as a guide only. APA does not guarantee the accuracy or completeness of the map and does not make any warranty about the data. APA is not under any liability to the user for any loss or damage (including consequential loss or damage) which the user may suffer resulting from the use of this information or maps.
- It is the responsibility of the excavator to expose all Gas Assets by hand digging. Gas Asset depths may vary according to ground conditions.
- Gas (inlet) Services connecting Gas Assets in the street to the gas meter on the property are not marked on the map. South Australia Only - If a meter box is installed on the property, a sketch of the gas service location may be found inside the gas meter box. APA does not guarantee the accuracy or completeness of these sketches.
- Road authorities, council's, and their authorised contractors and agents are responsible to pot-hole or use other suitable methods to verify the location and depth of all gas assets, including Gas (inlet) Services, prior to commencing any works.
- The location and depth of underground mains & services, including those in the road corridor and footpath, may vary in alignment and depth of cover, as a result of changes to road, footpath or surface levels subsequent to installation.
- Some Gas Assets may be installed inside a casing. Locations where a Gas Asset changes from being located within, to being located outside a casing may not be marked on the maps provided.
- The use of hydro-vacuum excavation in vicinity to Gas Assets is permitted under the following conditions:
 - Maximum water pressure of 1000psi unless otherwise advised.
 - A minimum distance of 100mm shall be maintained between the end of the pressure wand nozzle and gas assets.
 - Vertical movements of the pressure wand nozzle or inserting the nozzle in vicinity of the gas asset prohibited
 - The use of root cutting heads is prohibited.

Where a gas asset has been exposed via hydro-vacuum excavation a visual check must be undertaken to ensure no damage has occurred to the pipe or it's coating. If any damage has occurred notify the APA Before You Dig Officer.

**ADVERTISED
PLAN**

This copied document to be made available for the sole purpose of enabling its consideration and review as part of a planning process under the Planning and Environment Act 1987. The document must not be used for any purpose which may breach any copyright

Site Watch / Locate Service

Site Watch - A condition of an APA Authority To Work permit is for an APA Site Watch representative be present on site whilst conducting works. The purpose is to monitor works and protect gas assets in the vicinity from potential damage by the works.

Locate – This service is available on request, where an APA representative will visit your work site before work commencement to electronically locate and mark on the ground surface all gas assets in vicinity of the work site.

These services are provided under the following conditions:

- Contact APA - Before You Dig officer to make a booking. Contact details in the table above.
- The following rates are chargeable for these services:

Item	Rate (excl. gst)
Site Watch – Normal Business Hours	\$143.42 per hour
Site Watch - After Hours	\$175.06 per hour
Electronic Locate – Normal Business Hours	\$143.42 per hour
Electronic Locate – After Hours	\$175.06 per hour
Cancellation Fee	2 hrs Normal Business Hours rate (where cancellations received <u>after</u> 12pm (midday) one (1) business day prior to the booking)
Mains Proving	Quoted on request

Notes:

- 1hr minimum charge applies.
- A Cancellation Fee applies where cancellations are received after 12pm (midday) one(1) business day prior to the booked Site Watch / Locate service
- Contact APA - Before You Dig officer for state specific hours of business.



**ADVERTISED
PLAN**

This copied document to be made available for the sole purpose of enabling its consideration and review as part of a planning process under the Planning and Environment Act 1987. The document must not be used for any purpose which may breach any copyright

ADVERTISED PLAN

Site Address	765 Dhurringile Road Toolamba West 3614	Sequence No	232072251
Name	Glenn McDonald		
Email	glenn.mcdonald@ghd.com		



Scale 1: 6000		Enquiry Area  Map Key Area 
---------------	---	---

90 Welsford Street
Shepparton
Victoria, 3630

To:
Glenn McDonald
180 Lonsdale Street Level 9
Melbourne VIC 3000

This copied document to be made available for the sole purpose of enabling its consideration and review as part of a planning process under the Planning and Environment Act 1987. The document must not be used for any purpose which may breach any copyright

Enquiry Details	
Utility ID	22830
Job Number	35460873
Sequence Number	232072253
Enquiry Date	13/11/2023 15:01
Response	NOT AFFECTED
Address	765 Dhurringile Road Toolamba West
Location in Road	
Activity	Planning and Design

Enquirer Details	
Customer ID	3475497
Contact	Glenn McDonald
Company	
Email	glenn.mcdonald@ghd.com
Phone	+61401826531 e

**ADVERTISED
PLAN**

Attached is a map of Greater Shepparton City Council assets in the area of your enquiry. This does not include private assets.

Please note these plans are indicative locations only and are to be used in conjunction with onsite visual identification of assets.

Any works within the road reserve including the road, footpath or nature strip requires consent from the council. Please contact the Permit Inspection Officer at the council using the contact details below.

If you require further information please contact the Works Maintenance Department on (03) 5832 9828 or DBYD@shepparton.vic.gov.au.

Damaged Infrastructure: Any damage to Greater Shepparton City Council's infrastructure should be reported immediately to Customer Service on phone: (03) 5832 9700. Any damage found at a later date, or upon completion of works not reported to Council, will be repaired at the direct cost of the applicant.

While reasonable measures have been taken to ensure the accuracy of the information contained in this plan response, neither Greater Shepparton City Council or Mipela GeoSolutions shall have any liability whatsoever in relation to any loss, damage, cost or expense arising from the use of this plan response or the information contained in it or the completeness or accuracy of such information. Use of such information is subject to and constitutes acceptance of these terms.

**ADVERTISED
PLAN**

This copied document to be made available for the sole purpose of enabling its consideration and review as part of a planning process under the Planning and Environment Act 1987. The document must not be used for any purpose which may breach any copyright

Greater Shepparton City Council
Locked Bag 1000, Shepparton, Vic, 3632
Council Office: 90 Welsford Street, Shepparton
Ph: (03) 5832 9700 Email: council@shepparton.vic.gov.au
www.greatershepparton.com.au
ABN 59 835 329 843

Overview Map

Sequence No: 232072253

765 Dhurringile Road Toolamba West

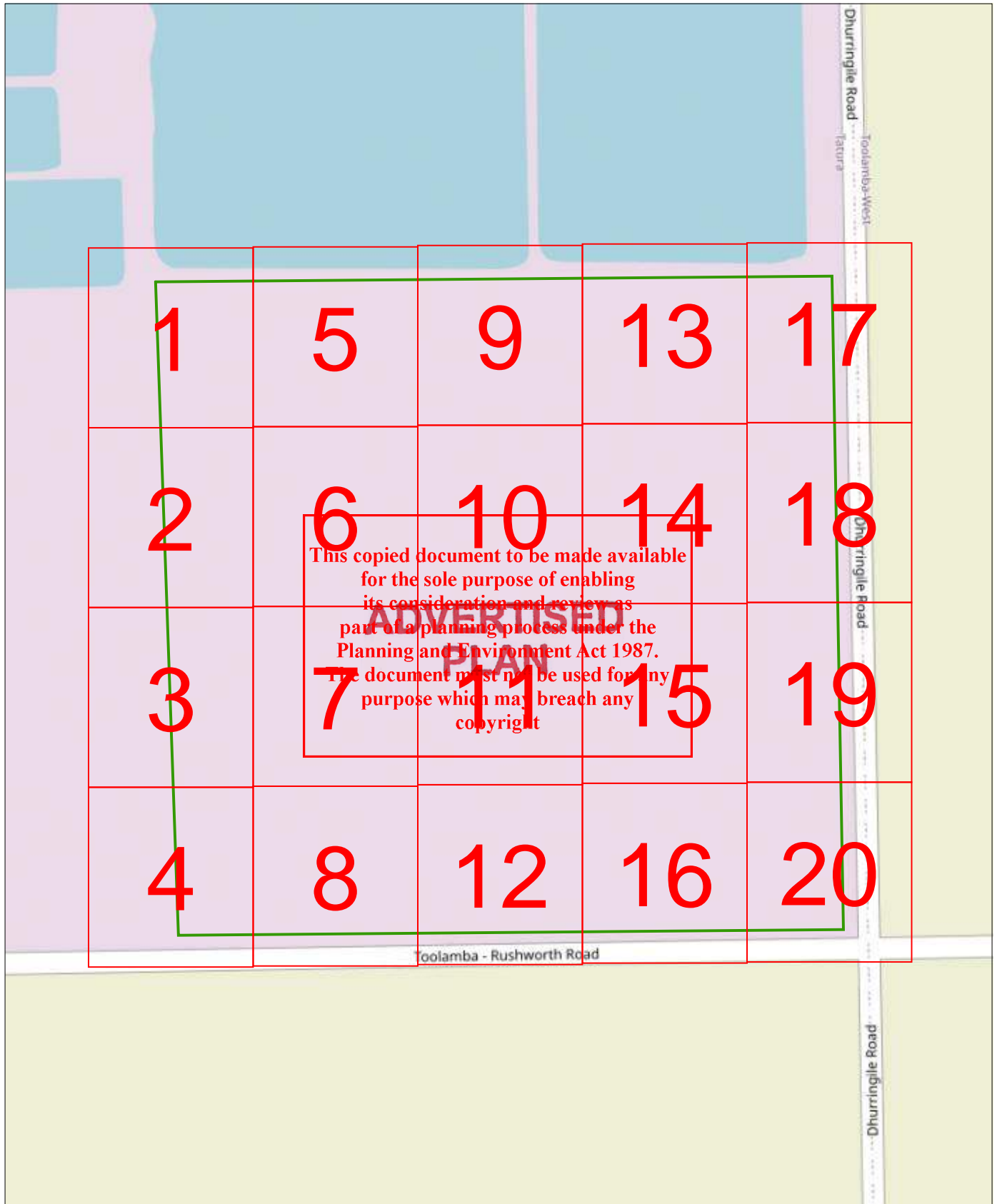

DISCLAIMER: Greater Shepparton City Council does not warrant that this map is definitive nor free of error and does not accept liability for any loss caused or arising from reliance upon information provided herein.
 The location of Council owned assets shown on this map report is approximate only and the exact position of any of these assets should be confirmed on site.



LEGEND:

- 1 Detail Map
- Not Affected BYDA Work Area

1











This copied document to be made available for the sole purpose of enabling its consideration and review as part of a planning process under the Planning and Environment Act 1987. The document must not be used for any purpose which may breach any copyright

ADVERTISED PLAN

DISCLAIMER: Greater Shepparton City Council does not warrant that this map is definitive nor free of error and does not accept liability for any loss caused or arising from reliance upon information provided herein.

The location of Council owned assets shown on this map report is approximate only and the exact position of any of these assets should be confirmed on site.

LEGEND:

-  Not Affected BYDA Work Area
-  Fire Plugs
-  Sewerage Pit
-  Sewerage Pipe
-  Stormwater Pit
-  Stormwater Pipe
-  Underground Electrical Line
-  Raw Water Main
-  Kerb
-  Footpath
-  Property

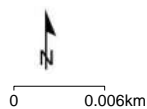



Map 2

Sequence No: 232072253
765 Dhurringile Road Toolamba West

2











This copied document to be made available for the sole purpose of enabling its consideration and review as part of a planning process under the Planning and Environment Act 1987. The document must not be used for any purpose which may breach any copyright

ADVERTISED PLAN

DISCLAIMER: Greater Shepparton City Council does not warrant that this map is definitive nor free of error and does not accept liability for any loss caused or arising from reliance upon information provided herein.

The location of Council owned assets shown on this map report is approximate only and the exact position of any of these assets should be confirmed on site.

LEGEND:

-  Not Affected BYDA Work Area
-  Fire Plugs
-  Sewerage Pit
-  Sewerage Pipe
-  Stormwater Pit
-  Stormwater Pipe
-  Underground Electrical Line
-  Raw Water Main
-  Kerb
-  Footpath
-  Property

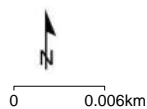



Map 3

Sequence No: 232072253
765 Dhurringile Road Toolamba West

3











This copied document to be made available for the sole purpose of enabling its consideration and review as part of a planning process under the Planning and Environment Act 1987. The document must not be used for any purpose which may breach any copyright

ADVERTISED PLAN

DISCLAIMER: Greater Shepparton City Council does not warrant that this map is definitive nor free of error and does not accept liability for any loss caused or arising from reliance upon information provided herein.

The location of Council owned assets shown on this map report is approximate only and the exact position of any of these assets should be confirmed on site.

LEGEND:

-  Not Affected BYDA Work Area
-  Fire Plugs
-  Sewerage Pit
-  Sewerage Pipe
-  Stormwater Pit
-  Stormwater Pipe
-  Underground Electrical Line
-  Raw Water Main
-  Kerb
-  Footpath
-  Property

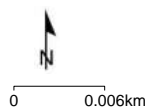



Map 4

Sequence No: 232072253

765 Dhurringile Road Toolamba West

4

**ADVERTISED
PLAN**

This copied document to be made available for the sole purpose of enabling its consideration and review as part of a planning process under the Planning and Environment Act 1987. The document must not be used for any purpose which may breach any copyright

Toolamba - Rushworth Road

DISCLAIMER: Greater Shepparton City Council does not warrant that this map is definitive nor free of error and does not accept liability for any loss caused or arising from reliance upon information provided herein.

The location of Council owned assets shown on this map report is approximate only and the exact position of any of these assets should be confirmed on site.

LEGEND:

- Not Affected BYDA Work Area
- ▲ Fire Plugs
- Sewerage Pit
- Sewerage Pipe
- Stormwater Pit
- Stormwater Pipe
- Underground Electrical Line
- Raw Water Main
- Kerb
- Footpath
- Property

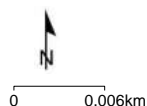

5











This copied document to be made available for the sole purpose of enabling its consideration and review as part of a planning process under the Planning and Environment Act 1987. The document must not be used for any purpose which may breach any copyright

ADVERTISED PLAN

DISCLAIMER: Greater Shepparton City Council does not warrant that this map is definitive nor free of error and does not accept liability for any loss caused or arising from reliance upon information provided herein.

The location of Council owned assets shown on this map report is approximate only and the exact position of any of these assets should be confirmed on site.

LEGEND:

	Not Affected BYDA Work Area		Raw Water Main
	Fire Plugs		Kerb
	Sewerage Pit		Footpath
	Sewerage Pipe		Property
	Stormwater Pit		
	Stormwater Pipe		
	Underground Electrical Line		

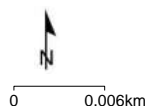

6











**This copied document to be made available
for the sole purpose of enabling
its consideration and review as
part of a planning process under the
Planning and Environment Act 1987.
The document must not be used for any
purpose which may breach any
copyright**

ADVERTISED PLAN

DISCLAIMER: Greater Shepparton City Council does not warrant that this map is definitive nor free of error and does not accept liability for any loss caused or arising from reliance upon information provided herein.

The location of Council owned assets shown on this map report is approximate only and the exact position of any of these assets should be confirmed on site.

LEGEND:

	Not Affected BYDA Work Area		Raw Water Main
	Fire Plugs		Kerb
	Sewerage Pit		Footpath
	Sewerage Pipe		Property
	Stormwater Pit		
	Stormwater Pipe		
	Underground Electrical Line		

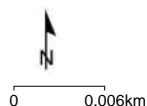

7











This copied document to be made available for the sole purpose of enabling its consideration and review as part of a planning process under the Planning and Environment Act 1987. The document must not be used for any purpose which may breach any copyright

ADVERTISED PLAN

DISCLAIMER: Greater Shepparton City Council does not warrant that this map is definitive nor free of error and does not accept liability for any loss caused or arising from reliance upon information provided herein.

The location of Council owned assets shown on this map report is approximate only and the exact position of any of these assets should be confirmed on site.

LEGEND:

	Not Affected BYDA Work Area		Raw Water Main
	Fire Plugs		Kerb
	Sewerage Pit		Footpath
	Sewerage Pipe		Property
	Stormwater Pit		
	Stormwater Pipe		
	Underground Electrical Line		

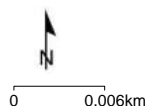

8

**This copied document to be made available
for the sole purpose of enabling
its consideration and review as
part of a planning process under the
Planning and Environment Act 1987.
The document must not be used for any
purpose which may breach any
copyright**











ADVERTISED PLAN

Toolamba - Rushworth Road

DISCLAIMER: Greater Shepparton City Council does not warrant that this map is definitive nor free of error and does not accept liability for any loss caused or arising from reliance upon information provided herein.

The location of Council owned assets shown on this map report is approximate only and the exact position of any of these assets should be confirmed on site.

LEGEND:

	Not Affected BYDA Work Area		Raw Water Main
	Fire Plugs		Kerb
	Sewerage Pit		Footpath
	Sewerage Pipe		Property
	Stormwater Pit		
	Stormwater Pipe		
	Underground Electrical Line		

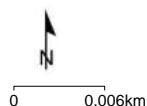

9











This copied document to be made available for the sole purpose of enabling its consideration and review as part of a planning process under the Planning and Environment Act 1987. The document must not be used for any purpose which may breach any copyright

ADVERTISED PLAN

DISCLAIMER: Greater Shepparton City Council does not warrant that this map is definitive nor free of error and does not accept liability for any loss caused or arising from reliance upon information provided herein.

The location of Council owned assets shown on this map report is approximate only and the exact position of any of these assets should be confirmed on site.

LEGEND:

	Not Affected BYDA Work Area		Raw Water Main
	Fire Plugs		Kerb
	Sewerage Pit		Footpath
	Sewerage Pipe		Property
	Stormwater Pit		
	Stormwater Pipe		
	Underground Electrical Line		

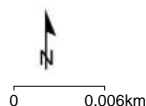

10











This copied document to be made available for the sole purpose of enabling its consideration and review as part of a planning process under the Planning and Environment Act 1987. The document must not be used for any purpose which may breach any copyright

ADVERTISED PLAN

DISCLAIMER: Greater Shepparton City Council does not warrant that this map is definitive nor free of error and does not accept liability for any loss caused or arising from reliance upon information provided herein.

The location of Council owned assets shown on this map report is approximate only and the exact position of any of these assets should be confirmed on site.

LEGEND:

	Not Affected BYDA Work Area		Raw Water Main
	Fire Plugs		Kerb
	Sewerage Pit		Footpath
	Sewerage Pipe		Property
	Stormwater Pit		
	Stormwater Pipe		
	Underground Electrical Line		

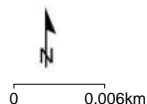

11











This copied document to be made available for the sole purpose of enabling its consideration and review as part of a planning process under the Planning and Environment Act 1987. The document must not be used for any purpose which may breach any copyright

ADVERTISED PLAN

DISCLAIMER: Greater Shepparton City Council does not warrant that this map is definitive nor free of error and does not accept liability for any loss caused or arising from reliance upon information provided herein.

The location of Council owned assets shown on this map report is approximate only and the exact position of any of these assets should be confirmed on site.

LEGEND:

	Not Affected BYDA Work Area		Raw Water Main
	Fire Plugs		Kerb
	Sewerage Pit		Footpath
	Sewerage Pipe		Property
	Stormwater Pit		
	Stormwater Pipe		
	Underground Electrical Line		

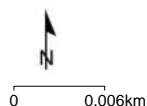

12

This copied document to be made available for the sole purpose of enabling its consideration and review as part of a planning process under the Planning and Environment Act 1987. The document must not be used for any purpose which may breach any copyright











ADVERTISED PLAN

Toolamba - Rushworth Road

DISCLAIMER: Greater Shepparton City Council does not warrant that this map is definitive nor free of error and does not accept liability for any loss caused or arising from reliance upon information provided herein.

The location of Council owned assets shown on this map report is approximate only and the exact position of any of these assets should be confirmed on site.

LEGEND:

	Not Affected BYDA Work Area		Raw Water Main
	Fire Plugs		Kerb
	Sewerage Pit		Footpath
	Sewerage Pipe		Property
	Stormwater Pit		
	Stormwater Pipe		
	Underground Electrical Line		

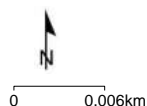

13











This copied document to be made available for the sole purpose of enabling its consideration and review as part of a planning process under the Planning and Environment Act 1987. The document must not be used for any purpose which may breach any copyright

ADVERTISED PLAN

DISCLAIMER: Greater Shepparton City Council does not warrant that this map is definitive nor free of error and does not accept liability for any loss caused or arising from reliance upon information provided herein.

The location of Council owned assets shown on this map report is approximate only and the exact position of any of these assets should be confirmed on site.

LEGEND:

	Not Affected BYDA Work Area		Raw Water Main
	Fire Plugs		Kerb
	Sewerage Pit		Footpath
	Sewerage Pipe		Property
	Stormwater Pit		
	Stormwater Pipe		
	Underground Electrical Line		

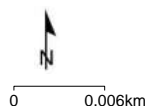

14











This copied document to be made available for the sole purpose of enabling its consideration and review as part of a planning process under the Planning and Environment Act 1987. The document must not be used for any purpose which may breach any copyright

ADVERTISED PLAN

DISCLAIMER: Greater Shepparton City Council does not warrant that this map is definitive nor free of error and does not accept liability for any loss caused or arising from reliance upon information provided herein.

The location of Council owned assets shown on this map report is approximate only and the exact position of any of these assets should be confirmed on site.

LEGEND:

	Not Affected BYDA Work Area		Raw Water Main
	Fire Plugs		Kerb
	Sewerage Pit		Footpath
	Sewerage Pipe		Property
	Stormwater Pit		
	Stormwater Pipe		
	Underground Electrical Line		

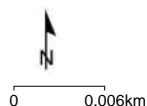

15











This copied document to be made available for the sole purpose of enabling its consideration and review as part of a planning process under the Planning and Environment Act 1987. The document must not be used for any purpose which may breach any copyright

ADVERTISED PLAN

DISCLAIMER: Greater Shepparton City Council does not warrant that this map is definitive nor free of error and does not accept liability for any loss caused or arising from reliance upon information provided herein.

The location of Council owned assets shown on this map report is approximate only and the exact position of any of these assets should be confirmed on site.

LEGEND:

	Not Affected BYDA Work Area		Raw Water Main
	Fire Plugs		Kerb
	Sewerage Pit		Footpath
	Sewerage Pipe		Property
	Stormwater Pit		
	Stormwater Pipe		
	Underground Electrical Line		

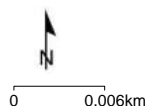

16

This copied document to be made available for the sole purpose of enabling its consideration and review as part of a planning process under the Planning and Environment Act 1987. The document must not be used for any purpose which may breach any copyright











ADVERTISED PLAN

Toolamba - Rushworth Road

DISCLAIMER: Greater Shepparton City Council does not warrant that this map is definitive nor free of error and does not accept liability for any loss caused or arising from reliance upon information provided herein.

The location of Council owned assets shown on this map report is approximate only and the exact position of any of these assets should be confirmed on site.

LEGEND:

	Not Affected BYDA Work Area		Raw Water Main
	Fire Plugs		Kerb
	Sewerage Pit		Footpath
	Sewerage Pipe		Property
	Stormwater Pit		
	Stormwater Pipe		
	Underground Electrical Line		

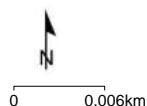



Map 17

Sequence No: 232072253

765 Dhurringile Road Toolamba West

17

ADVERTISED PLAN

This copied document to be made available for the sole purpose of enabling its consideration and review as part of a planning process under the Planning and Environment Act 1987. The document must not be used for any purpose which may breach any copyright

Dhurringile Road











Dhurringile

765

DISCLAIMER: Greater Shepparton City Council does not warrant that this map is definitive nor free of error and does not accept liability for any loss caused or arising from reliance upon information provided herein.

The location of Council owned assets shown on this map report is approximate only and the exact position of any of these assets should be confirmed on site.

LEGEND:

-  Not Affected BYDA Work Area
-  Fire Plugs
-  Sewerage Pit
-  Sewerage Pipe
-  Stormwater Pit
-  Stormwater Pipe
-  Underground Electrical Line
-  Raw Water Main
-  Kerb
-  Footpath
-  Property

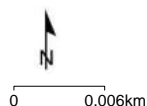



Map 18

Sequence No: 232072253

765 Dhurringile Road Toolamba West

18

ADVERTISED PLAN











Dhurringile Road

This copied document to be made available for the sole purpose of enabling its consideration and review as part of a planning process under the Planning and Environment Act 1987. The document must not be used for any purpose which may breach any copyright

DISCLAIMER: Greater Shepparton City Council does not warrant that this map is definitive nor free of error and does not accept liability for any loss caused or arising from reliance upon information provided herein.

The location of Council owned assets shown on this map report is approximate only and the exact position of any of these assets should be confirmed on site.

LEGEND:

-  Not Affected BYDA Work Area
-  Fire Plugs
-  Sewerage Pit
-  Sewerage Pipe
-  Stormwater Pit
-  Stormwater Pipe
-  Underground Electrical Line
-  Raw Water Main
-  Kerb
-  Footpath
-  Property

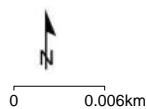

19

ADVERTISED PLAN











Dhurringile Road

This copied document to be made available for the sole purpose of enabling its consideration and review as part of a planning process under the Planning and Environment Act 1987. The document must not be used for any purpose which may breach any copyright

DISCLAIMER: Greater Shepparton City Council does not warrant that this map is definitive nor free of error and does not accept liability for any loss caused or arising from reliance upon information provided herein.

The location of Council owned assets shown on this map report is approximate only and the exact position of any of these assets should be confirmed on site.

LEGEND:

-  Not Affected BYDA Work Area
-  Fire Plugs
-  Sewerage Pit
-  Sewerage Pipe
-  Stormwater Pit
-  Stormwater Pipe
-  Underground Electrical Line
-  Raw Water Main
-  Kerb
-  Footpath
-  Property

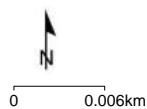

20

ADVERTISED PLAN



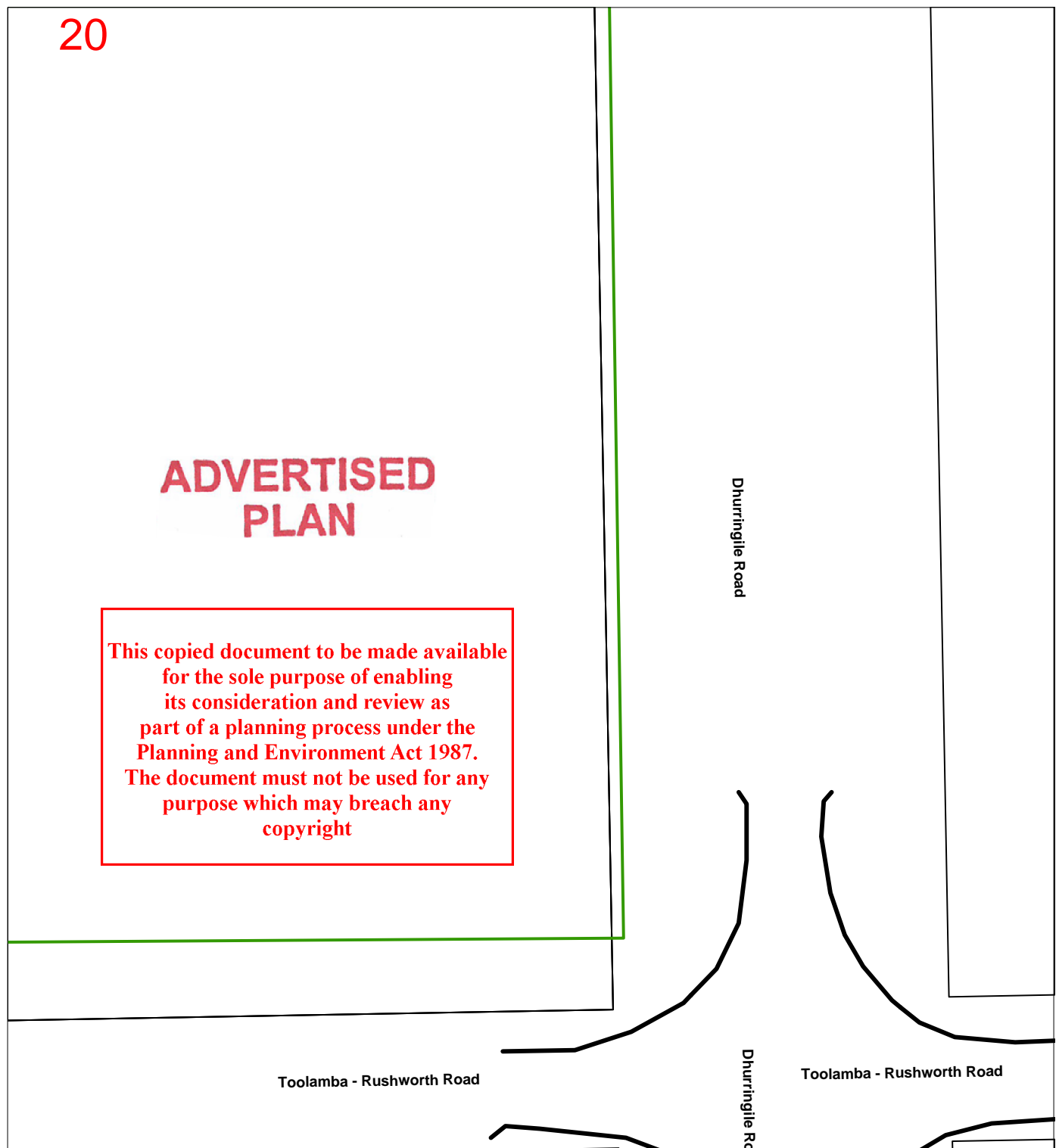







This copied document to be made available for the sole purpose of enabling its consideration and review as part of a planning process under the Planning and Environment Act 1987. The document must not be used for any purpose which may breach any copyright



DISCLAIMER: Greater Shepparton City Council does not warrant that this map is definitive nor free of error and does not accept liability for any loss caused or arising from reliance upon information provided herein.

The location of Council owned assets shown on this map report is approximate only and the exact position of any of these assets should be confirmed on site.

LEGEND:

-  Not Affected BYDA Work Area
-  Fire Plugs
-  Sewerage Pit
-  Sewerage Pipe
-  Stormwater Pit
-  Stormwater Pipe
-  Underground Electrical Line
-  Raw Water Main
-  Kerb
-  Footpath
-  Property

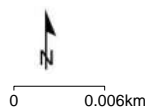



This copied document to be made available
for the sole purpose of enabling
its consideration and review as
part of a planning process under the
Planning and Environment Act 1987.
The document must not be used for any
purpose which may breach any
copyright



This copied document to be made available
for the sole purpose of enabling
its consideration and review as
part of a planning process under the
Planning and Environment Act 1987.
The document must not be used for any
purpose which may breach any
copyright