

This copied document to be made available for the sole purpose of enabling its consideration and review as part of a planning process under the Planning and Environment Act 1987. The document must not be used for any purpose which may breach any copyright

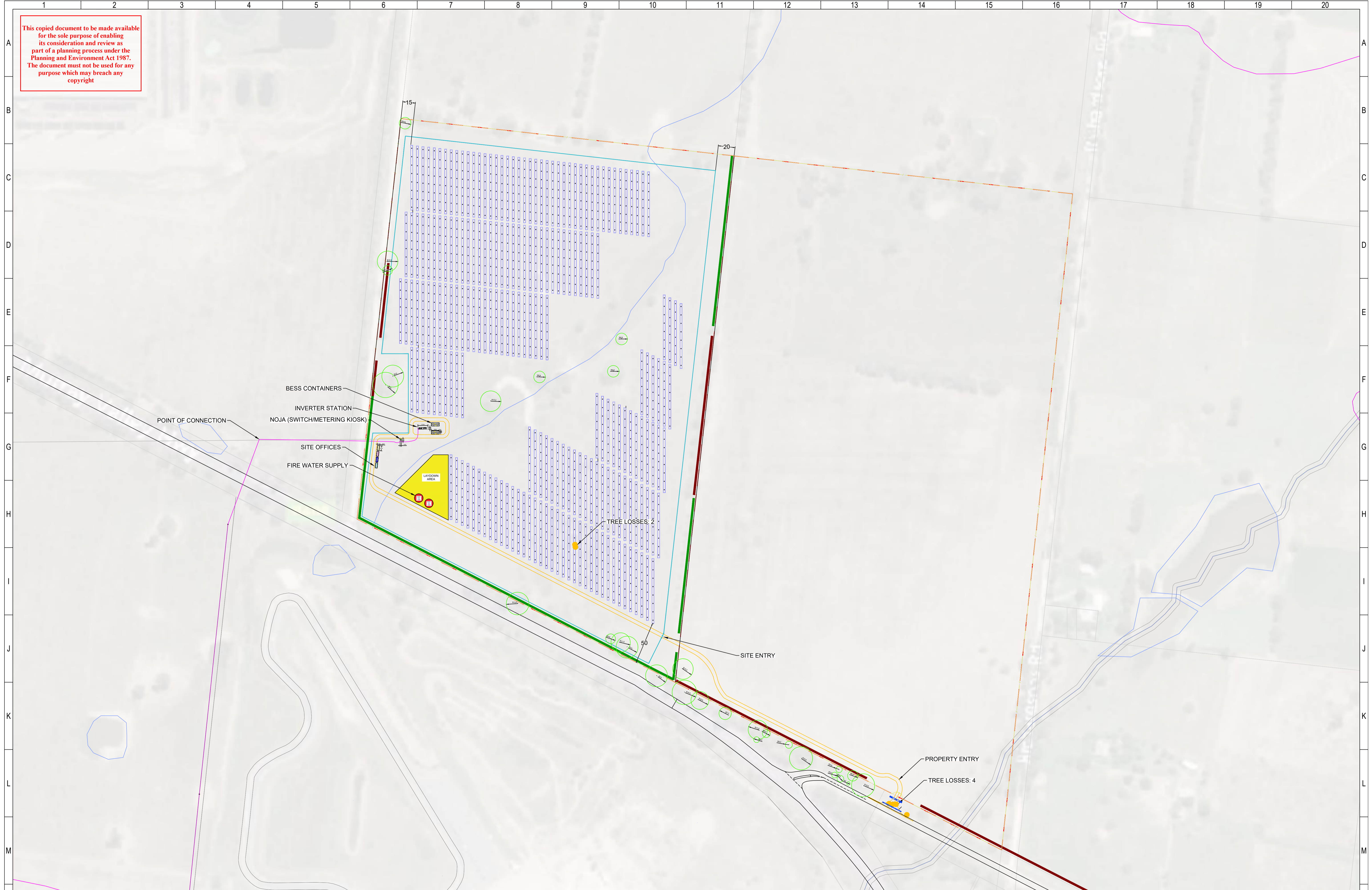

SYSTEM DETAILS	PANELS	INVERTER	LEGEND
SIZE (DC): 8.54 kWp SIZE (AC): 4950 kW DC/AC RATIO: 1.73 PITCH: 6.00 M	MFR: - MODEL: - POWER: 680W QUANTITY: -	MFR: SUNGROW MODEL: SG2475HV POWER: 2475kWAC QUANTITY: 2	<ul style="list-style-type: none"> PV TRACKER UNDERGROUND 22KV CABLE OVERHEAD 22KV CABLE CFA SETBACK (10 METRE) FENCING (EXISTING) SECURITY FENCING SCREEN PLANTING EXISTING SCREEN TREE LOSSES NATIVE VEGETATION TP2

ADVERTISED PLAN

REV	DESCRIPTION	BY	DATE
A	PRELIMINARY DESIGN	DA	21-07-23

DRAWN	CHECKED	VERIFIED	DATE
DA	MD	MD	21-07-23
		BY	DATE

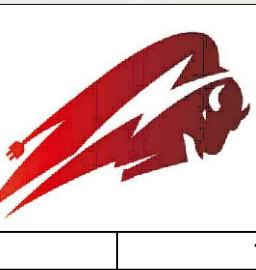

PROJECT: BARNAWARTHA NORTH SOLAR FARM	PAPER SIZE: A1
154 MARGERYS ROAD BARNAWARTHA NORTH VIC 3691	
TITLE: SITE LAYOUT	
SHEET 1	REV: A
JOB No: SPAU011	DWG No: E001
SCALE: 1:2000	

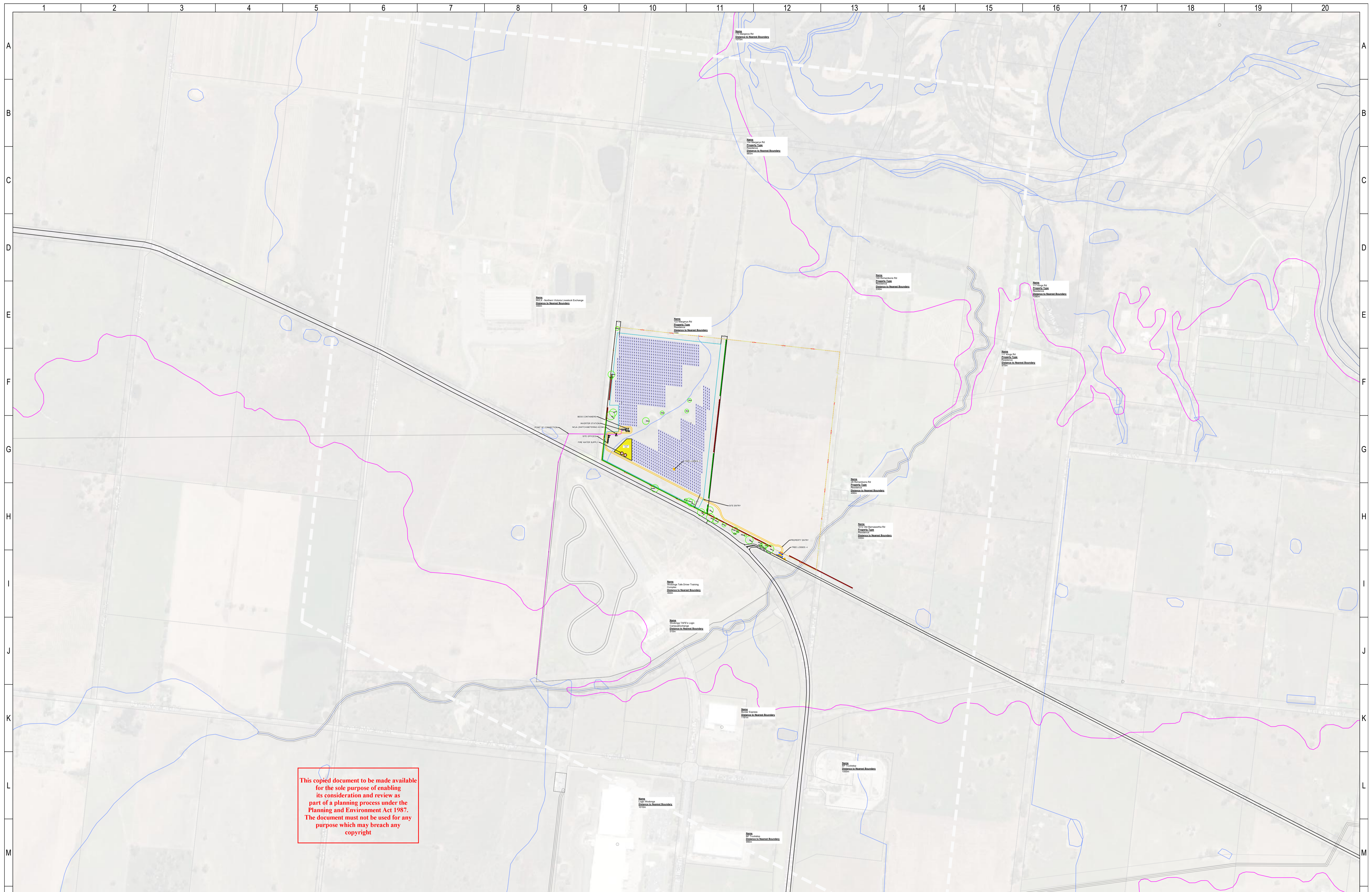

This copied document to be made available for the sole purpose of enabling its consideration and review as part of a planning process under the Planning and Environment Act 1987. The document must not be used for any purpose which may breach any copyright

SYSTEM DETAILS		PANELS		INVERTER	
SIZE (DC):	TBC	MFR :	TBC	MFR:	SUNGROW
SIZE (AC):	4950 kW	MODEL:	TBC	MODEL:	SG2475HV
DC/AC RATIO:	1.73	POWER:	TBC	POWER:	2475kWAC
PITCH:	6.00 M	QUANTITY:	TBC	QUANTITY:	2

LEGEND	
	PV TRACKER
	UNDERGROUND 22KV CABLE
	OVERHEAD 22KV CABLE
	CFA SETBACK (10 METRE)
	1 KM OFFSET
	FENCING (EXISTING)
	SECURITY FENCING
	SCREEN PLANTING
	TREE LOSSES
	NATIVE VEGETATION TPZ

ADVERTISED PLAN

REV	DESCRIPTION	BY	DATE
A	PRELIMINARY DESIGN	DA	21-07-23

DRAWN	DATE
DA	21-07-23
CHECKED	DATE
MD	21-07-23
VERIFIED	DATE
MD	21-07-23
BY	DATE
BY	DATE

PROJECT: BARNAWARTH NORTH SOLAR FARM
 154 MARGERYS ROAD BARNAWARTH NORTH VIC 3699
 TITLE: SITE LAYOUT
 SHEET 2
 JOB No: SPAU011 DWG No: E002 SCALE: 1:6000

This copied document to be made available for the sole purpose of enabling its consideration and review as part of a planning process under the Planning and Environment Act 1987. The document must not be used for any purpose which may breach any copyright

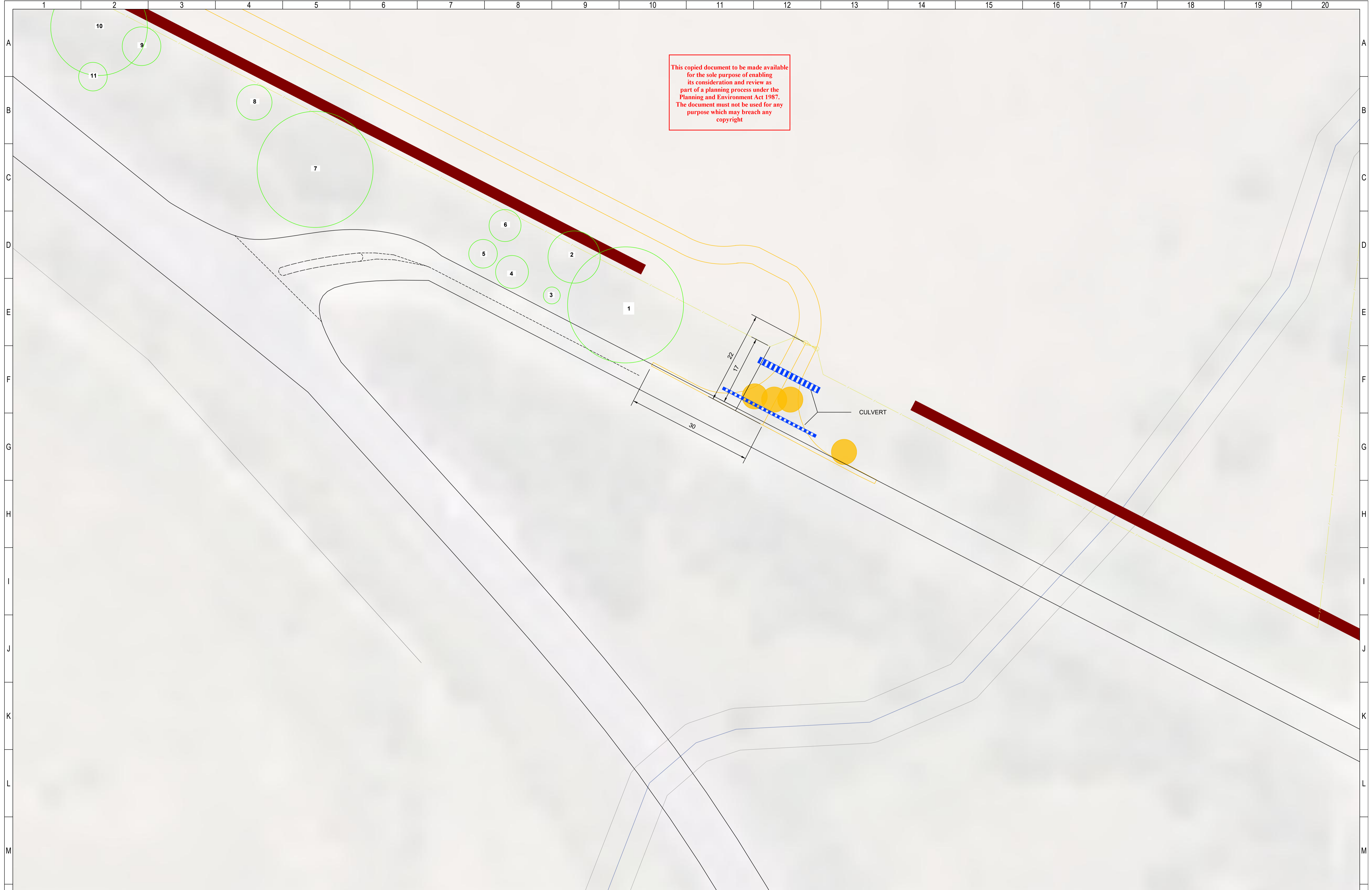

ADVERTISED PLAN

SYSTEM DETAILS		PANELS		INVERTER		LEGEND	
SIZE (DC):	TBC	MFR.:	-	MFR.:	SUNGROW		SECURITY FENCING
SIZE (AC):	4950 kW	MODEL:	-	MODEL:	SG2475HV		SCREEN PLANTING
DC/AC RATIO:	TBC	POWER:	TBC	POWER:	2475kWAC		GATE
PITCH:	TBC	QUANTITY:	-	QUANTITY:	2		TREE LOSSES
							NATIVE VEGETATION TPZ

NOTES			

REV	DESCRIPTION	BY	DATE
A	PRELIMINARY DESIGN	DA	21-07-23

DRAWN		CHECKED		VERIFIED	
DA	21-07-23	MD	21-07-23	MD	21-07-23
BY	DATE	BY	DATE	BY	DATE
DA	21-07-23	MD	21-07-23	MD	21-07-23

PROJECT: BARNAWARTHA NORTH SOLAR FARM
 154 MARGERYS ROAD BARNAWARTHA NORTH VIC 3691
 TITLE: SITE LAYOUT
 SHEET 4
 JOB No: SPAU011 DWG No: E004 SCALE: -

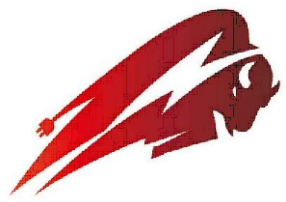

PAPER SIZE: A1
 REV: A

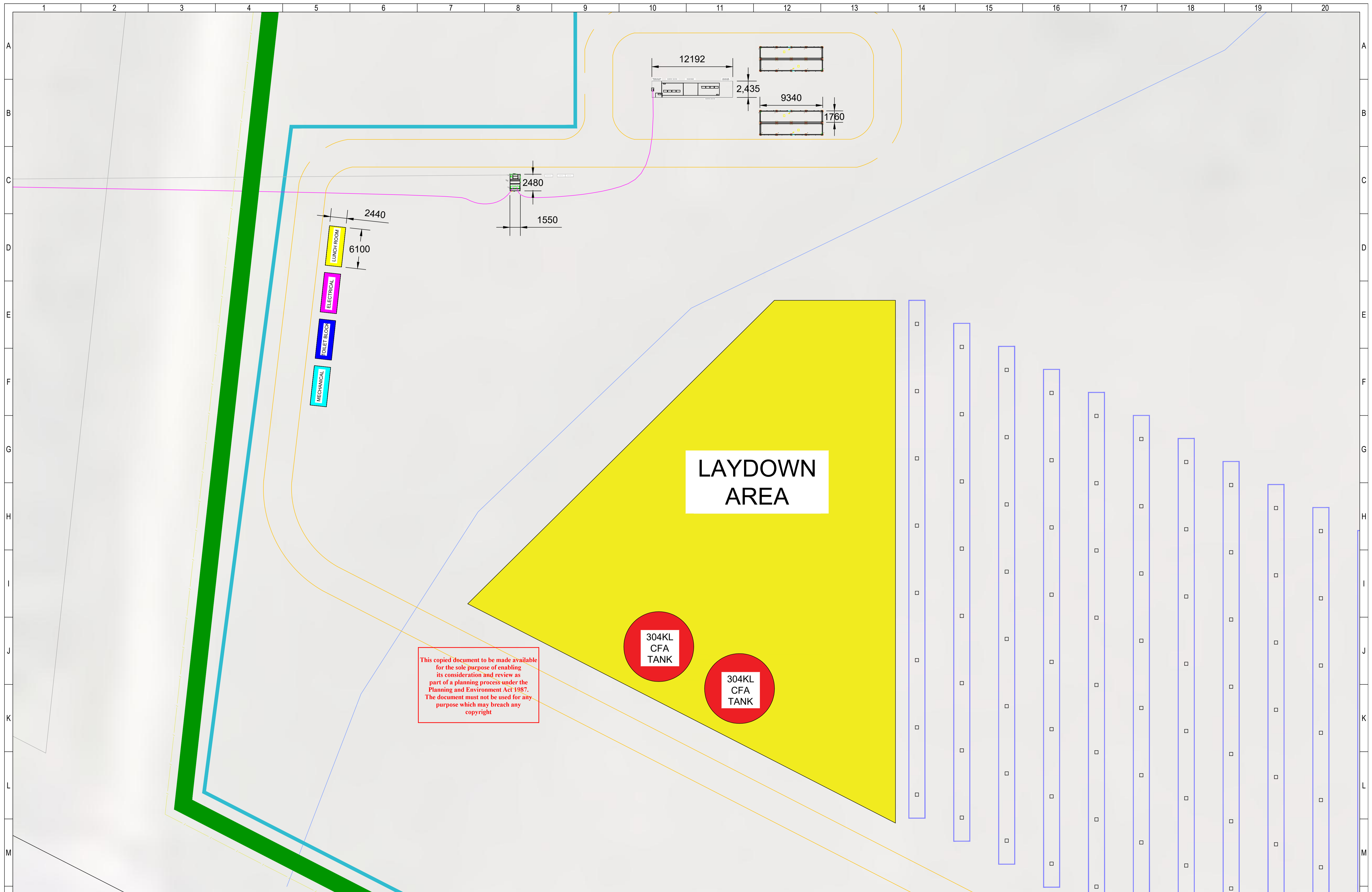

This copied document to be made available for the sole purpose of enabling its consideration and review as part of a planning process under the Planning and Environment Act 1987. The document must not be used for any purpose which may breach any copyright

LAYDOWN AREA

304KL CFA TANK

304KL CFA TANK

SYSTEM DETAILS		PANELS		INVERTER		LEGEND	
SIZE (DC):	TBC	MFR :	-	MFR:	SUNGROW		SECURITY FENCING
SIZE (AC):	4950 kW	MODEL:	-	MODEL:	SG2475HV		SCREEN PLANTING
DC/AC RATIO:	TBC	POWER:	TBC	POWER:	2475kWAC		GATE
PITCH:	TBC	QUANTITY:	-	QUANTITY:	2		TREE LOSSES
							NATIVE VEGETATION TPZ

ADVERTISED PLAN

REV	DESCRIPTION	BY	DATE
A	PRELIMINARY DESIGN	DA	16-08-23

DRAWN	DATE
DA	21-07-23
CHECKED	MD
VERIFIED	MD
BY	DATE
PRELIMINARY	

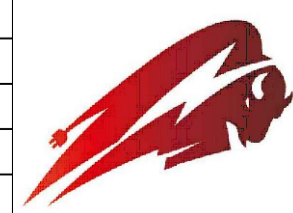

PROJECT:	BARNAWARTHA NORTH SOLAR FARM	PAPER SIZE:	A1
154 MARGERYS ROAD BARNAWARTHA NORTH VIC 3691			
TITLE:	SITE LAYOUT	REV:	A
	SHEET 5		
JOB No:	SPA0011	DWG No:	E005
SCALE:	-		

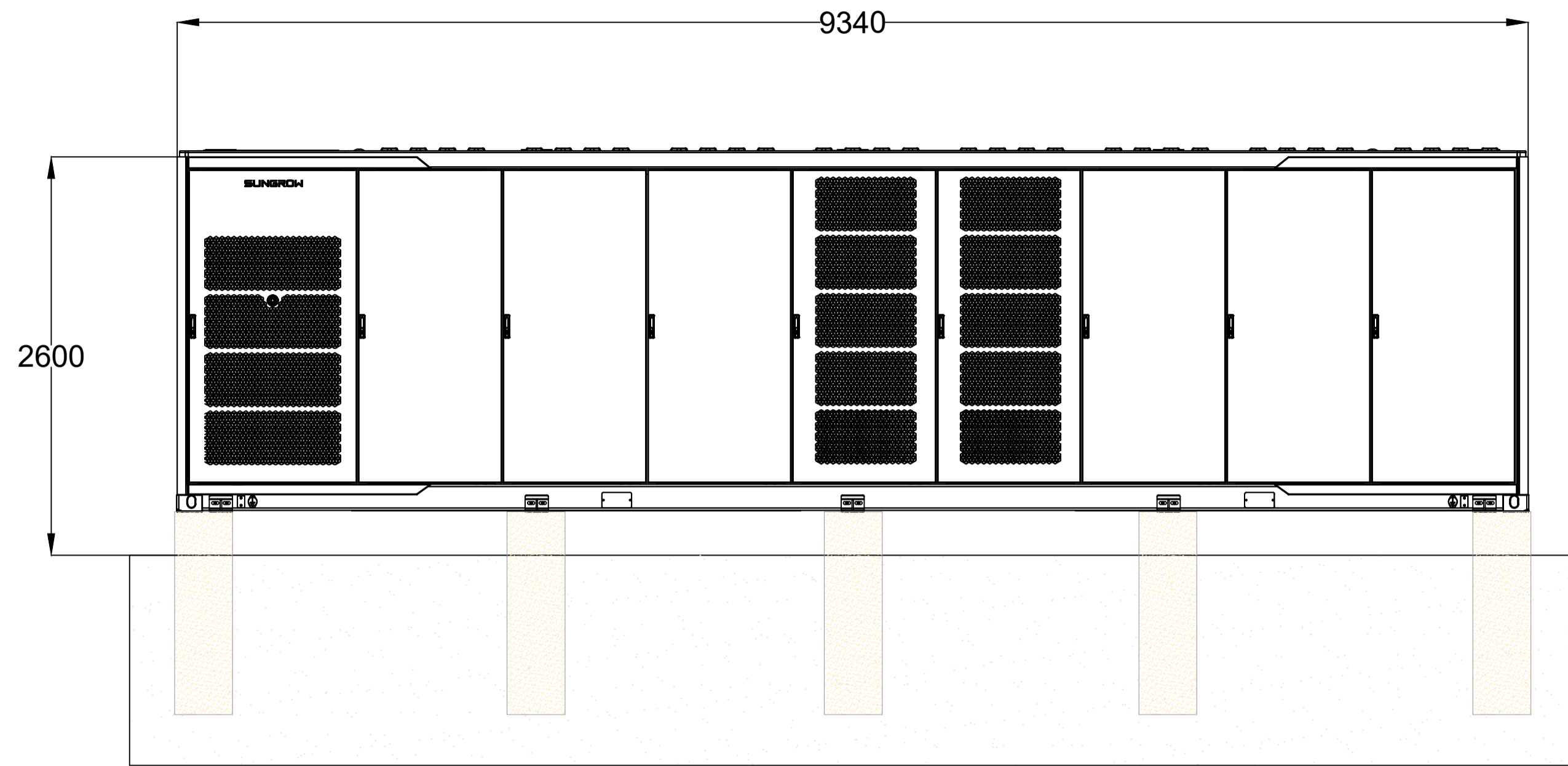

FRONT VIEW

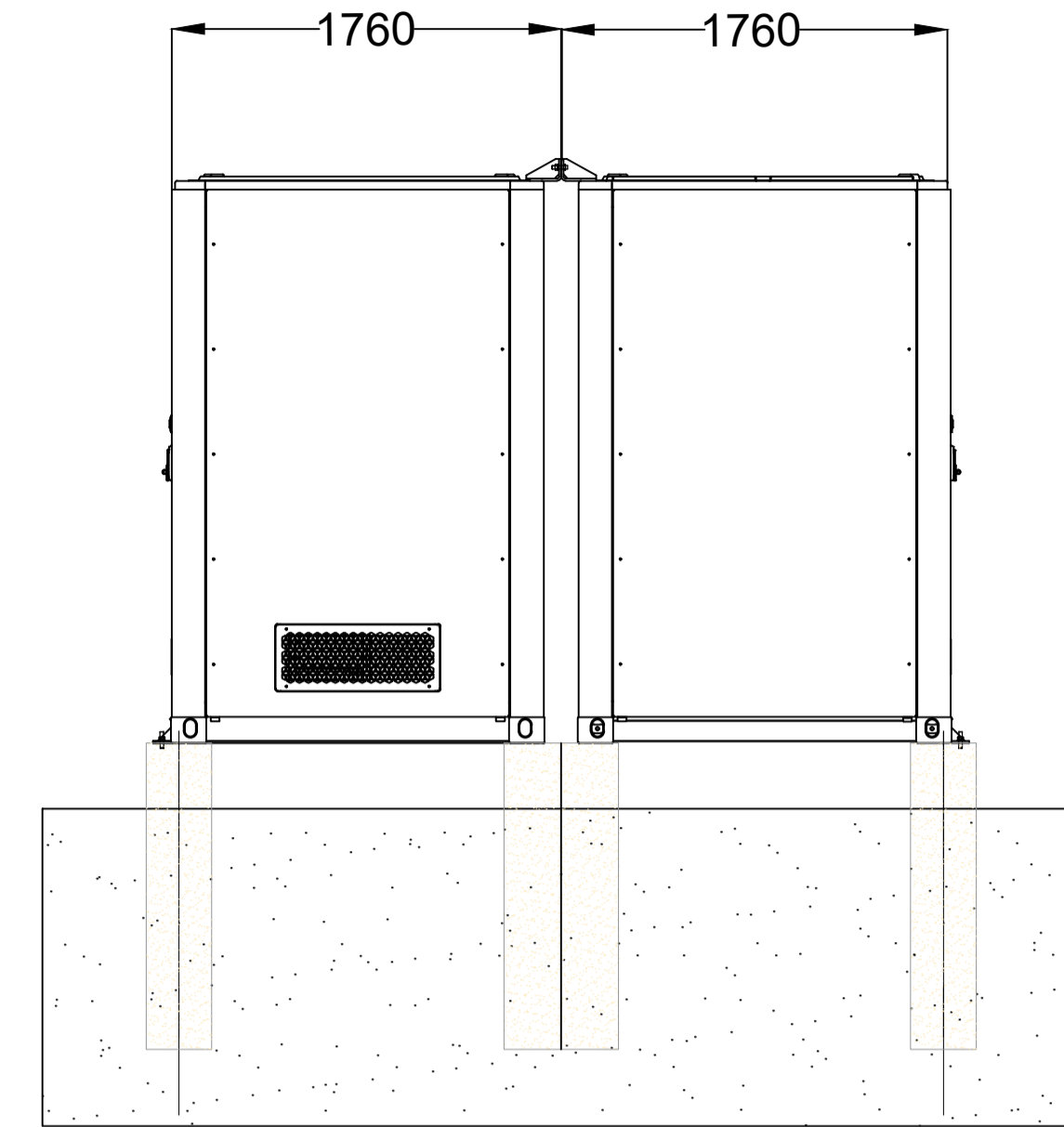

SIDE VIEW



BESS STATION

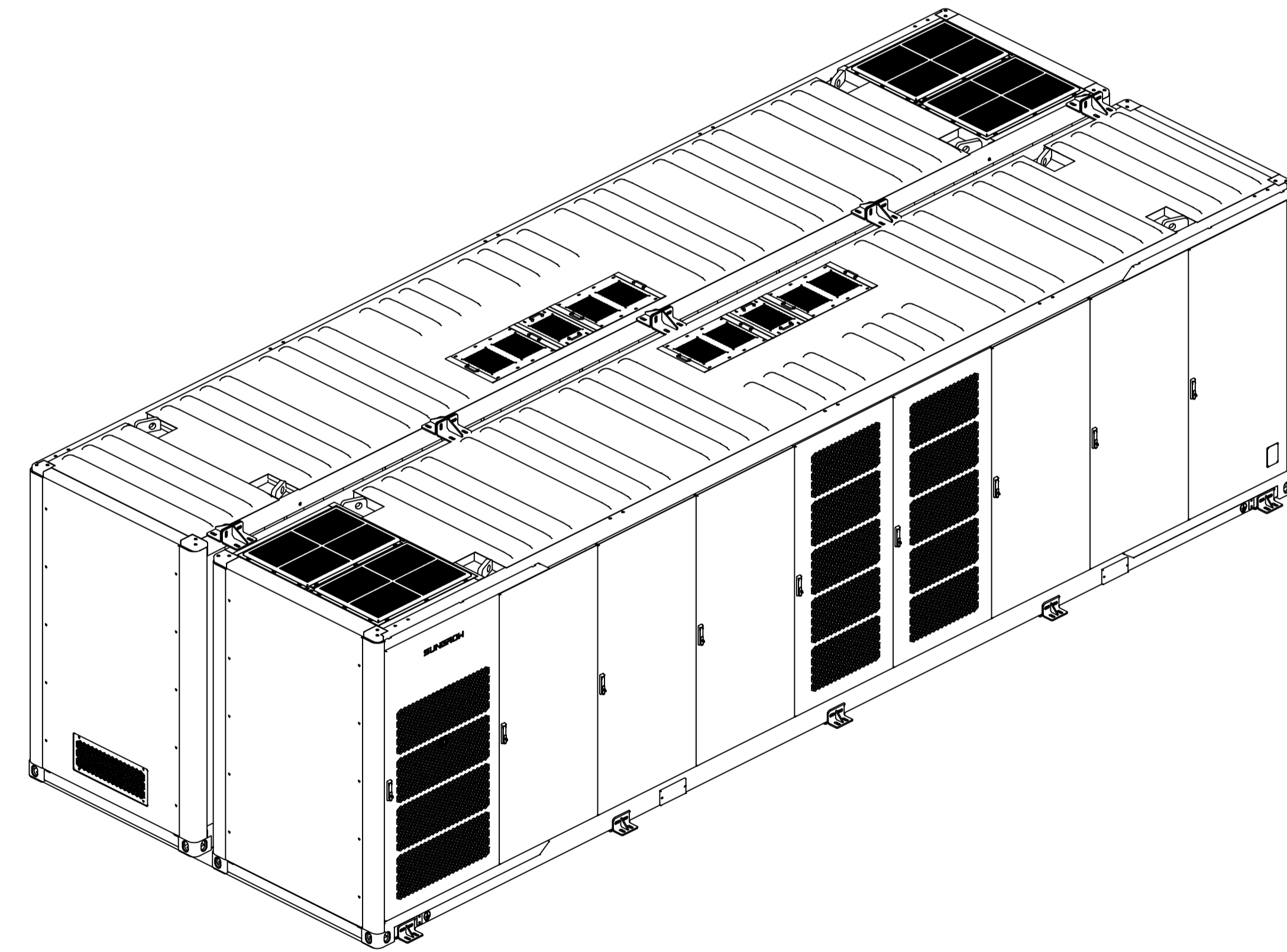

ISOMETRIC VIEW - 2 CONTAINERS

This copied document to be made available for the sole purpose of enabling its consideration and review as part of a planning process under the Planning and Environment Act 1987. The document must not be used for any purpose which may breach any copyright

ADVERTISED PLAN

NOTES

				DRAWN	DA	22-08-23
				CHECKED	MD	22-08-23
				VERIFIED	MD	22-08-23
A	FIRST ISSUE	DA	22-08-23	BY	DATE	
REV	DESCRIPTION	BY	DATE	PRELIMINARY		

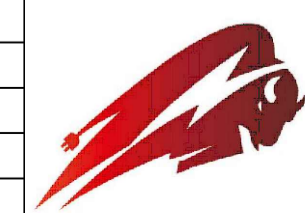

PROJECT:	BARNAWARTHA NORTH SOLAR FARM	PAPER SIZE:	A1
154 MARGERYS ROAD BARNAWARTHA NORTH VIC 3691			
TITLE:	INFRASTRUCTURE ELEVATIONS	REV:	A
SHEET 1 - BESS CONTAINER			
JOB No: SPAU011	DWG No: E010	SCALE:	

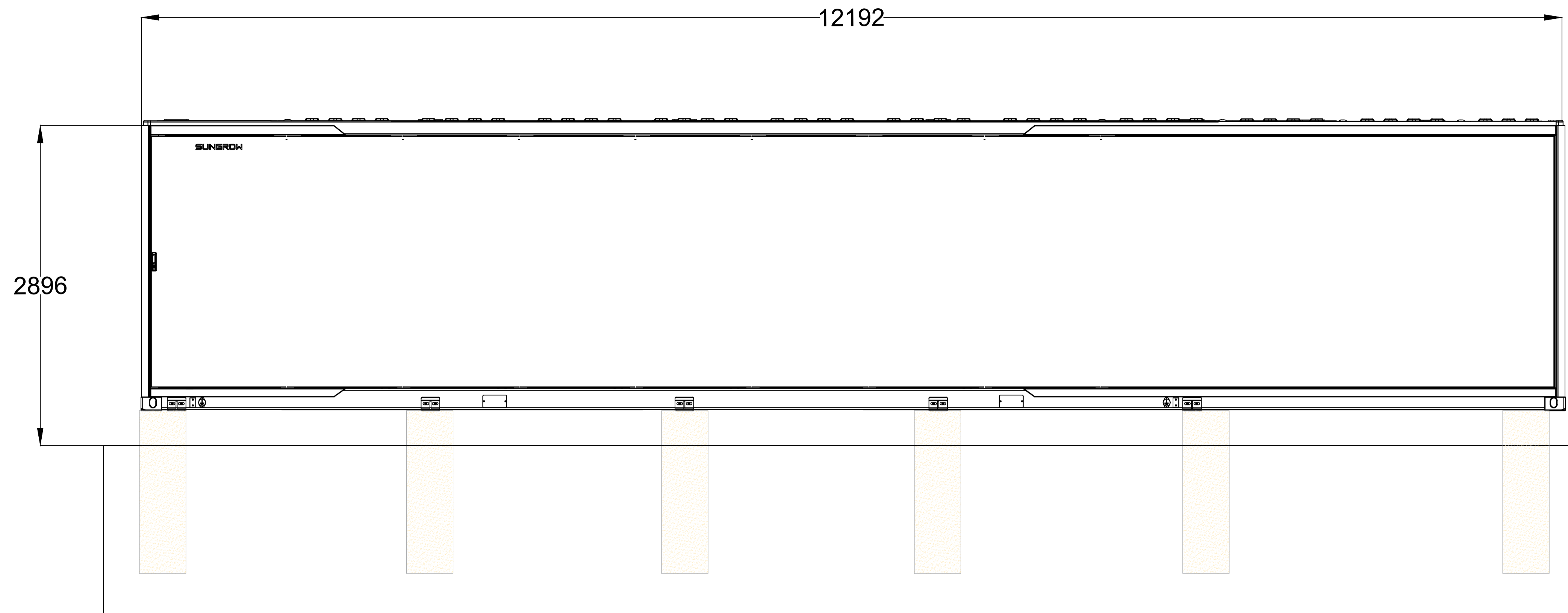

FRONT VIEW

ADVERTISED
PLAN

This copied document to be made available for the sole purpose of enabling its consideration and review as part of a planning process under the Planning and Environment Act 1987. The document must not be used for any purpose which may breach any copyright

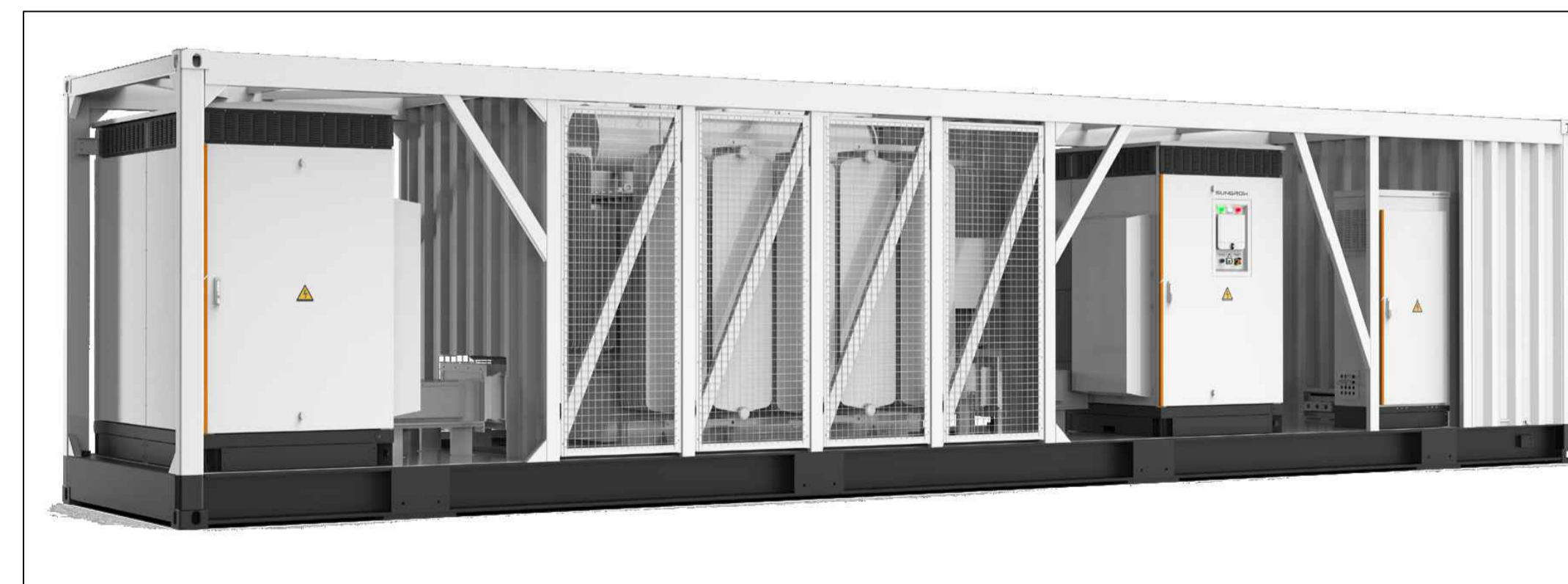

INVERTER STATION

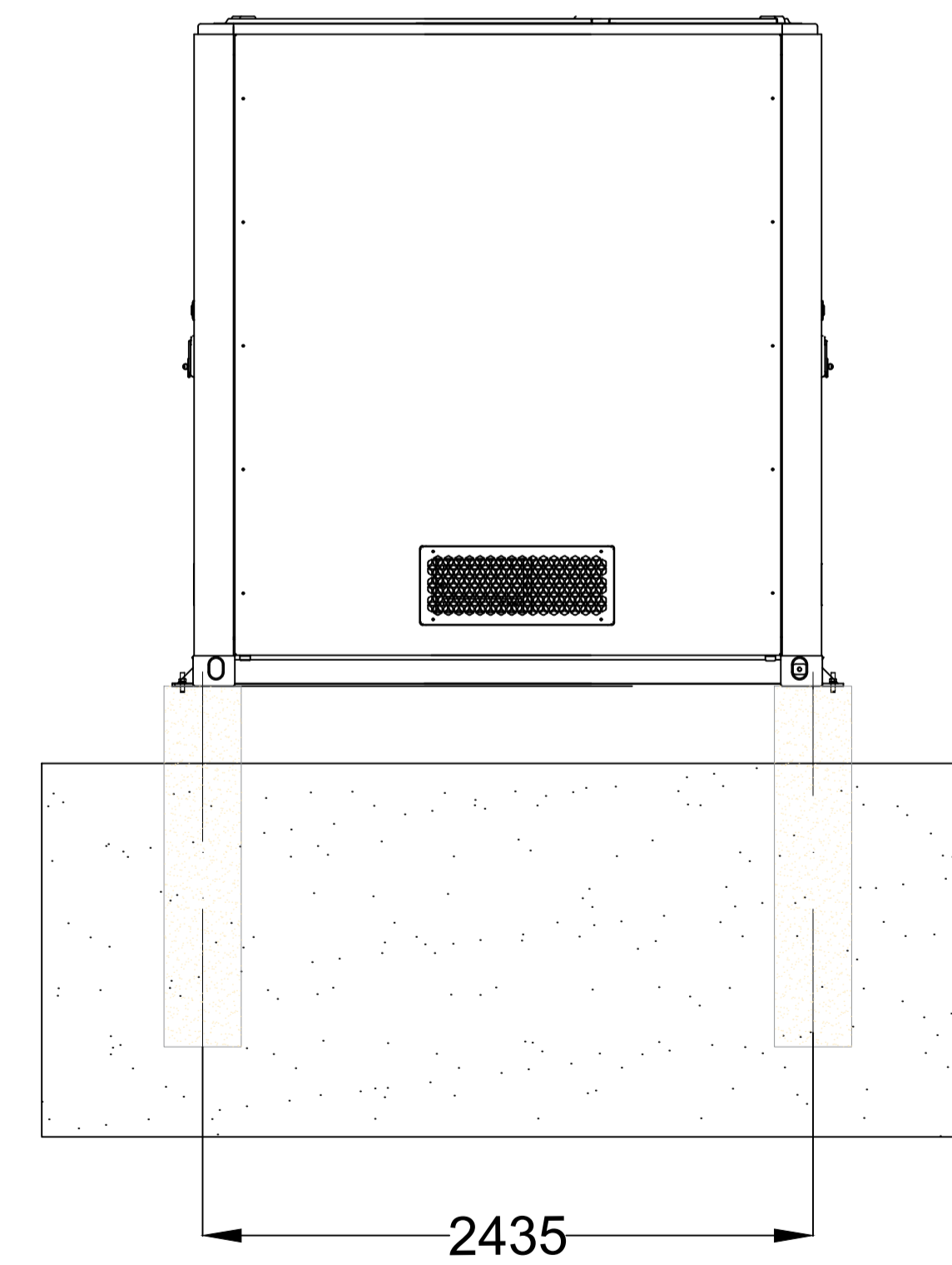

SIDE VIEW

NOTES

REV	DESCRIPTION	BY	DATE	DRAWN	DA	22-08-23
				CHECKED	MD	22-08-23
				VERIFIED	MD	22-08-23
A	FIRST ISSUE	DA	22-08-23		BY	DATE
				PRELIMINARY		

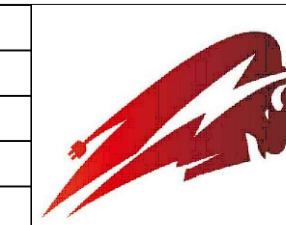

PROJECT:	BARNAWARTHA NORTH SOLAR FARM	PAPER SIZE:	A1
154 MARGERYS ROAD BARNAWARTHA NORTH VIC 3691			
TITLE:	INFRASTRUCTURE ELEVATIONS	REV:	A
SHEET 2 - INVERTER CONTAINER			
JOB No: SPAU011	DWG No: E011	SCALE:	

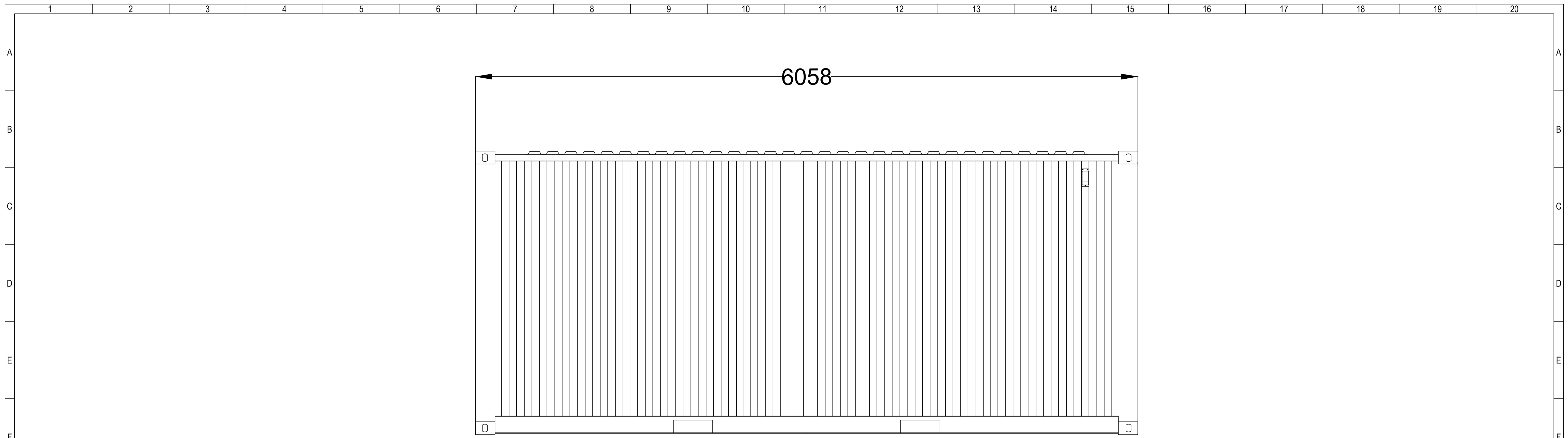

FRONT VIEW

ADVERTISED
PLAN



20 FOOT SHIPPING CONTAINER OFFICE

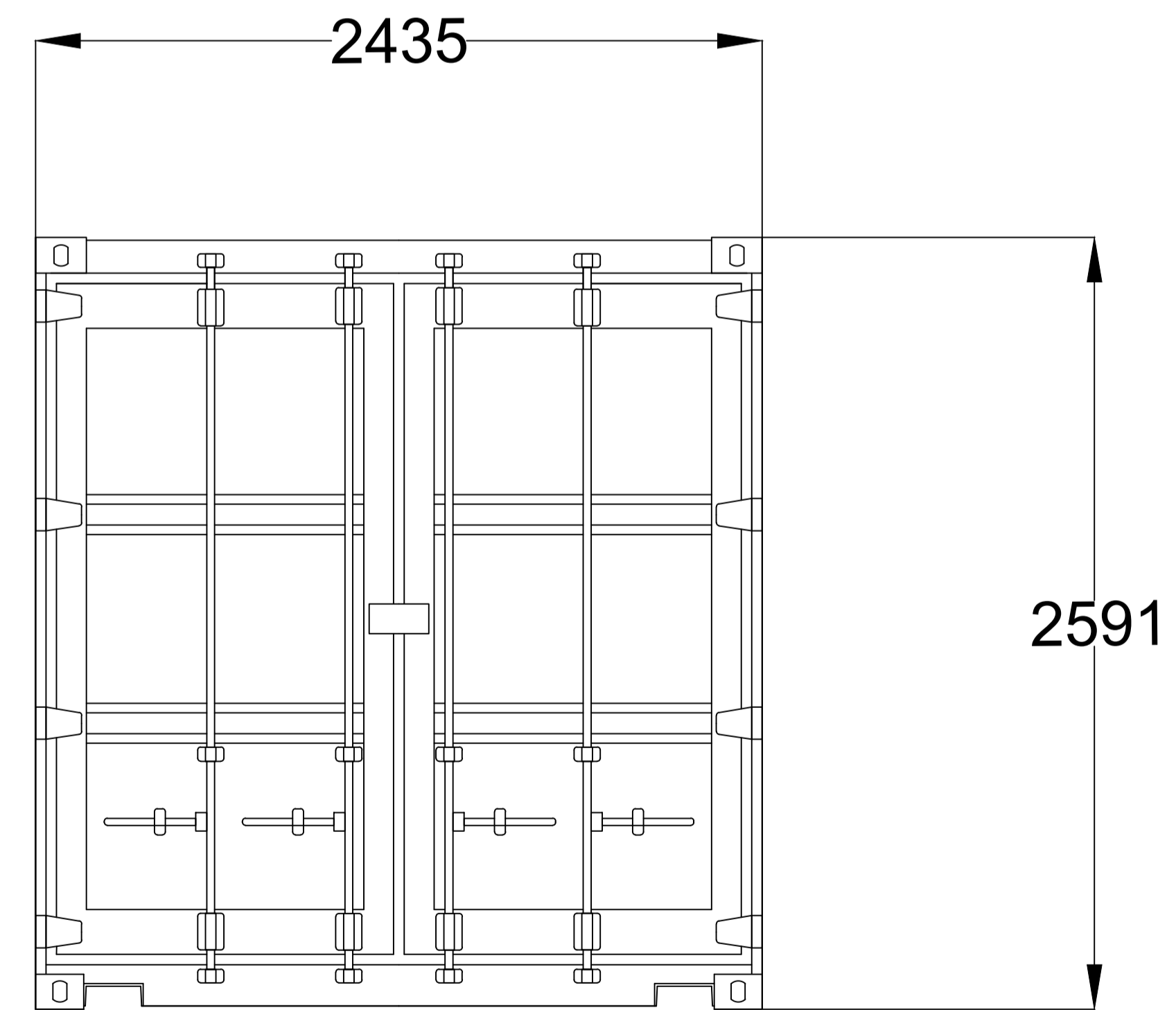

SIDE VIEW

This copied document to be made available for the sole purpose of enabling its consideration and review as part of a planning process under the Planning and Environment Act 1987. The document must not be used for any purpose which may breach any copyright

NOTES

1	2	3	4	5	6	7	8	9	10	11
---	---	---	---	---	---	---	---	---	----	----

	DRAWN	DA	22-08-23
	CHECKED	MD	22-08-23
	VERIFIED	MD	22-08-23
A	FIRST ISSUE	DA	22-08-23
REV	DESCRIPTION	BY	DATE
			PRELIMINARY

PROJECT: BARNAWARTH NORTH SOLAR FARM
 154 MARGERYS ROAD BARNAWARTH NORTH VIC 3691
 TITLE: INFRASTRUCTURE ELEVATIONS
 SHEET 3 - SITE OFFICES

JOB No: SPAU011 DWG No: E012 SCALE: -

PAPER SIZE: A1
 REV: A

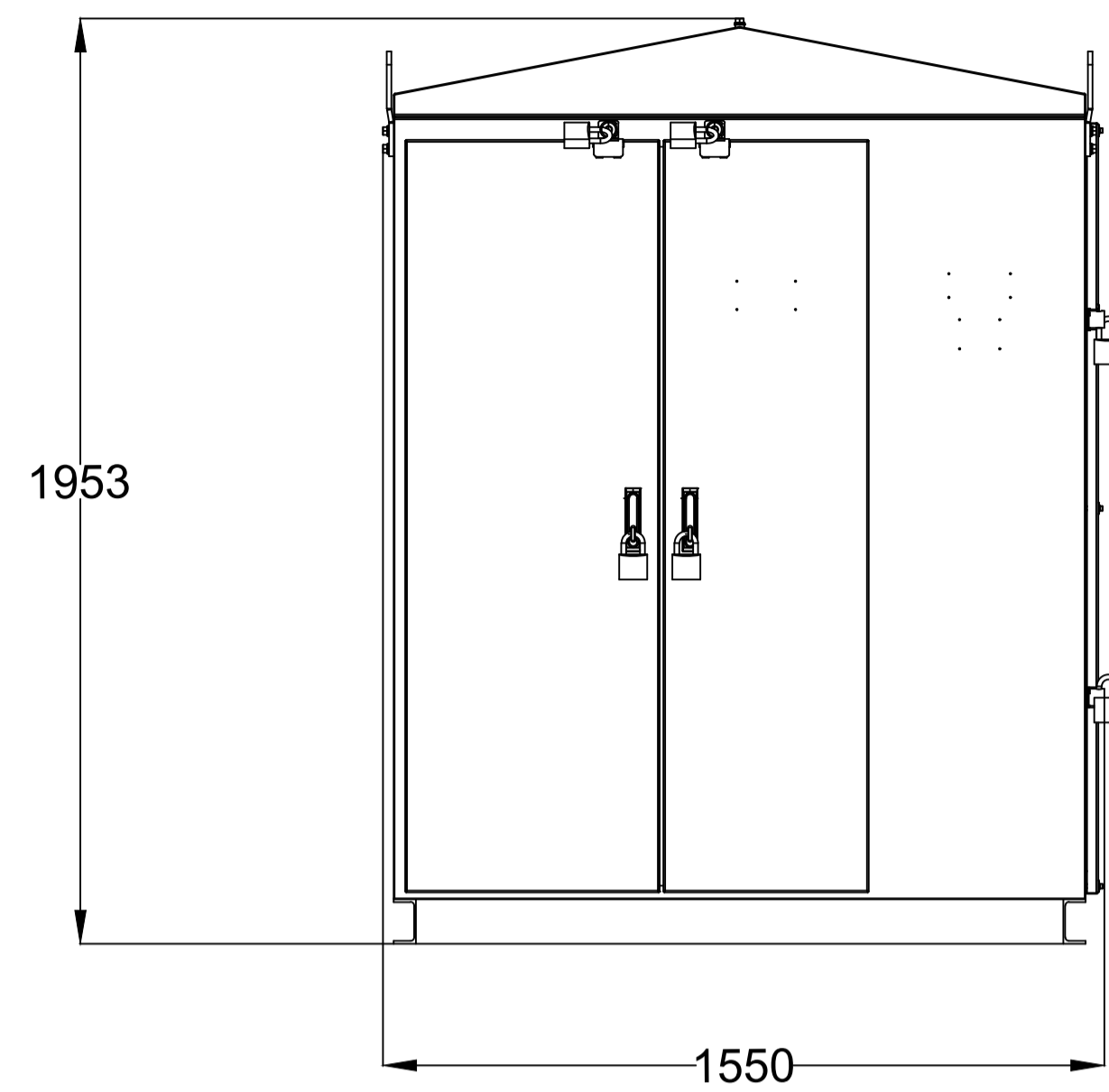

FRONT VIEW

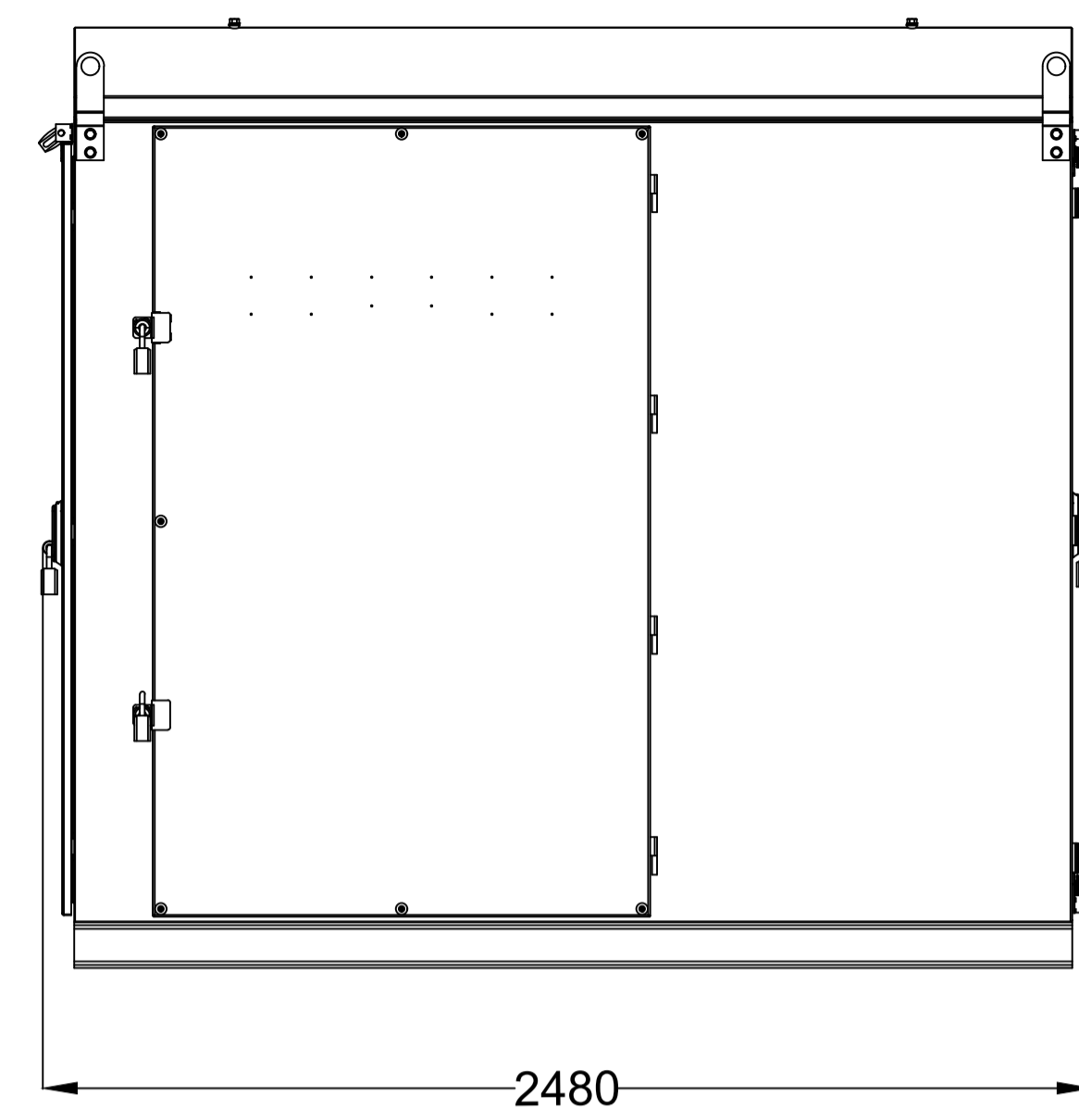

SIDE VIEW

This copied document to be made available for the sole purpose of enabling its consideration and review as part of a planning process under the Planning and Environment Act 1987. The document must not be used for any purpose which may breach any copyright



NOJA UNIT (MAIN SWITCH)

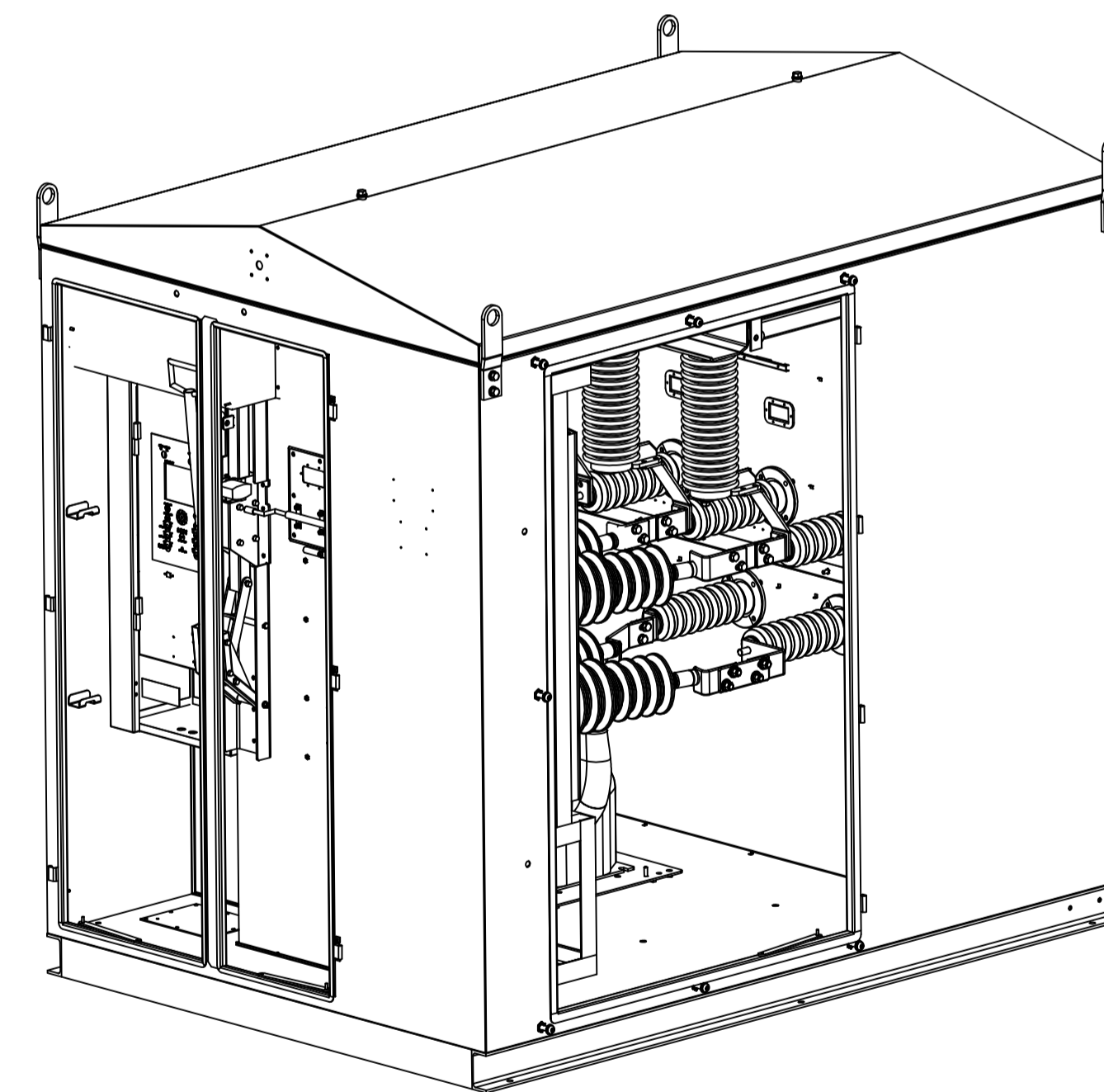

ISOMETRIC VIEW

ADVERTISED PLAN

NOTES

REV	DESCRIPTION	BY	DATE	DRAWN	DA	22-08-23
A	FIRST ISSUE	DA	22-08-23	CHECKED	MD	22-08-23
				VERIFIED	MD	22-08-23
				BY	MD	DATE
PRELIMINARY						

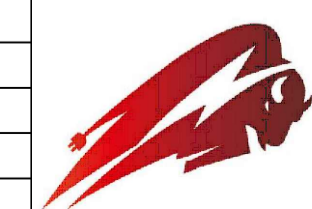

PROJECT:	BARNAWARTHA NORTH SOLAR FARM	PAPER SIZE:	A1
154 MARGERYS ROAD BARNAWARTHA NORTH VIC 3691			
TITLE:	INFRASTRUCTURE ELEVATIONS	REV:	A
	SHEET 4 - NOJA UNIT		
JOB No:	SPAU011	DWG No:	E013
		SCALE:	-

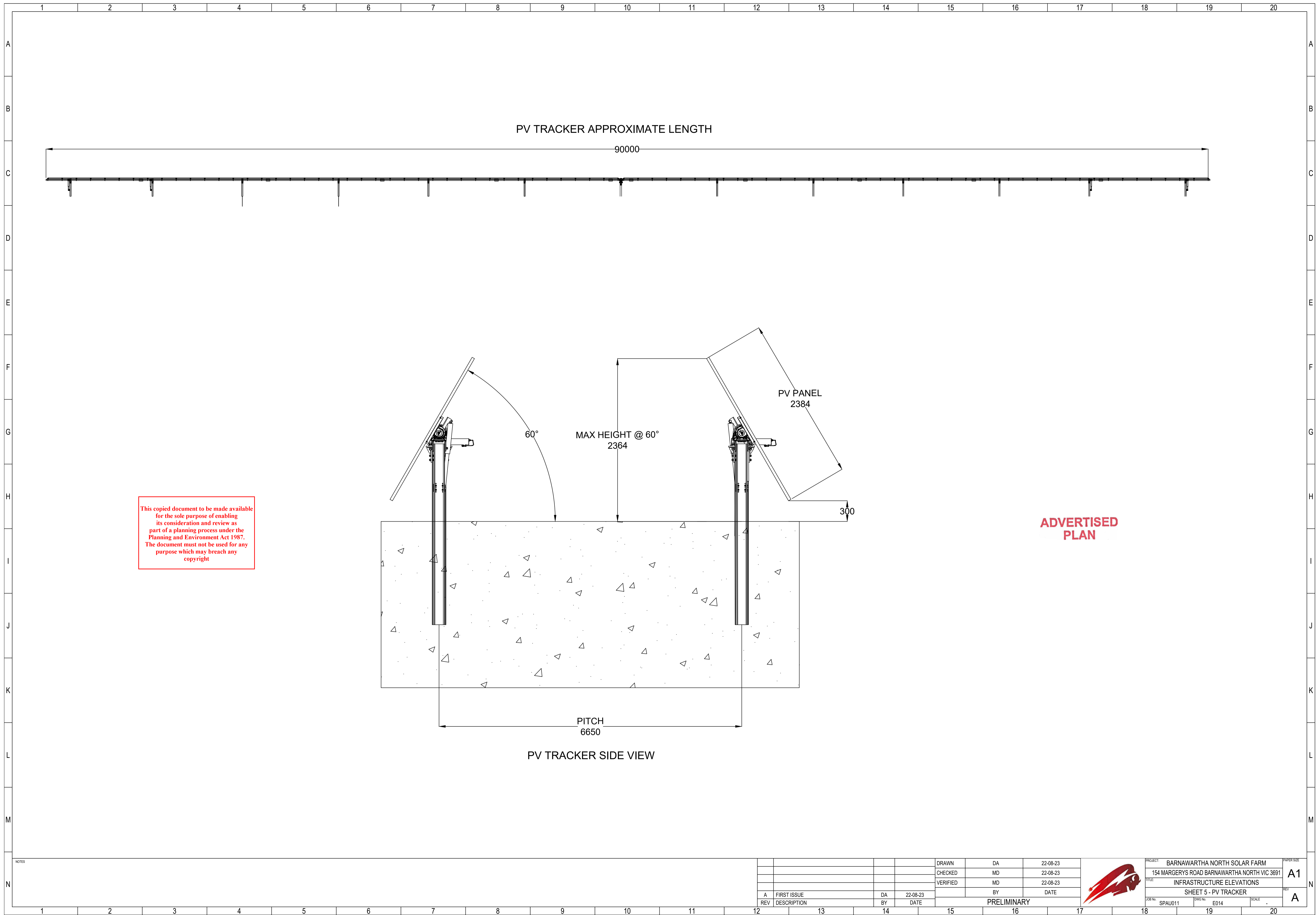

PV TRACKER APPROXIMATE LENGTH

90000

PV PANEL
2384

60°

MAX HEIGHT @ 60°
2364

300

This copied document to be made available for the sole purpose of enabling its consideration and review as part of a planning process under the Planning and Environment Act 1987. The document must not be used for any purpose which may breach any copyright

ADVERTISED
PLAN

PITCH
6650

PV TRACKER SIDE VIEW

NOTES

				DRAWN	DA	22-08-23
				CHECKED	MD	22-08-23
				VERIFIED	MD	22-08-23
A	FIRST ISSUE	DA	22-08-23	BY	DATE	
REV	DESCRIPTION	BY	DATE	PRELIMINARY		

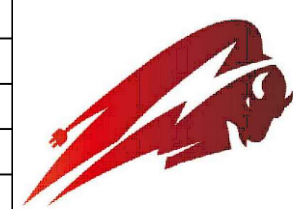

PROJECT:	BARNAWARTHA NORTH SOLAR FARM	PAPER SIZE:	A1
154 MARGERYS ROAD BARNAWARTHA NORTH VIC 3691			
TITLE:	INFRASTRUCTURE ELEVATIONS	REV:	A
SHEET 5 - PV TRACKER			
JOB No: SPAU011	DWG No: E014	SCALE:	-

This copied document to be made available for the sole purpose of enabling its consideration and review as part of a planning process under the Planning and Environment Act 1987. The document must not be used for any purpose which may breach any copyright

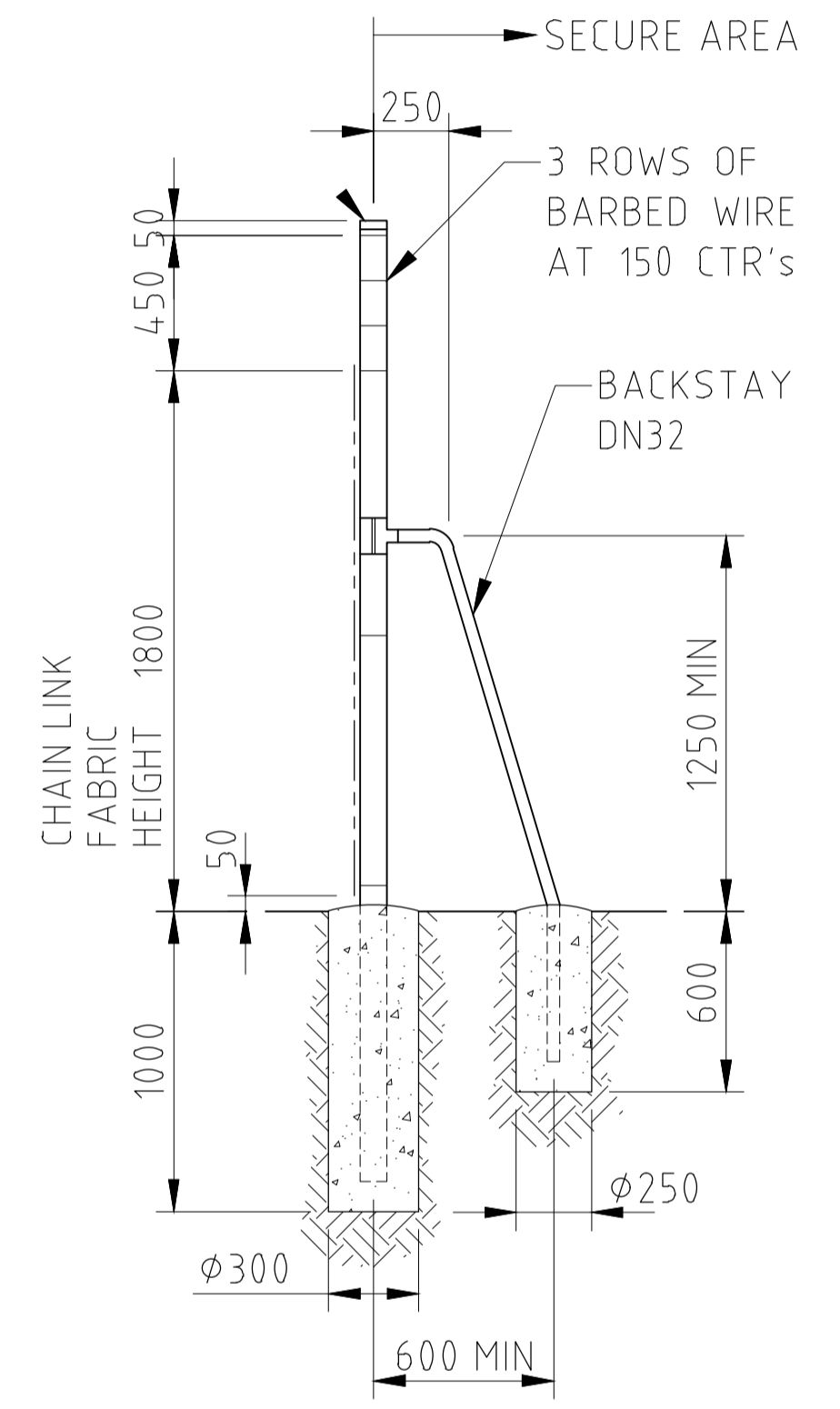
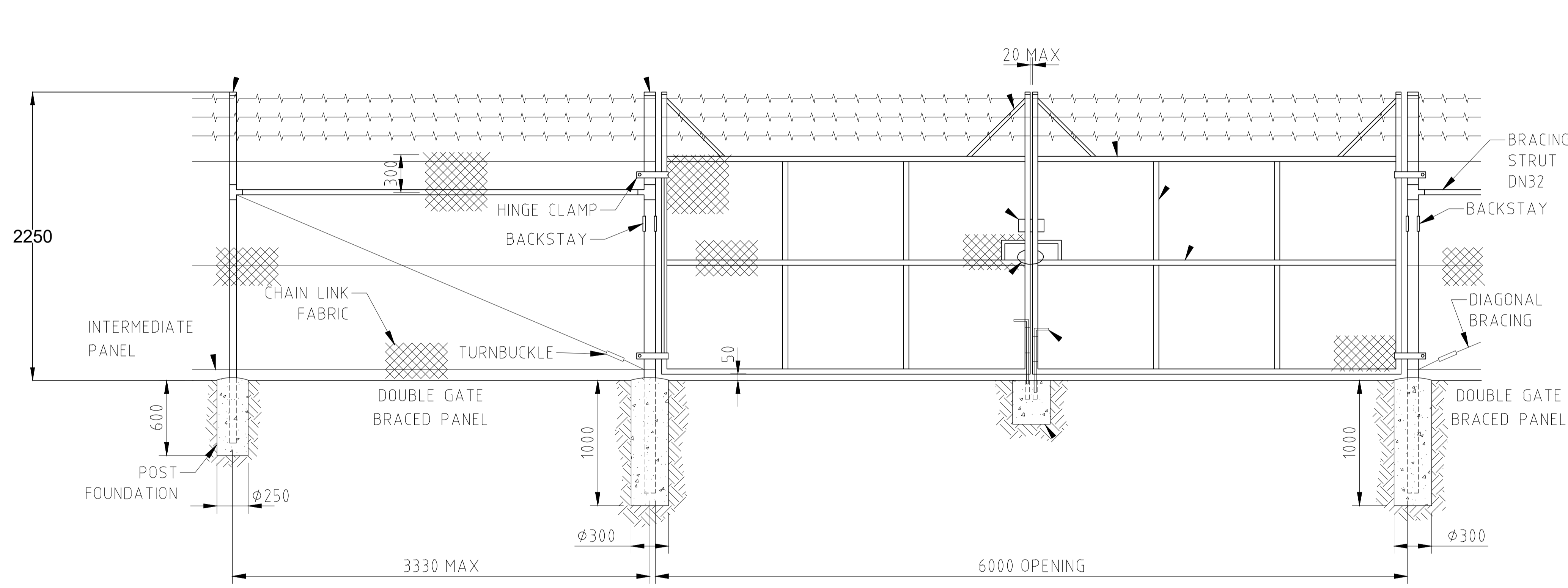

ADVERTISED PLAN

NOTES

REV	DESCRIPTION	BY	DATE
A	FIRST ISSUE	DA	22-08-23

DRAWN	DA	22-08-23
CHECKED	MD	22-08-23
VERIFIED	MD	22-08-23
BY	DA	DATE
PRELIMINARY		

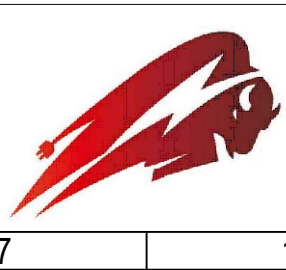

PROJECT:	BARNAWARTHA NORTH SOLAR FARM	PAPER SIZE:	A1
154 MARGERYS ROAD BARNAWARTHA NORTH VIC 3691			
TITLE:	INFRASTRUCTURE ELEVATIONS	REV:	A
SHEET 6 - FENCING DETAIL			
JOB No: SPAU011	DWG No: E015	SCALE:	-